

# LeCroy 1996 Test & Measurement Products



**LeCroy**

*Innovators in Instrumentation*



# Innovative Thinking



**LeCroy**

Innovators in Instrumentation

Dear Fellow Engineer,

At LeCroy, innovative thinking has led to award winning product design. Over the past ten years, we have been recognized throughout the world as a leader in the Test & Measurement industry with eight IR-100 (R&D 100) Product Awards, *Test & Measurement Magazine's* Best In Test Award, Top Ten Technology Award from *Laser & Optronics* and Product of the Year Award from *Design News*.

Our engineers not only develop the most innovative technology, but also strive to find new measurement solutions that meet your industry needs. Designing test & measurement instruments is our primary business, so our research and development efforts are continuously focused on delivering the powerful and accurate tools you require to perform your design and research work most effectively – thereby helping you to increase your productivity and reduce your company's product-to-market cycle for a greater competitive advantage.

Innovative product design has enabled LeCroy to set the industry standard for DSO memory length four times and sample rates twice. We've designed the world's fastest and most powerful digital scopes and the first truly easy-to-use Arbitrary Waveform Generator. Our screen sizes are up to 50% larger – allowing you to display your signal details more accurately and evaluate the results more easily. New product features and options allow you to capture, view, measure, analyze and document signals with more ease and power. This can be a real help in meeting ISO 9000 quality standards.

At LeCroy, we believe that it's the right combination of price, technology, quality, ease-of-use and reliable service that provide the true formula for increased performance. Our engineers have designed products to help Nobel Prize winning scientists here on earth as well as astronauts on their way to outer space. We welcome you to our 1996 Test & Measurement Catalog and look forward to seeing how LeCroy technology can work for you.

Sincerely,

Walter LeCroy



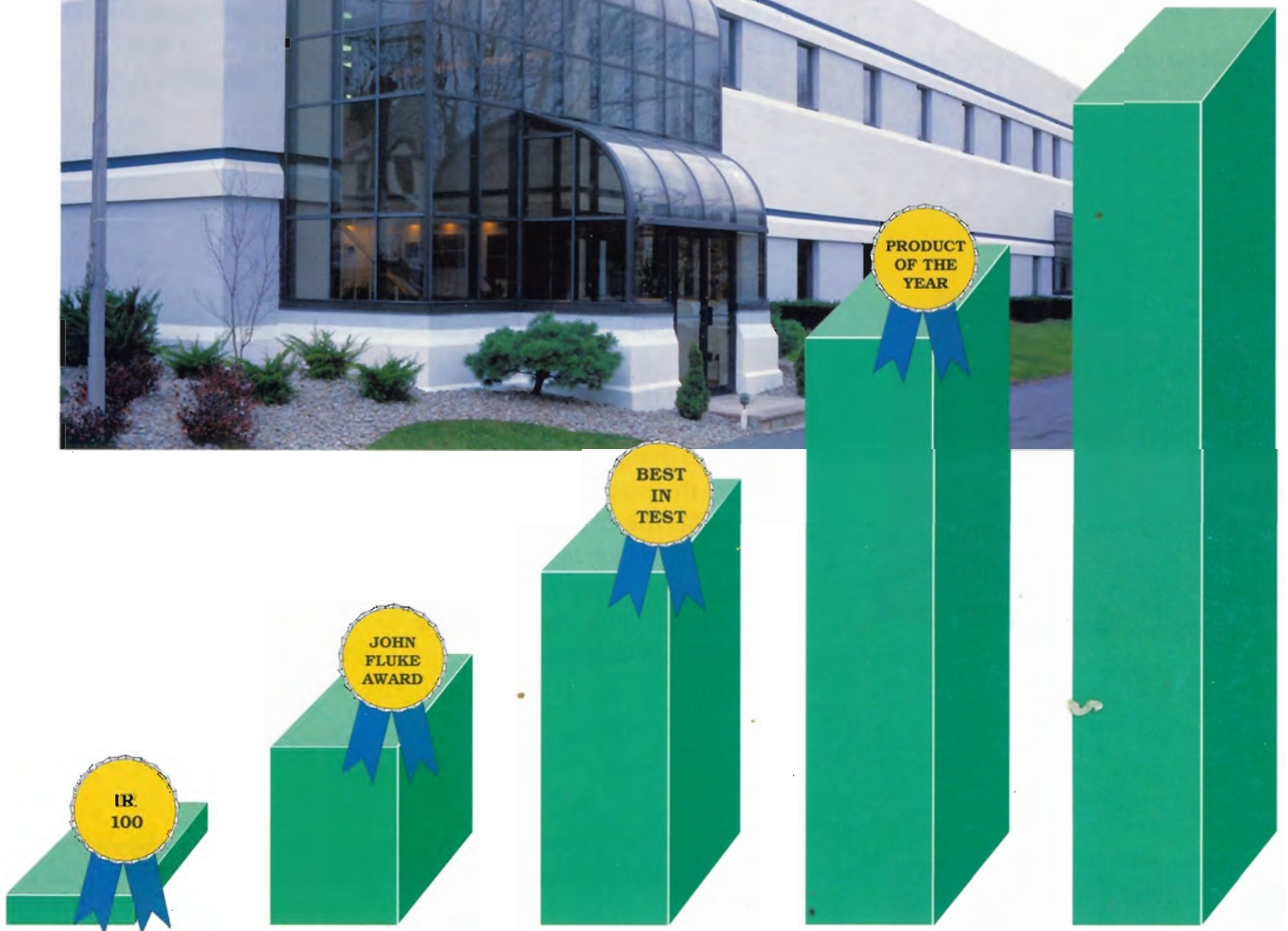

**1986**                      **1992**                      **1993**                      **1994**                      **1995**

**Model 9400** – The first digital scope with long memory (32 times longer than competitive instruments) and large (9”) high resolution (1024 X1024) display. It was LeCroy’s first DSO and demand was overwhelming. Customers waited 18 weeks for delivery.

**John Fluke Memorial Award** to Walter LeCroy for professionalism in the test equipment industry. Only one person in the electronics industry receives this award each year for pioneering new technology and new vision in test and measurement equipment.

**Model 9360** – The first scope that could capture two signals simultaneously at 5 GS/s single shot. In the same year, LeCroy introduced the LS140 ScopeStation with many advanced features, for less than \$4000. It is awarded Best in Test.

LeCroy introduced the 9350 series which broke the record for both memory length (8 Mbytes for data acquisition) and processing power (16 Mbytes of RAM) in digital scopes.

The 9362 is the world’s fastest DSO at 10 GS/s and the 9370 series is the most powerful general purpose scope with 1 GHz bandwidth, 2 GS/s sampling, up to 8 Mbytes of data acquisition memory and up to 64 Mbytes of processing RAM.



# Application Solutions

## LeCroy Oscilloscope Technology

Capture signals with the longest memory, excellent triggering and high bandwidth.

View your signal on a large high resolution display with quad zooms and four grids.

Measure signal characteristics using over forty pulse

parameters with statistics showing their highest, lowest and average value.

Analyze your signal with a histogram package that spots and measures signal irregularities. Obtain frequency domain and other analysis from the best

FFT and advanced math packages for digital scopes.

Document your findings on floppy, SRAM memory card, PCMCIA portable hard drive, fast internal graphics printer or to GPIB, RS-232 or Centronics ports.



## Digital Design

Getting a product to market fast is extremely important. LeCroy gives the digital designer more tools to help get the job done quickly – and done right. The combination of longest acquisition memory, more accurate display, powerful triggers for troubleshooting, excellent tools for finding and measuring

intermittent signal problems and easy documentation make LeCroy scopes ideal for digital designers. The most important feature of our AWG is the easy way it allows the designer to quickly produce the test signals needed. For more information, refer to page 141, “DSOs in High Speed Electronics”.

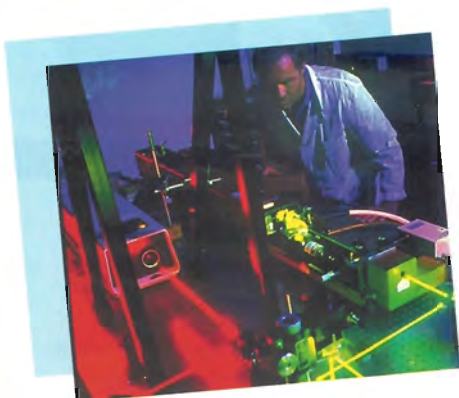

## Scientific Research

Throughout our history, we have been dedicated to helping scientific researchers improve their measurements. Eight scientists have won Nobel prizes for measurements incorporating LeCroy data acquisition. The unmatched long memory and high sampling rate of LeCroy scopes enable mass spectroscopy measurements over

wide mass ranges with high resolution. Measurements of fast pulses in high energy physics and laser research benefit from the 10 GS/s single shot sampling rate of the 9362 – the world’s fastest DSO. LeCroy also gives the scientist more software analysis capabilities for examining data.



## Communications

Whether you work with LAN, WAN, ATM, CDMA or other protocols data bursts can be most accurately captured using LeCroy's long memory. Engineers sending signals via copper, fiber or wireless methods will find LeCroy's unique Interval trigger allows jitter problems between data bits to be observed

and debugged. Packet collisions and other problems that cause data loss or data delay can be found using LeCroy's Dropout trigger. See page 171 for information on new trigger options for 155 Mbps SONET and SDH signals. Also see page 167 for "New Tools for Wireless Design".



## Disk Drive Design and Test

Magnetic Media testing is greatly enhanced by the powerful combination of LeCroy's long memory, special triggers and dedicated software packages for disk testing. The DDM (Disk Drive Measurements) and PRML options allow measurement of Resolution,

Overwrite, PW50, TAA, Autocorrelated Signal-to-Noise, Nonlinear Transition Shifts and other characteristics of interest to media testing. For more information, refer to page 157, "Making PRML Measurements".



## Microprocessor Systems

Designing computers and other microprocessor based systems requires excellent measurement of signal timing and amplitude. LeCroy scopes have more tools to spot signal irregularities, logic problems and timing jitter. The 1 GHz bandwidth of the 9370 series gives

excellent characterization of signal edges and widths. Troubleshooting of microprocessor hang ups or data delays is made much easier by Dropout and Interval triggers. For more information, refer to page 141, "DSOs in High Speed Electronics"

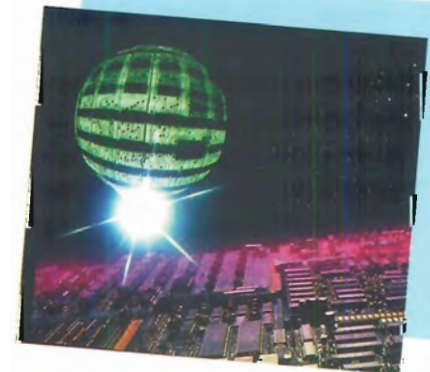



## 9362 Digital Oscilloscope

World's  
Fastest Digital  
Scope



### 10 GS/s Single Shot

The 9362 is the world's fastest digital oscilloscope. It captures real time data at 10 GS/s (100 psec per sample). This means you can see the highest level of detail on your signal and obtain the best timing resolution of closely spaced events. Scopes with slower sampling rates have the possibility of missing signal changes that happen between samples. Even if your signals are long and complex, you may still need to view a portion of your signal with world class accuracy. The 9362 is the right tool to solve this problem.

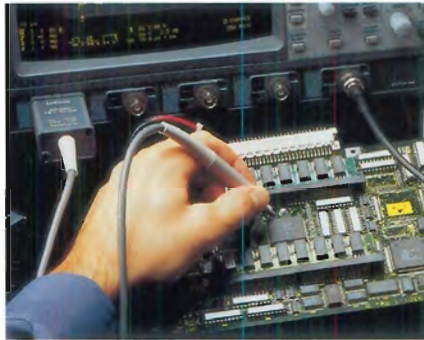

### 1.5 GHz Bandwidth

Repetitive signals do not require high single shot sampling but the accuracy of their capture is enhanced by having a high bandwidth amplifier. The 1.5 GHz front end of the 9362 means that signal rise times, overshoot characterization, pulse widths and other measurements are more accurate. If you characterize the performance of semiconductor devices, communications circuits, or other high bandwidth signals, the 1.5 GHz of the 9362 will be valuable to you.

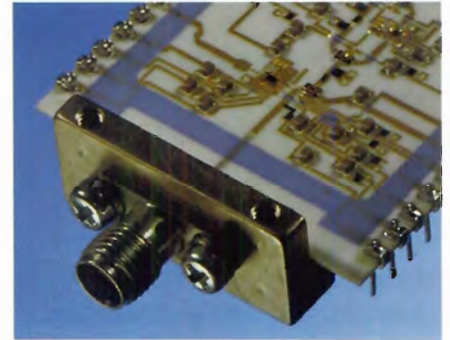

### HBT Technology

LeCroy was first in bringing the benefits of GaAs/AlGaAs technology to test instruments. The Heterojunction Bipolar Technology of the 9362 is fast, accurate and reasonably priced. Other fast sampling high bandwidth scopes are built with older, more expensive and slower technology. LeCroy has invested in advanced R&D to bring a superior product to market first, with HBT technology.



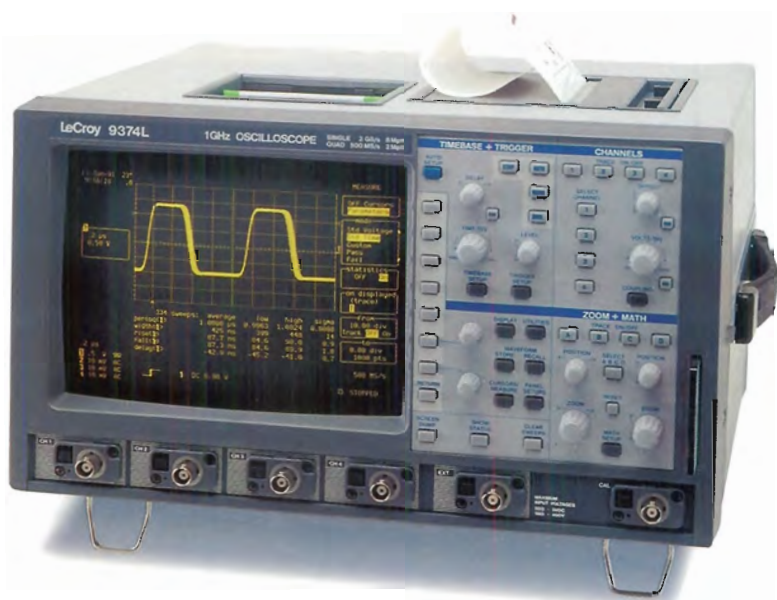

## 9370 Digital Oscilloscope

*World's Most Powerful Processing In A Digital Scope*

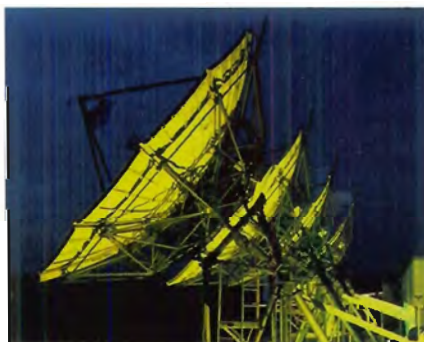

### 1 GHz Bandwidth

Typical scope users desire their test instrument to have 3 or more times bandwidth than the signal they are measuring. The 1 GHz bandwidth of the 9370 series improves accuracy of amplitude measurements on high speed signals as well as giving more accurate measurements of edge rise times and pulse widths compared to lower bandwidth scopes. It also extends the useful life of the scope as applications get faster. If you are using a 300 to 500 MHz scope now, your application will likely require faster signals in the future. Getting a 1 GHz scope will allow you to keep up.



### Long Memory

The longest signal a scope can capture using the best resolution of its ADC is the sampling period of the ADC multiplied by the memory length. More data acquisition memory means the scope can capture longer signals and put more data samples on them to obtain better detail. It also allows the capture of many fast or intermittent events into the long memory with a time stamp on each trigger. The SMARTmemory of the 9370 series automatically puts the memory onto the active signal inputs and keeps the sampling of the ADC at the highest possible rate on all timebases.

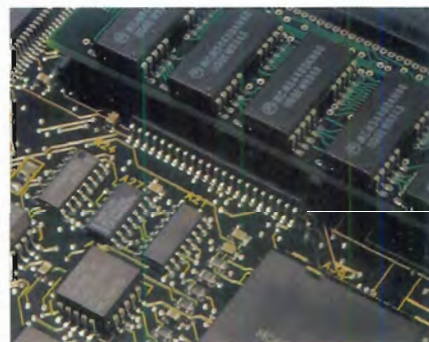

### More Powerful Processing

With up to 16 Mbytes of processing RAM, high speed processor and coprocessor and the option for up to 64 Mbytes the processing power of the 9370 series is unmatched. As an example, the 1 Mpoint FFT's that can be performed in the 9374L give 100 times better resolution in the frequency domain than competitive scopes whose processing is limited to 10K points. All math operations are performed without affecting the integrity of the raw data.



## LW420 Arbitrary Waveform Generator

World's  
Easiest-To-Use  
Signal  
Generator

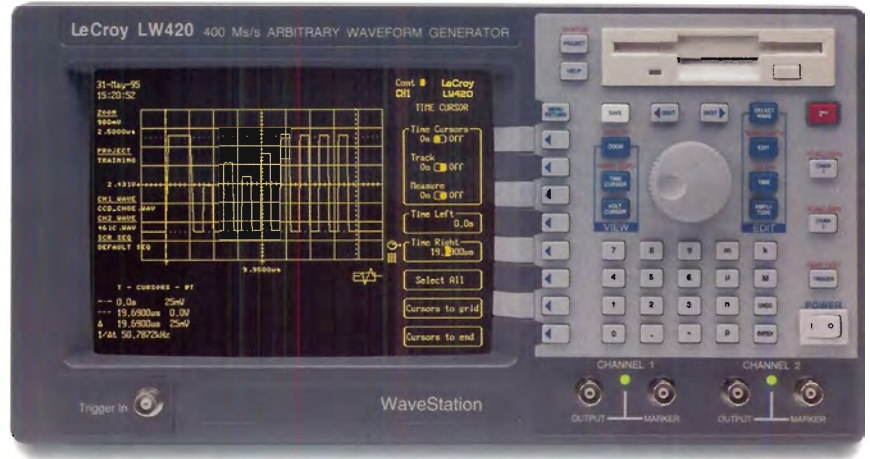

### Live Waveform Manipulation

Look at your waveform on the large screen of the LW420. Would you like to test the performance of your device against variations in signal timing or amplitude? Simply turn a knob and watch the effects of the signal change as it happens. Vary the widths of pulses, move their placement or change rise times smoothly and easily. In the past, AWGs were powerful tools, but slow to operate. Now you can do your job much faster.



### First AWG That's Easy To Use

Bring in your waveform from a LeCroy, Tek or HP digital scope with the touch of a button. Or import waveforms from PSPICE, MatLab or MathCad from a pull down menu. A large hard drive stores all your waveforms. Editing tools make it easy and fast to change the waveform, produce timing signals on the marker output or to produce digital patterns. If you are using an older AWG, the LeCroy LW420 will greatly improve your productivity.

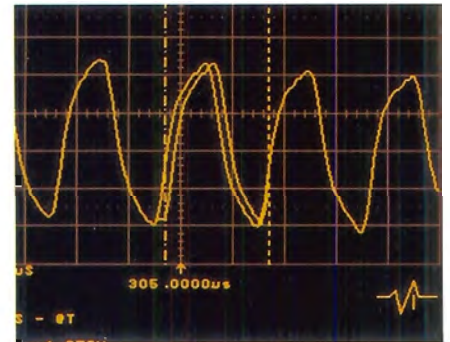

### 100 psec Resolution Feature Placement

Performing jitter tests has never been easier. Select a waveform feature by placing cursors around it. Then move the feature in finely controlled increments as small as 100 psec. You can move a single pulse, just a leading or trailing edge, or an entire packet of pulses. LeCroy's sub-sample waveform control gives high performance through superior technology.

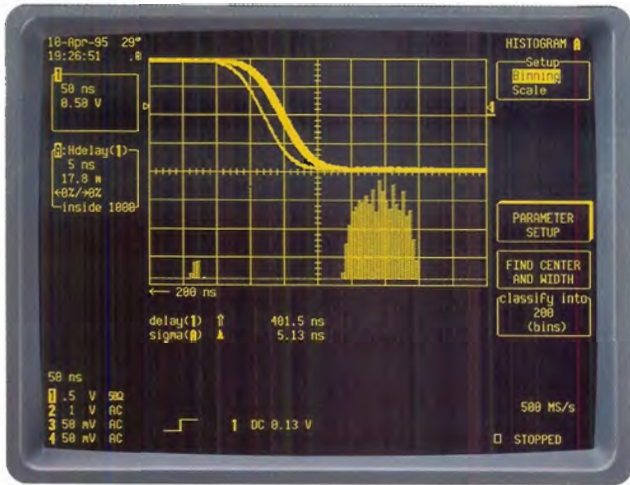

## Advanced Measurement

**50% More Viewing Space & 80% More Pixels**

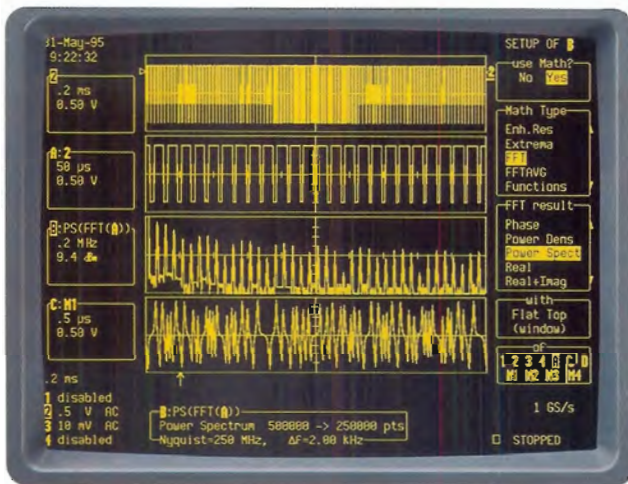

**Perform Transforms On Up To 6 Mbytes Of Data**

### 50% more viewing area

LeCroy scopes and AWG's have large 9" displays with 50% more area than the 7" displays used by other instrument manufacturers. On a LeCroy scope the waveform is never overwritten by text from menu selections or pulse parameters.

### Simultaneous Viewing Capability

On a LeCroy scope you can select single, dual or quad grids that automatically scale the data to acquire full eight bit resolution in each. Four simultaneous zoom displays with separate timebases and individual vertical expansions are available.

LeCroy offers an analysis package that will draw bar charts of over 40 pulse parameters and display them live on the screen.

### FFT Capability

One of the most popular options on DSO's is the Fast Fourier Transform. LeCroy scopes can perform transforms on up to 6 Mbytes of data. Many competitive scopes are limited to the first 10K acquired points. The difference in the frequency domain is 600 times better resolution from LeCroy.

### 80% More Pixels

Every scope user wants to see their signal with the best possible detail. LeCroy's high resolution screen with 810 x 696 pixels gives a more accurate view than the low resolution screens employed by other vendors.

### Histogramming

Do you want to look for instabilities in pulse widths, amplitudes or timing intervals? Would you like to monitor the stability of a signal or characterize the performance of a circuit under various conditions?



## Options

**Boost Your Productivity, Quality And Shorten Time-To-Market**



### Floppy Drive

DOS format 3.5" floppy supports either 720K or 1.44 Mbyte formats.



### DDM/PRML

Specialized test software for magnetic media measures PW50, TAA, Resolution, Overwrite, Autocorrelated Signal-to-Noise, Nonlinear Transition Shifts and other media characteristics.

### Graphics Printer

The internal graphics printer available for the 9300 series offers fast printouts. In less than 10 seconds you have a high resolution hard copy. The expanded form printout (up to 200X) offers exceptional detail to check signal shapes and timing.



### Hard Drive

PCMCIA portable hard drives are DOS format and can quickly store your raw data, FFT or other analysis, TIFF files for documents, front panel setups or Pass/Fail templates. The drive could also have your current engineering status report or ISO 9000 summary so that the data and document reside on the same drive.

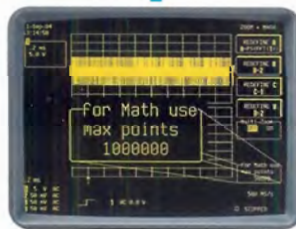

### Waveform Processor

LeCroy offers world class computing power with high speed processor/coprocessor and up to 64 Mbytes of RAM—whether you need a 100 MS/s or 10 GS/s scope.



### SRAM Memory Card

PCMCIA SRAM memory cards are the fastest way to store data or test setups. Sizes up to 4 Mbytes are available.



## Test & Measurement Products

### Digital Oscilloscopes

#### 9300 Series Portable Digital Oscilloscopes

9304A	4 Ch, 200 MHz, 100 MS/s, 50k Mem/Ch	15
9304AM	4 Ch, 200 MHz, 100 MS/s, 200k Mem/Ch	15
9310A	2 Ch, 400 MHz, 100 MS/s, 50k Mem/Ch	19
9310AM	2 Ch, 400 MHz, 100 MS/s, 200k Mem/Ch	19
9310AL	2 Ch, 400 MHz, 100 MS/s, 1 Meg Mem/Ch	19
9314A	4 Ch, 400 MHz, 100 MS/s, 50k Mem/Ch	19
9314AM	4 Ch, 400 MHz, 100 MS/s, 200k Mem/Ch	19
9314AL	4 Ch, 400 MHz, 100 MS/s, 1 Meg Mem/Ch	19
9320	2 Ch, 1 GHz, 20 GS/s (repetitive sampling)	23
9324	4 Ch, 1 GHz, 20 GS/s (repetitive sampling)	23
9350A	2 Ch, 500 MHz, 500 MS/s, 50k Mem/Ch	27
9350AM	2 Ch, 500 MHz, 500 MS/s, 250k Mem/Ch	27
9350AL	2 Ch, 500 MHz, 500 MS/s, 2 Meg Mem/Ch	27
9354A	4 Ch, 500 MHz, 500 MS/s, 50k Mem/Ch	27
9354AM	4 Ch, 500 MHz, 500 MS/s, 250k Mem/Ch	27
9354TM	4 Ch, 500 MHz, 500 MS/s, 500k Mem/Ch	27
9354AL	4 Ch, 500 MHz, 500 MS/s, 2 Meg Mem/Ch	27
9361	2 Ch, 300 MHz, 2.5 GS/s, 500 - 25k Mem/Ch	31
9362	2 Ch, 1.5 GHz, 10 GS/s, 500 - 25k Mem/Ch	31
9370	2 Ch, 1 GHz, 500 MS/s, 50k Mem/Ch	35
9370M	2 Ch, 1 GHz, 500 MS/s, 250k Mem/Ch	35
9370L	2 Ch, 1 GHz, 500 MS/s, 2 Meg Mem/Ch	35
9374	4 Ch, 1 GHz, 500 MS/s, 50k Mem/Ch	35
9374M	4 Ch, 1 GHz, 500 MS/s, 250k Mem/Ch	35
9374L	4 Ch, 1 GHz, 500 MS/s, 2 Meg Mem/Ch	35
OEM Kits	Oscilloscope Kits	39

#### Parameter Analysis Software

WP01	Waveform Processing Package	41
WP02	Spectrum Analysis Package	43
WP03	Parameter Analysis Package	47
DDM/PRML	Disk Drive Analysis Packages	49

#### 9300 Series Hardware Options

9300 Series I/O Hardware Options	53
Mega Waveform Processing	57
CKTRIG High Speed 500 MHz External Clock for the 9350A/9370 Series	59

#### 9300 Series Ordering Information

9300 Series Selection Guide	61
9300 Series Upgrade Information	66

#### ScopeStation LS140 Portable Digital Oscilloscope

ScopeStation LS140 - 4 Ch, 100 MHz, 200 MS/s	67
--	----

#### LS140 Ordering Information

	71
--	----



## Test & Measurement Products

### Probes & Accessories

Passive Probes	74
FET Probes	75
Differential Probes	76
Probe Power Supply	77
75Ω to 50Ω ProBus Adapter	77
Probe Kits	78
Instrument Carts	79
Instrument Cases	79
AP082/83 Trigger Pick-off for SDH/SONET	81

### Signal Sources

#### Introduction to Arbitrary Waveform Generators

LW410	400 MS/s	1 Channel	256k Memory/Ch	85
LW420	400 MS/s	2 Channel	256k Memory/Ch	85

#### Programmable Pulse Generators

9200 Series Pulse Generator	89	
9211 Module	250 MHz Variable Edges	93
9213 Module	50 MHz Variable Edges	94
9214 Module	300 MHz 300 psec Edges	95

#### Signal Source Ordering Information

97

### Technical Tutorials

Fundamentals of DSO's	99
Waveform Creation Made Easy	115

### Selected Applications

DSO Applications in High Speed Electronics	141
How to Use the Benefits of Long Memory in Digital Scopes	147
Finding Intermittent Faults in Electronic Signals	151
Making PRML Measurements with Digital Oscilloscopes	157
Benefits of DSOs in Communications	161
New Tools for Wireless Design	167
Testing 155 Mbps Signals	171
Benefits of Digital Oscilloscopes in Power Supply Design & Test	175

### Customer Service

Service & Warranty Information	179
Customer Feedback Form	181
Sales Offices	182
Terms & Conditions	184

### Glossary & Credits

Glossary	185
Credits	193



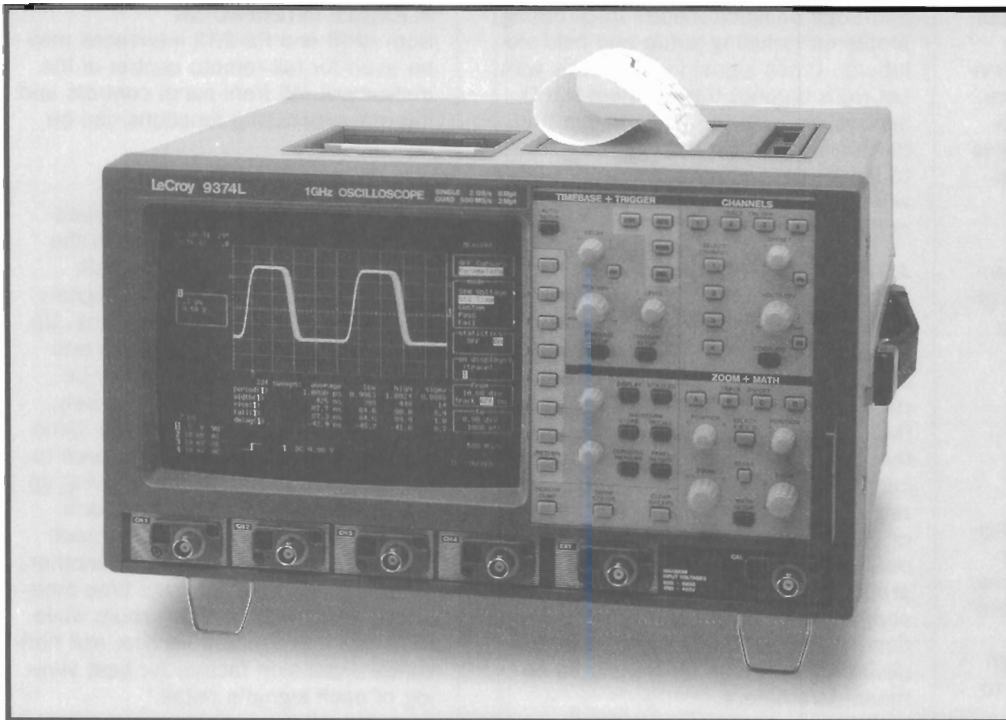

## Overview

Sampling rate, memory depth, and bandwidth. Choose the combination you need. The LeCroy 9300 family has it all! From the low cost quad 9304A to the high bandwidth 9374, the 9300 Series continues to expand with new configurations, all sharing an easy to use panel layout, programming command set, and memory card, floppy disk storage or PCMCIA portable hard drive. Recently we have added the award winning 9362 which at 10 GS/s is the World's Fastest DSO. The new 9370/74 series offers 1 GHz bandwidth and up to 2M of memory per channel for applications ranging from disk drive testing to communications design.

### THE EASIEST DSO TO USE

The 9300's knob-per function architecture is the easiest to use. You always know which knob to turn because their actions never change.

### CHOOSE THE MEMORY DEPTH YOU NEED

Available from 50k to 2M, deep memory avoids aliasing, making the DSO easier to believe. LeCroy's way of managing memory makes DSOs easier to use.

### FIND INTERMITTENT SIGNALS FAST WITHOUT COMPLEX TRIGGERING

Use LeCroy's 2 MByte memory and auto-trigger to capture as much data in 1 trigger as 4000 triggers that other scopes need in their 500 sample fast view mode. Or use

LeCroy's powerful Exclusion Trigger to look for anomalies. Either way, the resulting data can be saved to hard copy or into histograms that show irregular values for signal width, amplitude, timing and other characteristics. LeCroy gives you real measurements of signal anomalies. For more information refer to "Finding Intermittent Faults in Electronic Circuits (p. 149).

### A DISPLAY YOU CAN WATCH ALL DAY

All 9300 scopes have a large 9" display with super sharp 810 x 696 pixel resolution. Multi-zoom provides up to 4 simultaneous views of a waveform.

### MAKE THE MEASUREMENTS YOU WANT

Calculate any of 36 standard measurements on any part of the waveform. Calculate rise time or glitch energy. Pass/Fail tells if a waveform is out of spec. You can measure parameters between two traces such as propagation delays between two different signals. Built in processing converts waveforms to the most useful format. View power traces or frequency spectra - live!

### ADVANCED TRIGGER

Smart Trigger circuitry allows you to lock onto the most complex signal or hard-to-find glitch or dropout.

### STATISTICS

When measuring signal characteristics most users want to know the stability and worst case for risetime, propagation delay, etc. The statistics capability which is stan-

## 9300 Series Portable Oscilloscopes Cover the Widest Range of Applications

### Main Features

- Sampling Rates  
100 MS/s to  
10 GS/s
- Bandwidths  
200 MHz to 1.5 GHz
- Memory Lengths  
500 points to 8  
million points
- Large High  
Resolution Display
- Advanced Triggering
- Powerful Processing  
up to 64 MBytes of  
RAM
- I/O to floppy, PCM-  
CIA portable hard  
drive, SRAM card,  
GPIB, RS232 or  
Centronics.
- Internal High Speed  
Graphics Printer



standard in every 9300 extends the usefulness of the DSO. Observe average, minimum, maximum and standard deviation values for waveform parameters. The WPO3 option allows further parameter analysis by displaying bar charts showing histograms of parameter values.

#### A COMPLETE INSTRUMENT

In one mainframe, you can get 4 channels of DSO, floppy, memory card, high resolution graphics printer, spectrum analyzer, and signal processor.

### Features and Benefits

#### TIME MEASUREMENT MADE EASY AND ACCURATE

Common applications in fields like digital electronics, computers, data communications, etc., require precise time interval measurements. The long memories in the 9370/74, 9350A/54A, 9310A/14A and 9304A allow for high sampling rate over the whole signal to give excellent time resolution. The 9362 with its 10 GS/s real time sampling rate specializes in precise capture of fast events. Scope users who have repetitive signals will benefit from the 1 GHz bandwidth and two delayed timebases in the 9320/24 to capture signals at 20 GS/s equivalent time.

#### LECROY PROBUS INTELLIGENT PROBE SYSTEM

The ProBus system provides a complete measurement solution from probe tip to oscilloscope display. ProBus is an intelligent interconnection between LeCroy oscilloscopes and a growing range of innovative probes. ProBus provides automatic sensing of the probe type. For LeCroy's FET probes, it also allows offset at the probe tip and coupling to be controlled from the scope front panel.

#### A TRIGGER FOR EVERY APPLICATION

Two levels of trigger make catching difficult signals an easy task for the 9300 user. The standard trigger functions such as pre- and post-trigger, level, slope, mode and coupling are all accessed with simple and direct controls. The touch of a button accesses further powerful trigger features (SMART trigger). Icon trigger graphics show the current setup at a glance. SMART Trigger modes allow the acquisition of complex phenomena. Trigger techniques include Fastglitch mode for triggering on glitches down to 1 nsec. The ability to trigger on pulses greater than a particular length catches missing bits, timing shifts and runts. State

and Edge qualified modes track timing problems including setup and hold violations. Catch signal interruptions with LeCroy's dropout trigger. Most 9300 scopes also include video trigger and pattern trigger. If you don't know what to trigger on, LeCroy's Exclusion trigger will find events that differ from your nominal signal shape.

#### AUTOMATIC MEASUREMENTS

In addition to cursor measurements, the 9300 series performs fully automatic measurements. PASS/FAIL testing allows waveforms to be continually compared with a tolerance mask. (Masks may either be generated inside the instrument, or supplied on memory cards.) In addition, the scope can test any 5 waveform parameters from a list of 36, and compare them with user-defined limits. Any failure will cause preprogrammed actions such as Hardcopy, Save or GPIB SRQ. Basic statistics (low, high, average, and standard deviation) may also be calculated on these parameters.

#### DOS COMPATIBLE MASS STORAGE

The 9300 series offers three options (available together or separately) for built-in mass storage. Option 93XX-FD01 provides a 3.5" 1.44 MB floppy disk drive, option 93XX-HDD provides a PCMCIA portable hard drive. Both the floppy and hard drive store waveforms and setups as DOS files. They may be used as a convenient way of transferring data to a PC. Option MC01 provides high-speed storage to industry-standard memory cards, which are also DOS compatible. Up to 4 MB of data (waveforms or setups) may be stored on a single card. Portable hard drives have >130 MByte storage capacity.

Mass storage simplifies archiving, and can also be used to ensure that measurements are always made in the same way. Golden waveforms (or tolerance masks) may also be stored, so that signals are compared with a known reference. Waveform processing is possible on live or stored waveforms.

#### BUILT-IN PRINTER

As well as driving most printers and plotters via GPIB (IEEE-488.2), RS-232 and optional Centronics interfaces, the 9300 series also offers an optional internal printer. This high resolution graphics printer produces full size screen dumps in approximately 10 seconds. It also has a landscape printing mode which allows up to 200x expansion on the printout to see every detail of your signal.

#### FLEXIBLE INTERFACING

Both GPIB and RS-232 interfaces may be used for full remote control of the instrument. All front-panel controls and internal processing functions can be controlled.

#### MULTIPLE-WAVEFORM ZOOM

In addition to showing the complete waveform on the main timebase the 9300 series has four Zoom/Math traces which may be used for signal processing or zooming waveforms. Up to four traces (e.g., a waveform and three different expansions) may be viewed simultaneously. Alternatively, four different expansions of the same waveform may be viewed. The area to be expanded is selected by moving an intensified portion of the waveform. Cursor measurements may be made from one expanded portion to another, providing the most accurate time measurements possible. Each zoom waveform has independent vertical and horizontal expansion factors for best viewing of each signal's detail.

#### EXTENSIVE WAVEFORM MATH

Built-in processing includes mathematics (add, subtract, multiply and divide, negation,  $\sin/x$  and identity) and summation averaging (up to 1000 sweeps). Option WPO1 provides averaging (continuous and summed up to 1 million sweeps) and mathematics including Absolute Value, Differentiation, Identity, Integration, Log or Exp (Base e or Base 10), Negation, Reciprocal, Rescale, Square and Square Root. Also included is enhanced resolution mode (up to 11 bits) and extrema mode for storage of peak positive and negative values. More information is available in the 9300 WPO1 data sheet.

#### OPTIONAL FFT PACKAGE

Option WPO2 provides comprehensive spectral analysis capabilities. These permit the system designer to identify characteristics which may not be apparent in the time domain. Option WPO2 provides a wide selection of displayed projections (magnitude, phase, real, imaginary, power spectrum, power density) and windowing functions, as well as averaging in the frequency domain. For more information, see the 9300 WPO2 data sheet. LeCroy's FFT option is the most powerful in the industry. It provides superior resolution of frequency components through the ability to process up to 6 million time domain samples.



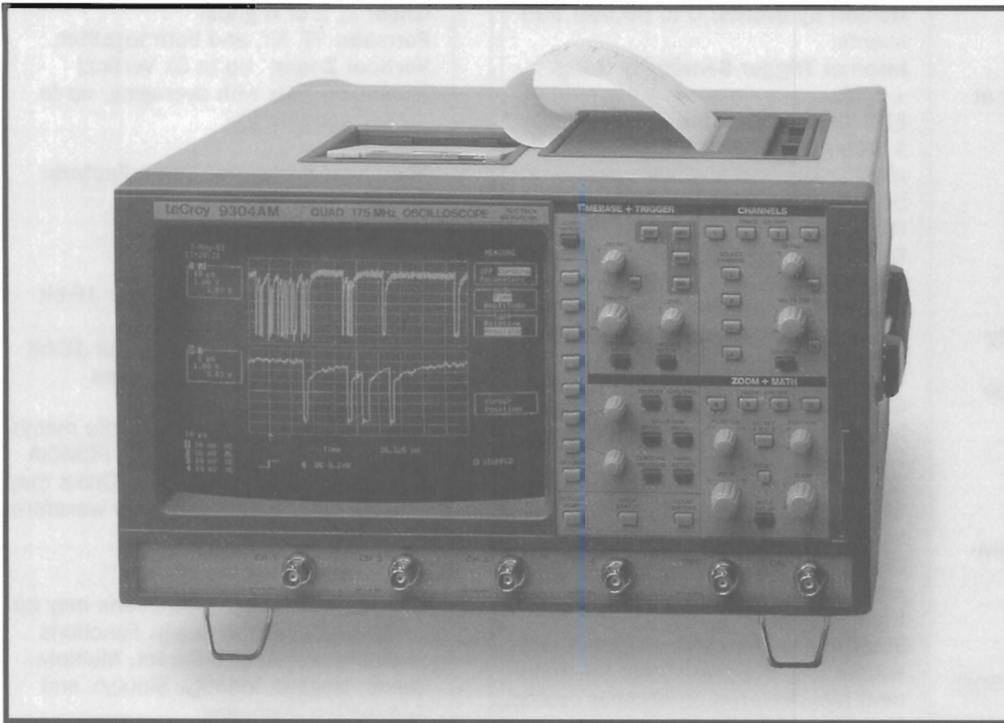

The 9304A and 9304AM are general purpose 200 MHz four channel digital oscilloscopes. They capture single-shot events at up to 100 MS/s, and repetitive signals at 10 GS/s. Record lengths up to 200k points provide excellent horizontal resolution, and allow fast digitizing of long-duration events. Memories can be segmented, for minimum dead time between acquisitions.

Live waveforms on the main timebase may be viewed simultaneously with up to 3 expansions, showing all of the signal detail. Expansions are shown as highlights on the main trace.

The LeCroy ProBus intelligent probe system allows automatic sensing of the probe type. For LeCroy's active FET probes it also provides variable offset at the probe tip. Offset and coupling are controlled from the scope's front panel.

SMART Trigger modes like Glitch, Window and Dropout allow you to capture precisely the events of interest.

A comprehensive range of signal processing functions, on live or stored waveforms, allows waveform manipulation without destroying the underlying data.

The 9304A and 9304AM feature the proven user-interface of LeCroy's portable scope family. A bright, high-resolution 9" CRT allows optimum waveform viewing on a high resolution 810 x 696 pixel screen under any conditions. Menus and text are arranged around the graticules - they never overwrite the waveforms. Each of the main control functions has a dedicated single knob, to keep the scope's performance at your fingertips.

DOS compatible floppy disk, PCMCIA portable hard drive and memory card options store waveforms and test setups, and make transferring data to a PC easier than ever. Hardcopies can be made on GPIB, RS-232-C or Centronics printers or plotters. An optional internal high resolution graphics printer is also available.

Optional packages provide extensive Waveform Processing including FFT and Enhanced Resolution to 11 bits.

## 9304A, 9304AM Digital Oscilloscopes 200 MHz Bandwidth, 100 MS/s

### Main Features

- Four Channels
- 50k and 200k Point Records
- DOS Compatible Floppy Disk, PCMCIA portable hard drive and Memory Card Options
- Glitch, Window, Qualified, Interval, Dropout and Video Triggers
- 8-bit vertical resolution, 11 with ERES option
- Fully Programmable via GPIB and RS-232-C
- Automatic PASS/FAIL testing
- Persistence, XY and Roll Modes
- Advanced Signal Processing
- Internal High Resolution Graphics Printer Option



**ACQUISITION SYSTEM****Bandwidth (-3 dB)**

@ 50Ω: DC to 200 MHz  
@ 1 MΩ DC: DC to 200 MHz typical at the probe tip.

**No. of Channels:** 4

**No. of Digitizers:** 4

**Maximum Sample Rate:** 100 MS/s simultaneously on each channel.

Acquisition memories, per channel:  
9304A 50k  
9304AM 200k

**Sensitivity:** 2 mV/div to 5 V/div, fully variable.

**Scale factors:** A wide choice of probe attenuation factors are selectable.

**Offset Range:**

2.0 - 9.9 mV/div: ± 120 mV  
10 - 199 mV/div: ± 1.2 V  
0.2 - 5.0 V/div: ± 24 V

**DC Accuracy:** ≤ ± 2% full scale (8 divisions) at 0 V offset.

**Vertical Resolution:** 8 bits.

**Bandwidth Limiter:** 30 MHz.

**Input Coupling:** AC, DC, GND.

**Input Impedance:** 1 MΩ//15 pF or 50Ω ± 1%.

**Max Input:**

1 MΩ: 250 V (DC+peak AC@ 10 kHz)  
50 Ω: ± 5 V DC (500 mW) or  
5 V RMS

**TIME BASE SYSTEM**

**Timebases:** Main and up to 4 Zoom Traces.

**Time/Div Range:** 1 ns/div to 1000 s/div.

**Clock Accuracy:** ≤ ± 0.002 %.

**Interpolator Resolution:** 10 ps.

**Roll Mode:** Ranges 500 ms to 1,000 s/div.

**For > 50k points:** 10 s to 1,000 s/div.

**External Clock:** ≤ 100 MHz on EXT input with ECL, TTL or zero crossing levels.

**TRIGGERING SYSTEM**

**Trigger Modes:** Normal, Auto, Single, Stop.

**Trigger Sources:** CH1, CH2, CH3, CH4, Line, Ext, Ext/10. Slope, Level and Coupling for each can be set independently.

**Slope:** Positive, Negative, Window (BiSlope).

**Coupling:** AC, DC, HF (up to 500 MHz), LFREJ, HFREJ.

**Pre-trigger recording:** 0 to 100% of full scale (adjustable in 1% div increments).

**Post-trigger delay:** 0 to 10,000 divisions (adjustable in 0.1 div increments).

**Holdoff by time:** 10 ns to 20 s.

**Holdoff by events:** 0 to 99,999,999 events.

**Internal Trigger Sensitivity Range:** ± 5 div.

**EXT Trigger Max. Input:**

1 MΩ//15 pF: 250 V (DC+peak AC ≤ 10 kHz)  
50Ω ± 1%: ± 5 V DC (500 mW) or 5 V RMS

**EXT Trigger Range:** ±0.5V (±5V with Ext/10).

**Trigger Timing:** Trigger Date and Time are listed in the Memory Status Menu.

**SMART TRIGGER TYPES**

**Signal Width:** Trigger on width between two limits selectable from 2.5ns to 20s.

**Signal Interval:** Trigger on interval between two limits selectable from 10ns to 20s.

**Dropout:** Trigger if the input signal drops out for longer than a time-out from 25ns to 20s.

**State/Edge Qualified:** Trigger on any source only if a given state (or transition) has occurred on another source. The delay between these events can be defined as a number of events on the trigger channel or as a time interval.

**TV:** Allows selection of both line (up to 1500) and field number (up to 8) for PAL, SECAM, NTSC or non-standard video.

**ACQUISITION MODES**

**Random Interleaved Sampling (RIS):** for repetitive signals from 1 ns/div to 5 ms/div.

**Single shot:** for transient and repetitive signals from 50 ns/div.

**Sequence:** Stores multiple events in segmented acquisition memories.

Number of segments available:

9304A 2-200  
9304AM 2-500

**Dead Time between segments:** ≤150 ms

**DISPLAY**

**Waveform style:** Vectors connect the individual sample points, which are highlighted as dots. Vectors may be switched off.

**CRT:** 12.5 x 17.5 cm (9" diagonal) raster.

**Resolution:** 810 x 696 points.

**Modes:** Normal, X-Y, Variable or Infinite Persistence.

**Real-time Clock:** Date, hours, minutes, seconds.

**Graticules:** Internally generated; separate intensity control for grids and waveforms.

**Grids:** 1, 2 or 4 grids.

**Formats:** YT, XY, and both together.

**Vertical Zoom:** Up to 5x Vertical Expansion (50x with averaging, up to 40 mV sensitivity).

**Maximum Horizontal Zoom Factors:**

9304A 1,000x  
9304AM 5,000x

**INTERNAL MEMORY**

**Waveform Memory:** Up to four 16-bit Memories (M1, M2, M3, M4).

**Processing Memory:** Up to four 16-bit Waveform Processing Memories (A,B,C,D).

**Setup Memory:** Four non-volatile memories. Optional Memory Cards, PCMCIA portable hard drive or Floppy Disks may also be used for high-capacity waveform and setup storage.

**WAVEFORM PROCESSING**

Up to four processing functions may be performed simultaneously. Functions available are: Add, Subtract, Multiply, Divide, Negate, Identity, Sin(x)/x and Summation Averaging.

**Average:** Summed averaging of up to 1,000 waveforms in the basic instrument. Up to 10<sup>6</sup> averages are possible with Option WP01.

**Envelope\*:** Max, Min, or Max and Min values of from 1 to 10<sup>6</sup> waveforms.

**ERES\*:** Low-Pass digital filter provides up to 11 bits vertical resolution. Sampled data is always available, even when trace is turned off. Any of the above modes can be invoked without destroying the data.

**FFT\*:** Spectral Analysis with four windowing functions and FFT averaging.

\* Envelope and ERES modes are provided in Math Package WP01, FFT is in WP02.

**AUTOMATIC MEASUREMENTS**

The following Parametric measurements are available, together with statistics of their Average, Highest, Lowest values and Standard Deviation:

amplitude	Δt at level (t=0,abs)	overshoot +
area	Δt at level (t=0%)	overshoot -
base	duty cycle	peak to peak
cmean	falltime	period
cmedian	f80-20%	risetime
crms	f@level (abs)	r20-80%
csdev	f@level (%)	r@level (abs)
cycles	frequency	r@level (%)
delay	maximum	RMS
Δdelay	mean	std dev
Δt at level (abs)	median	top
Δt at level (%)	minimum	width

Parameters are calculated as defined by ANSI/IEEE Std 181-1977 "Standard on Pulse Measurement and Analysis by Objective Techniques". In addition, Rise and Fall times may be measured at 10 % and 90% levels, or 20% and 80% levels, or any other user-specified levels.

**Δdelay** provides time between mid-point transition of two sources, for making propagation delay measurements.

**Δt at level** allows the same measurement to be made at any specified level.

Two cursors are used to define the region over which these parameters are calculated.

**Relative Time:** Two cursors provide time measurements with resolution of  $\pm 0.05\%$  full scale for unexpanded traces; up to 10 % of the sampling interval for expanded traces. The corresponding frequency value is also displayed.

**Relative Voltage:** Two horizontal bars measure voltage differences up to  $\pm 0.2\%$  of fullscale in single-grid mode.

**Absolute Time:** A cross hair marker measures time relative to the trigger, and voltage with respect to ground.

**Pass/Fail** testing allow up to five of the listed parameters to be tested against selectable thresholds. Waveform Limit Testing is performed using templates which may be defined inside the instrument.

#### AUTOSETUP

Pressing Autosetup sets timebase, trigger and sensitivity to display a wide range of repetitive signals. (Amplitude 2mV to 40V; frequency above 50Hz; Duty cycle greater than 0.1%).

**Autosetup Time:** Approximately 2 seconds.

**Vertical Find:** Automatically sets sensitivity and offset.

#### PROBES

##### Model:

One PP002 (10:1, 10 M $\Omega$  // 15 pF) probe supplied per channel. The 9304A and 9304AM are fully compatible with LeCroy's range of FET Probes, which may be purchased separately.

**Probe calibration:** Max 1 V into 1 M $\Omega$ , 500 mV into 50 $\Omega$ , frequency and amplitude programmable, pulse or

square wave selectable, rise and fall time 1 ns typical. Alternatively, the Calibrator output can provide a trigger output or a PASS/FAIL test output.

#### INTERFACING

**Remote Control:** Of all front-panel controls, as well as all internal functions is possible by GPIB and RS-232-C.

**RS-232-C Port:** Asynchronous up to 19,200 baud for computer/terminal control or printer/plotter connection.

**GPIB Port:** (IEEE-488.1) Configurable as talker/listener for computer control and fast data transfer.

Command Language complies with requirements of IEEE-488.2.

**Centronics Port:** Optional hardcopy parallel interface included with floppy disk and graphics printer options.

**Hardcopy:** Screen dumps are activated by a front-panel button or via remote control. TIFF and BMP formats are available for importing to Desktop Publishing programs. The following printers and plotters can be used to make hardcopies: HP DeskJet (color or B&W), HP ThinkJet, QuietJet, LaserJet, PaintJet and EPSON printers. HP 7400 and 7500 series, or HPGL compatible plotters. An optional internal high resolution graphics printer is also available, see page 53.

#### GENERAL

Auto-calibration ensures specified DC and timing accuracy.

##### Temperature:

5° to 40° C (41° to 104° F) rated. 0° to 50° C (32° to 122° F) operating.

**Humidity:** < 80%.

##### Shock & Vibration:

Meets MIL-STD-810C modified to LeCroy design specifications and MIL-T-28800C.

**Power:** 90-250 V AC, 45-66 Hz, 150 W.

**Battery Backup:** Front-panel settings maintained for two years.

##### Dimensions: (HWD)

8.5"x14.5"x16.25", 210mm x 370mm x 410mm.

**Weight:** 12.5kg (27.5lbs) net, 18kg (40lbs) shipping.

**Warranty:** Three years.



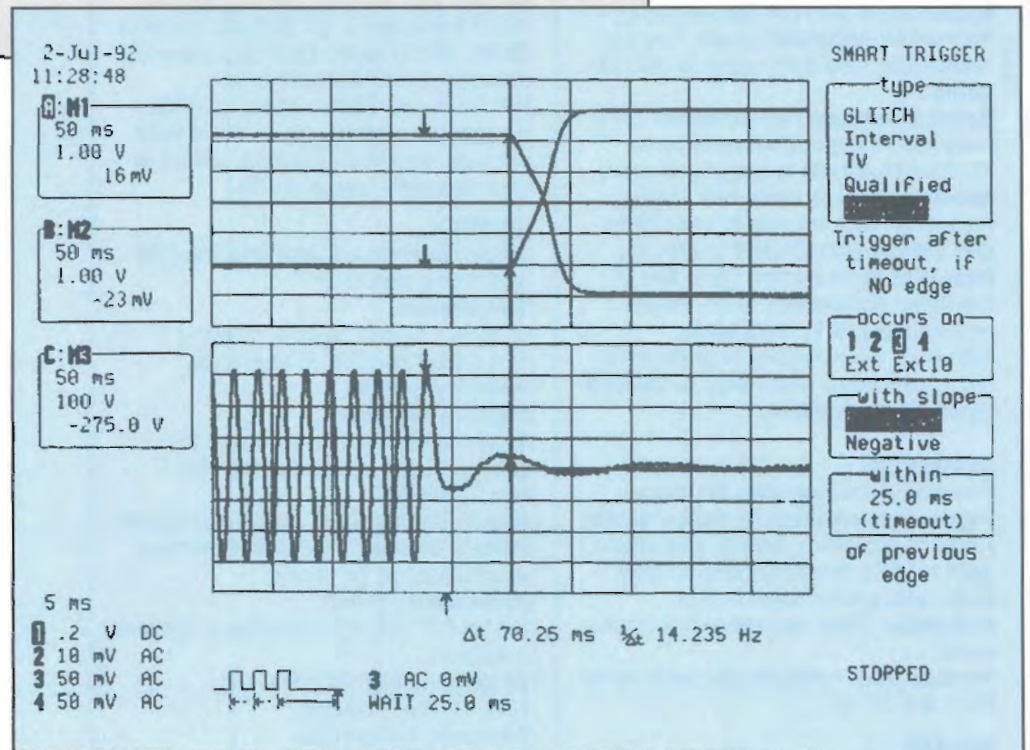
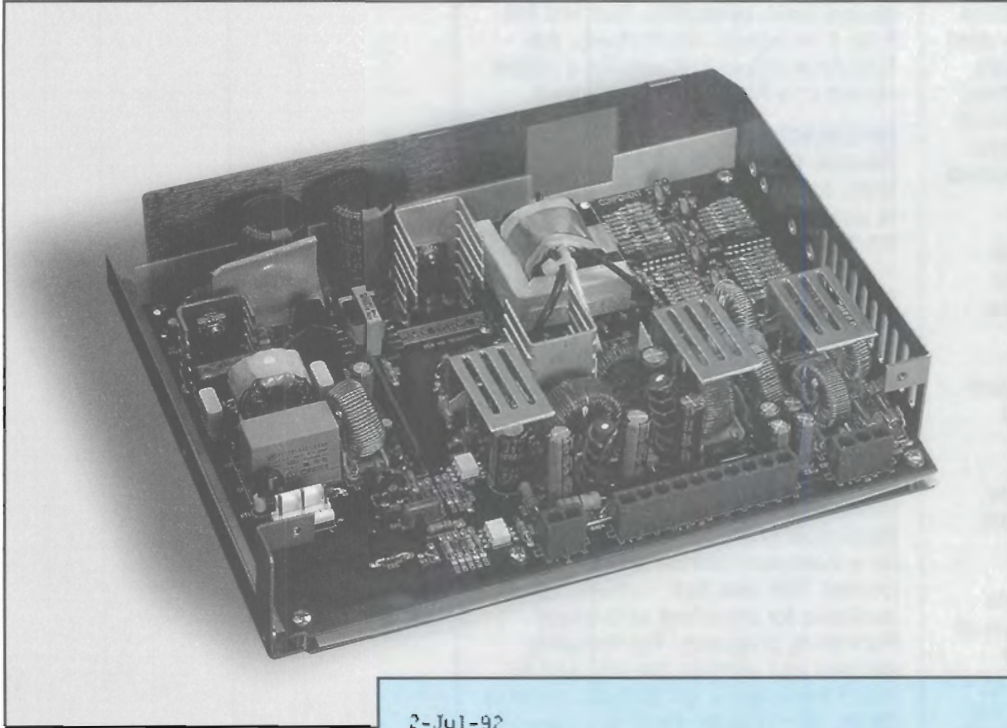

Testing holdup time on a DC power supply is easy using LeCroy's dropout trigger. For more information on power supply testing, refer to the application note on page 175 of this catalog.



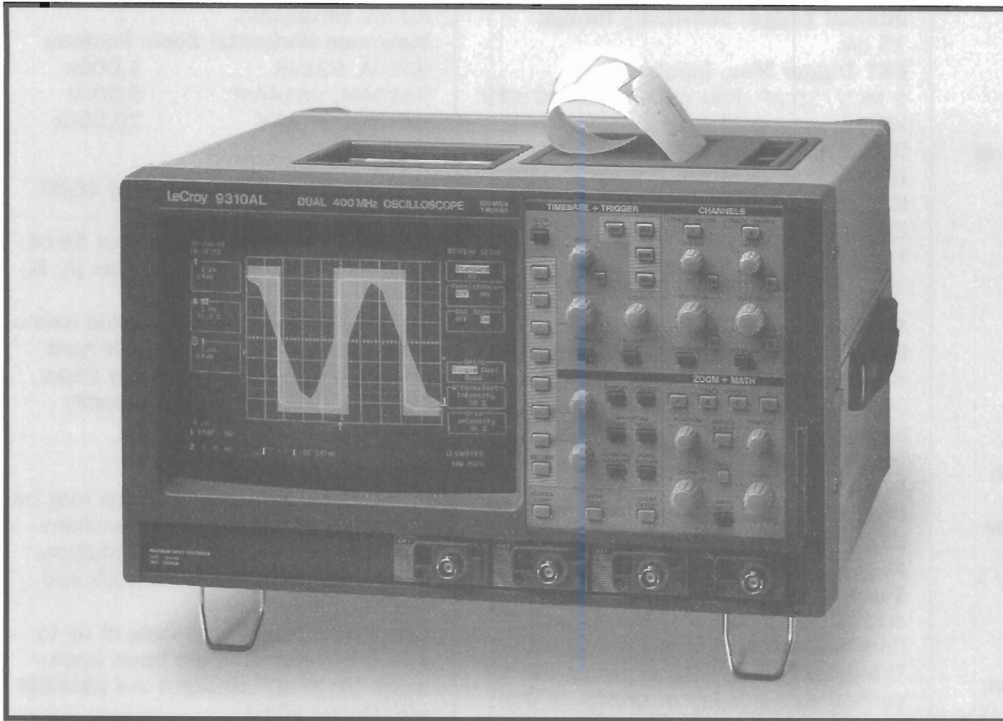

The 9310A family offers two channel and four channel general-purpose 400 MHz digital oscilloscopes. They capture single-shot events at up to 100 MS/s, and repetitive signals at 10 GS/s. Record lengths up to 1M points provide outstanding horizontal resolution, and allow fast digitizing of long-duration events. Memories can be segmented, for minimum dead time between acquisitions.

Live waveforms on the main timebase may be viewed simultaneously with up to 3 expansions, showing all of the signal detail. Expansions are shown as highlights on the main trace.

The LeCroy ProBus intelligent probe system allows automatic sensing of the probe type. For LeCroy's active FET probes it also provides variable offset at the probe tip. Offset and coupling are controlled from the scope front panel.

SMART Trigger modes like Glitch, Window and Dropout allow you to capture precisely the events of interest.

A comprehensive range of signal processing functions, on live or stored waveforms, allows waveform manipulation without destroying the underlying data.

The 9310A family features the proven user-interface of LeCroy's portable scope family. A bright 9" CRT allows optimum waveform viewing on a high resolution 810 x 696 pixel screen. Menus and text are arranged around the graticules - they never overwrite the waveforms. Each of the main control functions has a dedicated single knob, to keep the scope's performance at your fingertips.

DOS compatible floppy disk, PCMCIA portable hard drive and memory card options store waveforms and test setups, and make transferring data to a PC easier than ever before. Hardcopies can be made on GPIB, RS-232-C or Centronics printers or plotters. An optional internal high resolution graphics printer is also available.

Optional packages provide extensive Waveform Processing including FFT and Enhanced Resolution to 11 bits.

## 9310A Family Digital Oscilloscopes 400 MHz Bandwidth, 100 MS/s

### Main Features

- Two and Four Channel Versions
- 50k, 200k and 1M Point Records
- DOS Compatible Floppy Disk, PCMCIA portable hard drive and Memory Card Options
- Glitch, Window, Qualified, Interval, Dropout and TV Triggers
- 8-bit vertical resolution, 11 with ERES option
- Fully Programmable via GPIB and RS-232-C
- Automatic PASS/FAIL testing
- Persistence, XY and Roll Modes
- Advanced Signal Processing
- Internal High Resolution Graphics Printer Option

**ACQUISITION SYSTEM****Bandwidth (-3 dB)**

@ 50Ω: DC to 400 MHz  
Below 200 mV/div: 350 MHz  
At 2mV/div: 300 MHz  
@ 1 MΩ DC: DC to 250 MHz typical at the probe tip.

**No. of Channels:** 4 (9314A) or 2 (9310A)

**No. of Digitizers:** 4 (9314A) or 2 (9310A)

**Maximum Sample Rate:** 100 MS/s simultaneously on each channel.

Acquisition memories, per channel:  
9310A, 9314A 50k  
9310AM, 9314AM 200k  
9310AL, 9314AL 1M

**Sensitivity:** 2 mV/div to 5 V/div, fully variable.

**Scale factors:** A wide choice of probe attenuation factors are selectable.

**Offset Range:**

2.0 - 9.9 mV/div: ± 120 mV  
10 - 199 mV/div: ± 1.2 V  
0.2 - 5.0 V/div: ± 24 V

**DC Accuracy:** ≤± 2% full scale (8 divisions) at 0 V offset.

**Vertical Resolution:** 8 bits.

**Bandwidth Limiter:** 30 MHz.

**Input Coupling:** AC, DC, GND.

**Max Input:**

1 MΩ: 250 V (DC+peak AC@ 10 kHz)  
50Ω: ± 5 V DC (500 mW) or 5 V RMS

**TIME BASE SYSTEM**

**Timebases:** Main and up to 4 Zoom Traces.

**Time/Div Range:** 1 ns/div to 1000 s/div.

**Clock Accuracy:** ≤±0.002 %.

**Interpolator Resolution:** 10 ps.

**Roll Mode:** Ranges 500 ms to 1,000 s/div.

For > 50k points: 10 s to 1,000 s/div.

**External Clock:** ≤100 MHz on EXT input with ECL, TTL or zero crossing levels.

**TRIGGERING SYSTEM**

**Trigger Modes:** Normal, Auto, Single, Stop.

**Trigger Sources:** CH1, CH2, Line, Ext, Ext/10 (9314A: CH3, CH4). Slope, Level and Coupling for each can be set independently.

**Slope:** Positive, Negative, Window (BiSlope).

**Coupling:** AC, DC, HF (up to 500 MHz), LFREJ, HFREJ.

**Pre-trigger recording:** 0 to 100% of full scale (adjustable in 1% div increments).

**Post-trigger delay:** 0 to 10,000 divisions (adjustable in 0.1 div increments).

**Holdoff by time:** 10 ns to 20 s.

**Holdoff by events:** 0 to 99,999,999 events.

**Internal Trigger Sensitivity Range:**

±5 div.

**EXT Trigger Max. Input:**

1 MΩ/15 pF: 250 V (DC+peak AC ≤10 KHz)

50Ω ± 1%: ±5 V DC (500 mW) or 5 V RMS

**EXT Trigger Range:** ±0.5V (±5V with Ext/10).

**Trigger Timing:** Trigger Date and Time are listed in the Memory Status Menu.

**SMART TRIGGER TYPES**

**Signal Width:** Trigger on width between two limits selectable from 2.5ns to 20s.

**Signal Interval:** Trigger on interval between two limits selectable from 10ns to 20s.

**Dropout:** Trigger if the input signal drops out for longer than a time-out from 25ns to 20s.

**State/Edge Qualified:** Trigger on any source only if a given state (or transition) has occurred on another source. The delay between these events can be defined as a number of events on the trigger channel or as a time interval.

**TV:** Allows selection of both line (up to 1500) and field number (up to 8) for PAL, SECAM, NTSC or non-standard video.

**ACQUISITION MODES**

**Random Interleaved Sampling (RIS):** for repetitive signals from 1 ns/div to 10 ms/div.

**Single shot:** For transient and repetitive signals from 50 ns/div.

**Sequence:** Stores multiple events in segmented acquisition memories. Number of segments available:

9310A-9314A	2-200
9310AM-9314AM	2-500
9310AL-9314AL	2-2,000

**Dead Time between segments:** ≤150 μs

**DISPLAY**

**Waveform style:** Vectors connect the individual sample points, which are highlighted as dots. Vectors may be switched off.

**CRT:** 12.5 x 17.5 cm (9" diagonal) raster.

**Resolution:** 810 x 696 points.

**Modes:** Normal, X-Y, Variable or Infinite Persistence.

**Real-time Clock:** Date, hours, minutes, seconds.

**Graticules:** Internally generated; separate intensity control for grids and waveforms.

**Grids:** 1, 2 or 4 grids.

**Formats:** YT, XY, and both together.

**Vertical Zoom:** Up to 5x Vertical Expansion (50x with averaging, up to

40 mV sensitivity).

**Maximum Horizontal Zoom Factors:**

9310A, 9314A	1,000x
9310AM, 9314AM	5,000x
9310AL, 9314AL	20,000x

**INTERNAL MEMORY**

**Waveform Memory:** Up to four 16-bit Memories (M1, M2, M3, M4).

**Processing Memory:** Up to four 16-bit Waveform Processing Memories (A, B, C, D).

**Setup Memory:** Four non-volatile memories. Optional PCMCIA portable hard drive, Memory Cards or Floppy Disks may also be used for high-capacity waveform and setup storage.

**WAVEFORM PROCESSING**

Up to four processing functions may be performed simultaneously. Functions available are: Add, Subtract, Multiply, Divide, Negate, Identity, Sin(x)/x and Summation Averaging.

**Average:** Summed averaging of up to 1,000 waveforms in the basic instrument. Up to 10<sup>6</sup> averages are possible with Option WP01.

**Envelope\*:** Max, Min, or Max and Min values of from 1 to 10<sup>6</sup> waveforms.

**ERES\*:** Low-Pass digital filter provides up to 11 bits vertical resolution. Sampled data is always available, even when trace is turned off. Any of the above modes can be invoked without destroying the data.

**FFT\*:** Spectral Analysis with four windowing functions and FFT averaging.

\*Envelope and ERES modes are provided in Math Package WP01. FFT is in WP02.

**AUTOMATIC MEASUREMENTS**

The following Parametric measurements are available, together with statistics of their Average, Highest, Lowest values and Standard Deviation:

amplitude	Δt at level (t=0,abs)	overshoot +
area	Δt at level (t=0%)	overshoot -
base	duty cycle	peak to peak
cmean	falltime	period
cmedian	f80-20%	risetime
crms	f@level (abs)	r20-80%
csdev	f@level (%)	r@level (abs)
cycles	frequency	r@level (%)
delay	maximum	RMS
Δdelay	mean	std dev
Δt at level (abs)	median	top
Δt at level (%)	minimum	width

Parameters are calculated as defined by ANSI/IEEE Std 181-1977 "Standard on Pulse Measurement and Analysis by Objective Techniques". In addition, Rise and Fall times may be measured at 10



% and 90% levels, or 20% and 80% levels, or any other user-specified levels.

$\Delta$ delay provides time between mid-point transition of two sources, for making propagation delay measurements.

$\Delta$ t at level allows the same measurement to be made at any specified level.

Two cursors are used to define the region over which these parameters are calculated.

**Relative Time:** Two cursors provide time measurements with resolution of  $\pm 0.05\%$  full scale for unexpanded traces; up to 10 % of the sampling interval for expanded traces. The corresponding frequency value is also displayed.

**Relative Voltage:** Two horizontal bars measure voltage differences up to  $\pm 0.2\%$  of fullscale in single-grid mode.

**Absolute Time:** A cross hair marker measures time relative to the trigger, and voltage with respect to ground.

**Pass/Fail** testing allow up to five of the listed parameters to be tested against selectable thresholds. Waveform Limit Testing is performed using templates which may be defined inside the instrument.

#### AUTOSETUP

Pressing Autosetup sets timebase, trigger and sensitivity to display a wide range of repetitive signals. (Amplitude 2mV to 40V; frequency above 50Hz; Duty cycle greater than 0.1%).

**Autosetup Time:** Approximately 2 seconds.

**Vertical Find:** Automatically sets sensitivity and offset.

#### PROBES

**Model:** One PP002 (10:1, 10 M $\Omega$  // 15 pF) probe supplied per channel. The 9310A family is fully compatible with LeCroy's range of FET Probes, which may be purchased separately.

**Probe calibration:** Max 1 V into 1 M $\Omega$ , 500 mV into 50 $\Omega$ , frequency and amplitude programmable, pulse or square wave selectable, rise and fall time 1 ns typical.

Alternatively, the Calibrator output can provide a trigger output or a PASS/FAIL test output.

#### INTERFACING

**Remote Control:** Of all front-panel controls, as well as all internal functions is possible by GPIB and RS-232-C.

**RS-232-C Port:** Asynchronous up to 19,200 baud for computer/terminal control or printer/plotter connection.

**GPIB Port:** (IEEE-488.1) Configurable as talker/listener for computer control and fast data transfer. Command Language complies with requirements of IEEE-488.2.

**Centronics Port:** Optional hardcopy parallel interface included with floppy disk and graphics printer options.

**Hardcopy:** Screen dumps are activated by a front-panel button or via remote control. TIFF and BMP formats are available for importing to Desktop Publishing programs. The following printers and plotters can be used to make hardcopies: HP DeskJet (color or B&W), HP ThinkJet, QuietJet, LaserJet, PaintJet and EPSON printers. HP 7400 and 7500 series, or HPGL compatible plotters. An optional internal high resolution graphics printer is also available, see page 53.

#### GENERAL

Auto-calibration ensures specified DC and timing accuracy.

**Temperature:** 5° to 40° C (41° to 104° F) rated, 0° to 50° C (32° to 122° F) operating.

**Humidity:** <80%.

#### Shock & Vibration:

Meets MIL-STD-810C modified to LeCroy design specifications and MIL-T-28800C.

**Power:** 90-250 V AC, 45-66 Hz, 150W.

**Battery Backup:** Front-panel settings maintained for two years.

**Dimensions:** (HWD)  
8.5"x14.5"x16.25", 210mm x 370mm x 410mm.

**Weight:** 12.5kg (27.5lbs) net, 18kg (40lbs) shipping.

**Warranty:** Three years.

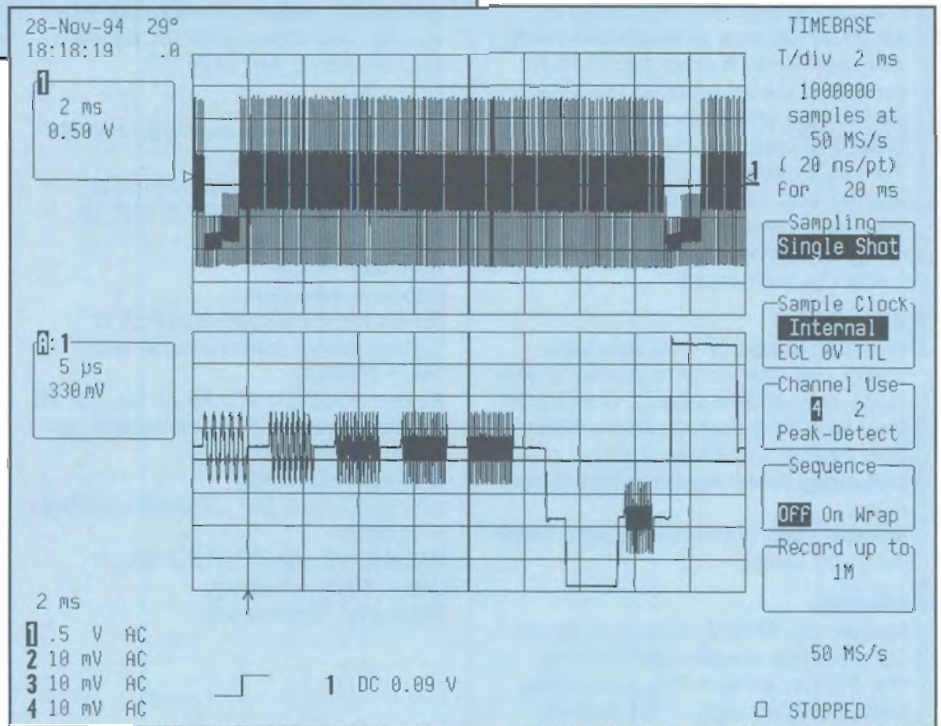
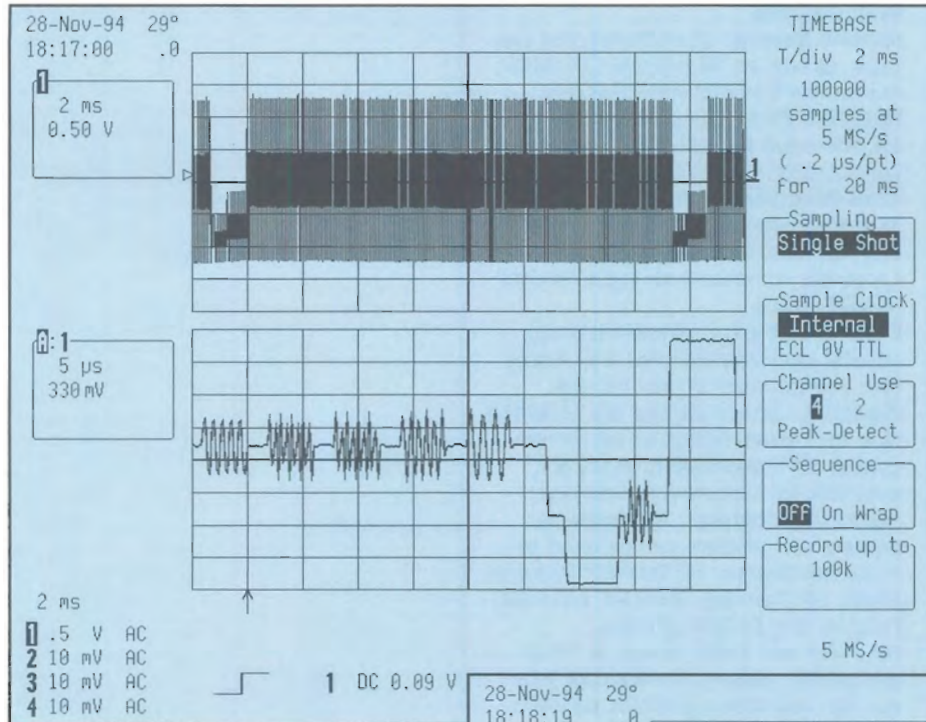

Long Memory allows a scope to capture long duration signals at a high sample rate. Note the difference in detail in the zoom sections shown on the lower traces of the two scope screens above. A 1 megapoint scope puts 20 times more points on the waveform than a 50k point scope. For further discussion refer to "How to use the Benefits of Long Memory in DSOs" on Page 147 of this catalog.



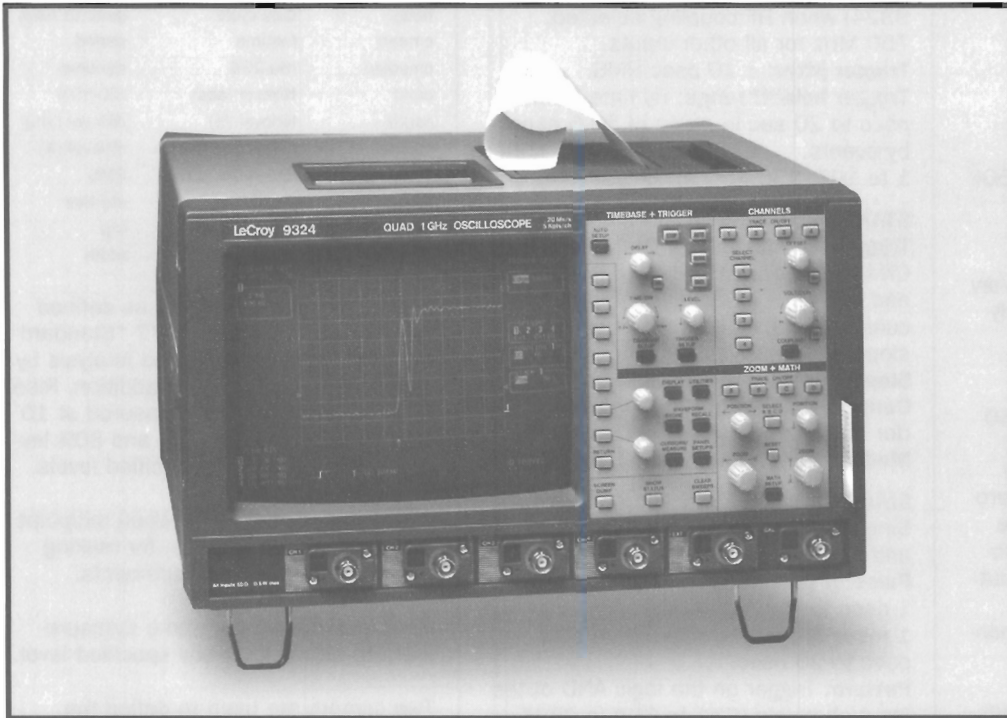

The 9320/24 are two and four channel instruments extending the power of digital oscilloscopes up to 1 GHz bandwidth. The oscilloscope is primarily intended for repetitive waveforms, which are sampled with an equivalent sampling rate of up to 20 GS/sec. Single shot events up to a few MHz may also be acquired with a single shot sampling rate of up to 20 MS/sec.

The digital technology used provides standard DSO features like pre-trigger view, hardcopy, full programmability, etc. The proven user interface of the 9300 oscilloscope family ensures ease of use and user efficiency.

The LeCroy ProBus intelligent probe system allows automatic sensing of the probe type. For LeCroy's active FET probes it also provides variable offset at the probe tip. Offset and coupling are controlled from the scope front panel.

Up to two delayed timebases can be positioned on the main trace and displayed giving excellent resolution and precision in time measurements.

Advanced triggering capabilities, which include glitch, pattern and state/edge qualified triggers simplify the testing and debugging of electronics systems.

DOS compatible floppy disk, PCMCIA portable hard drive and memory card options store waveforms and test setups, and make transferring data to a PC easier than ever before. Hardcopies may be made on GPIB, RS-232 or Centronics printers or plotters. An optional built-in high resolution graphics printer is also available. Additional firmware packages extend the oscilloscope's processing capabilities in both time and frequency domains.

Analog oscilloscope users who have been using 350 - 400 MHz scopes to look at signals will find the higher bandwidth and digital measurement power of the 9320/24 gives them outstanding performance at a comparable price.

Communications engineers who require 1 GHz bandwidth scopes to look at 155 Mbps data will find the combination of the 9320/24 and AP082/83 trigger pickoffs very powerful for testing SDH and SONET signals. Refer to Page 171 for more information.

## 9320 and 9324, 1GHz Bandwidth Portable Digital Oscilloscopes

### Main Features

- 1 GHz Bandwidth
- Two or Four Channels
- Main and two delayed timebases for accurate time measurements
- Glitch, pattern, state and edge qualified triggers
- Automatic pass/fail testing
- Optional built-in high resolution graphics printer
- DOS-compatible floppy disk, PCMCIA portable hard drive and memory card options
- Fully programmable via GPIB and RS-232

**ACQUISITION SYSTEM**

**No. of channels:** 2 (9320) and 4 (9324).

**Bandwidth (-3 dB):** DC to 1 GHz.

**Rise time:** < 350 psec.

**Input impedance:** 50Ω ±1%.

**Maximum input voltage:** ±5 V DC (500 mW) or 5 V RMS.

**Maximum Input Voltage:** ± 5 V DC (500mW) or 5 V RMS.

**Sensitivity range:** 5 mV/div to 2 V/div in 1, 2, 5 sequence and continuously variable.

**Random noise:** < 500 μV RMS at 5 mV/div.

**Probe calibrator:** BNC connector, 250 mV into 50Ω, generates rectangular pulses with 50% duty cycle; rise/fall times < 500 psec; flatness < 1%; zero offset; programmable frequency. The calibrator output can alternatively provide, under menu control, a trigger output or a PASS/FAIL output.

**No. of digitizers:** 2 or 4, one per channel.

**Vertical resolution:** 8 bits, all on screen (up to 12 bits with processing).

**Sample rate:** Up to 20 MS/sec for transients, up to 20 GS/sec for repetitive signals, simultaneously on all channels.

**DC accuracy:** ≤ ±2% full scale.

**Vertical expansion:** up to 5x normally, up to 50x with averaging.

**Offset:** 5 - 24.5 mV/div: ±0.8 V  
25.0 - 124.9 mV/div: ±4.0 V  
125 mV/div - 2 V/div: ±10.0 V

**TIMEBASE SYSTEM**

**Timebases:** Three, main and two delayed.

**Main timebase range:** 100 psec/div to 200 msec/div in 1, 2, 5 sequence.

**Delayed timebase range:** 100 psec/div to main timebase setting.

**Clock accuracy:** ≤ 0.002%.

**Interpolator resolution:** 10 psec.

**Interpolator accuracy:** < 15 psec.

**Maximum record length:** 5000 samples per channel.

**Acquisition modes:** Random interleaved sampling from 100 psec/div to 10 msec/div. Single shot from 0.1 msec/div to 200 msec/div. trigger system

**Pre-trigger time:** Adjustable in 1% increments up to 100% full scale (grid width).

**Post-trigger delay:** Adjustable in 0.1 division increments up to 10,000 divisions.

**Timing:** Trigger date and time stored with each waveform.

**External trigger input:** 50 Ω ±1%.

**External trigger voltage range:** ±0.5 V in EXT, ±5 V in EXT/10.

**Trigger rate:** Up to 1.5 GHz on one channel only, (CH2 in 9320, CH4 in

9324) when HF coupling selected; 750 MHz for all other inputs.

**Trigger jitter:** < 10 psec RMS.

**Trigger holdoff range:** By time 12.5 nsec to 20 sec in steps of 12.5 nsec, by events.

1 to 106, 100 MHz maximum rate.

**STANDARD TRIGGER**

**Trigger sources:** CH1, CH2, (CH1 to CH4 in 9324), Ext, Ext/10. CH1 to CH4 and EXT have independent trigger circuits allowing individual setting of slope, level and coupling.

**Slope:** Positive, negative.

**Coupling:** DC, AC-AUTOLEVEL, and HF (for one channel only).

**Modes:** Stop, auto, normal, single.

**SMART TRIGGER™**

Single source on any of CH1 to CH4 and EXT.

**Pulse or pattern width < or >:**

1 nsec to

1 msec in steps variable from 500 psec to 20 nsec.

**Pattern:** Trigger on the logic AND of the input channels (CH1 to CH4 in 9324, CH1 and CH2 in 9320), where each source can be defined as high (H), low (L) or don't care (X). The trigger can be selected at the beginning (entered) or at the end (exited) of the specified pattern. The pattern width can also be specified as above.

**State/edge qualified:** Triggers on any source (CH1 to CH4 + EXT) after the entering of a qualifying condition, edge or state, that can be defined on a single source or on a pattern of the input channels. The trigger can take place after (or within) a programmable delay ranging from 2 nsec to 1 msec in steps variable from 500 psec to 20 nsec. The state qualified trigger requires the continuing presence of the enabling pattern to trigger, while the edge qualified trigger does not.

**DISPLAY**

**CRT:** 12.5 x 17.5 cm (9" diagonal); raster.

**Resolution:** 810 x 696 pixels.

**Graticules:** Internally generated, separate intensity control for graticule and waveforms; single, dual and quad graticules.

**Display modes:** Normal, variable and infinite persistence, XY.

**AUTOMATIC MEASUREMENTS**

The following Parametric measurements are available, together with statistics of their Average, Highest, Lowest values and Standard Deviation:

base	duty cycle	peak to peak
cmean	falltime	period
cmedian	f80-20%	risetime
crms	f@level (abs)	r20-80%
csdev	f@level (%)	r@level (abs)
cycles	frequency	r@level (%)
delay	maximum	RMS
Δdelay	mean	std dev
Δt at level (abs) median		top
Δt at level (%) minimum		width

Parameters are calculated as defined by ANSI/IEEE Std 181-1977 "Standard on Pulse Measurement and Analysis by Objective Techniques". In addition, Rise and Fall times may be measured at 10 % and 90% levels, or 20% and 80% levels, or any other user-specified levels.

Δdelay provides time between midpoint transition of two sources, for making propagation delay measurements.

Δt at level allows the same measurement to be made at any specified level.

Two cursors are used to define the region over which these parameters are calculated.

**Relative Time:** Two cursors provide time measurements with resolution of ±0.05% full scale for unexpanded traces; up to 10 % of the sampling interval for expanded traces. The corresponding frequency value is also displayed.

**Relative Voltage:** Two horizontal bars measure voltage differences up to ±0.2% of fullscale in single-grid mode.

**Absolute Time:** A cross hair marker measures time relative to the trigger, and voltage with respect to ground.

**Pass/Fail testing** allow up to five of the listed parameters to be tested against selectable thresholds. Waveform Limit Testing is performed using templates which may be defined inside the instrument.

**WAVEFORM PROCESSING**

Waveform processing routines, up to four simultaneously, are called and set up via menus. These include arithmetic functions (add, subtract, multiply, divide, negate, identity), Sin(x)/x and summation averaging (up to 1000 sweeps).

**Function memories:** 4 x 5000 points, 16 bit.

**Optional processing:** Extra processing power can be added by installing LeCroy's waveform processing options, see page 41, 43 or 47.

amplitude	Δt at level (t=0,abs) overshoot +
area	Δt at level (t=0%) overshoot -



**Option WP01:** Provides averaging, summation (to 1,000,000 sweeps) and continuous, extended mathematics including integration, differentiation, log, exp, absolute value, square, square root, etc; high resolution mode, up to 11 bits; extrema mode for storage of extreme positive and negative values.

**Option WP02:** Provides FFT spectral analysis with a wide selection of displayed parameters.

#### AUTO-SETUP

Front panel button. Automatically scales timebase, trigger and sensitivity settings to correctly display repetitive signals with amplitudes between 10 mV and 5 V.

**Auto-setup time:** Approximately 2 sec, frequency above 50 Hz; duty cycle greater than 0.1%.

**Vertical find:** Individual per channel, automatically scales sensitivity and offset.

#### INTERFACING

**Remote control:** Of all front-panel controls, as well as all internal functions is possible by GPIB and RS-232.

**RS-232 port:** Asynchronous up to 19,200 baud for computer/terminal control or printer/plotter connection.

**GPIB port:** (IEEE-488.1) Configurable as talker/listener for computer control and fast data transfer. Command language complies with requirements of IEEE-488.2.

**Centronics:** Optional parallel interface. Included with floppy disk and graphics printer options.

**Hardcopy:** Screen dumps are activated by a front-panel button or via remote control. TIFF format is available for importing to DTP programs. The following printers and plotters can be used to make hardcopies: HP ThinkJet, QuietJet, LaserJet, PaintJet (color), DeskJet (color) and EPSON printers. HP 7400 and 7500 series, or HPGL compatible plotters.

#### STORAGE

**Reference memories:** 4 x 5000 points, 16 bits, usable to store acquired and processed waveforms.

**Setups:** Up to four stored in battery backed-up memories. Front-panel settings are maintained for two years. Three DOS-compatible mass storage options: 1.44 MB, 3.5" floppy disk, PCMCIA portable hard drive and/or up to 8 MB fast storage memory card, provide non-volatile mass storage of waveforms and/or front-panel setups.

#### SELF TESTS

Auto-calibration ensures specified DC and timing accuracy.

#### GENERAL

**Temperature:** 5°C to 40°C (41° to 104°F) rated, 0°C to 50°C (32° to 122°F) operating.

**Humidity:** < 80%.

**Shock & vibration:** Meets MIL-STD-810C modified to LeCroy design specifications and MIL-T-28800C.

**Power:** 90-250 V AC, 45-66 Hz, 150W.

**Battery backup:** Front-panel settings maintained for two years.

#### Dimensions:

(HWD) 8.5" x 14.5" x 16.25",  
210 mm x 370 mm x 410 mm.

**Weight:** 10 kg (22 lbs) net, 15.5 kg (34 lbs) shipping.

**Warranty:** 3 years.

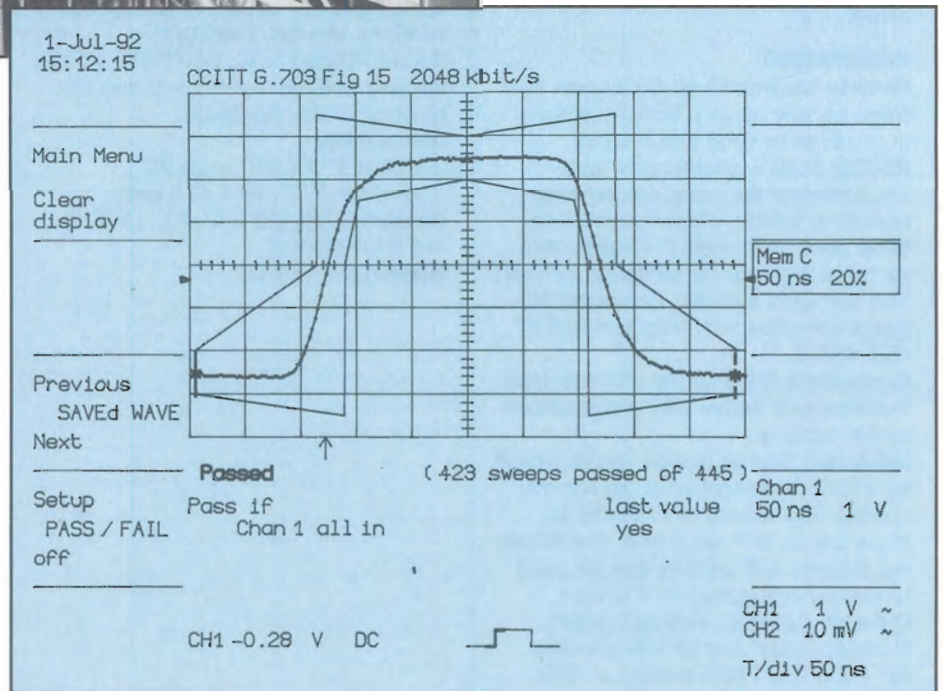
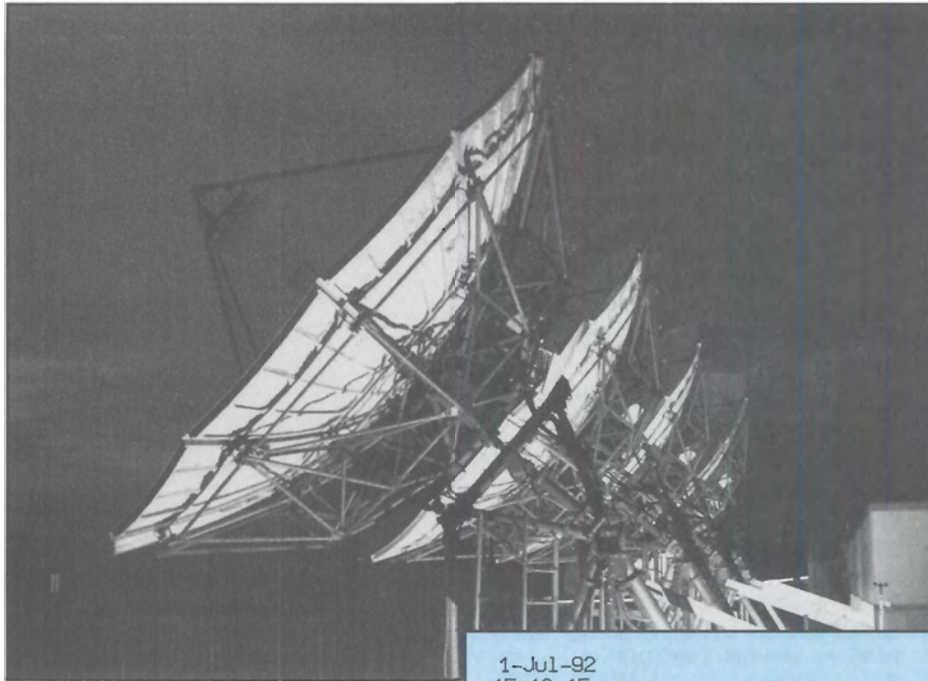

The 1 GHz bandwidth of the 9320 & 9324 combined with the trigger capabilities of the optional AP082 and AP083 are ideal for testing SONET/SDH 155 Mbps signals. Refer to Page 171 for more information.



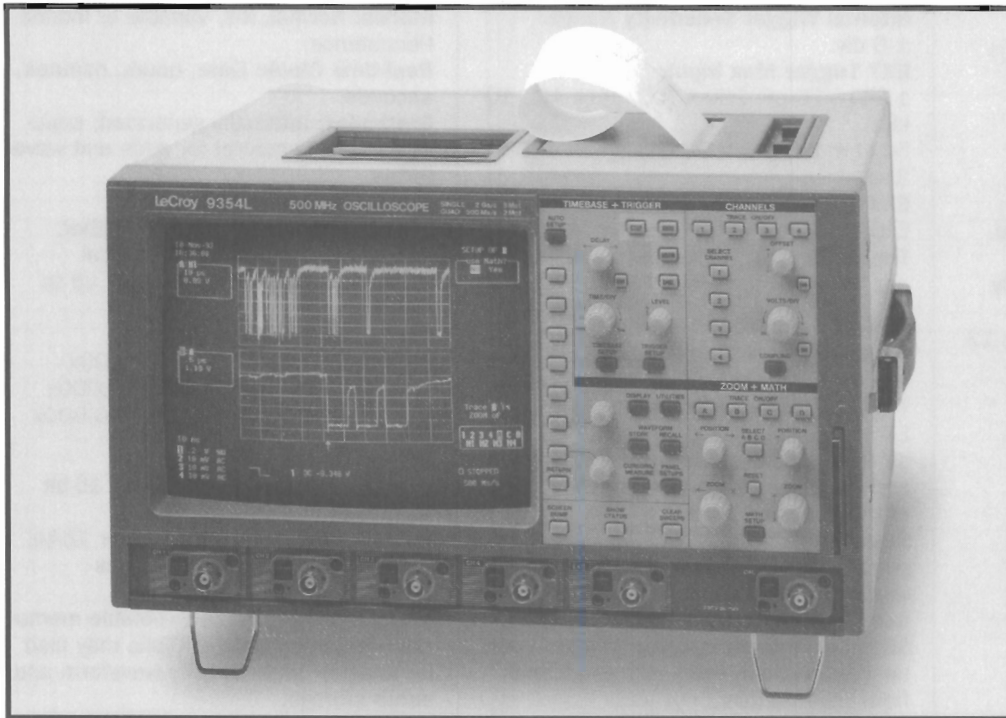

High speed and long memory make this family the ideal 500 MHz general-purpose Digital Storage Oscilloscopes. Two and four channel simultaneous sampling at 500 MS/s meets demanding high-speed design applications. Even faster sampling may be achieved by combining channels, up to a maximum of 2 GS/s. Acquisition memories may also be combined, providing up to 8 M points of continuous or segmented waveform recording. Repetitive signals are digitized at up to 10 GS/s.

A unique peak detect scheme triggers on glitches down to 1ns and keeps the ADC sampling at 2.5 ns - even at slow time bases - without destroying the underlying data. This provides circuit designers with the benefits of peak detection without any loss of precision.

Live waveforms on the main timebase may be viewed simultaneously with up to 3 expansions, showing all of the signal detail. Expansions are shown as highlights on the main trace. Each zoomed detail may be expanded horizontally and vertically as required.

SMART Trigger modes like Glitch, Pattern, Dropout and TV allow you to capture precisely the events of interest. Pre- and Post-Trigger delay, and Time and Events Holdoff are also standard. The 9350A family features the proven user-interface of LeCroy's portable scopes. A bright 9" CRT allows optimum waveform viewing on a high resolution 810 x 696 pixel screen. Menus and text are arranged around the graticules - they never overwrite the waveforms. Dedicated control knobs keep the scope's performance at your fingertips.

A comprehensive range of signal processing functions including FFT and Math on live or stored waveforms, allows extensive waveform manipulation. Up to 16 MBytes of RAM are standard allowing advanced processing including FFT's up to 1 Mpoint. For the most powerful processing in the industry, a 64 MByte RAM option is available, see Page 57. DOS compatible floppy disk, PCMCIA portable hard drive and memory card options store waveforms and test setups, and simplify data transfer to any PC. An optional high resolution graphics printer is also available.

## 9350A Family Digital Oscilloscopes 500 MHz Bandwidth, 2 GS/s

### Main Features

- Two and Four Channel versions
- Up to 8M Point record length
- DOS Compatible Floppy Disk, PCMCIA portable hard drive and Memory Card options
- Innovative Peak Detect Mode
- Glitch, Pattern, Qualified, Interval, Dropout and Video Triggers
- 8-bit vertical resolution, 11 with ERES option
- Fully programmable via GPIB and RS-232-C
- Automatic PASS/FAIL testing
- Advanced Signal Processing
- Internal High Resolution Graphics

**ACQUISITION SYSTEM****Bandwidth (-3 dB):** DC to 500 MHz**No. of Channels:**

4 (9354A) or 2 (9350A)

**No. of Digitizers:**

4 (9354A) or 2 (9350A)

**Maximum Sample Rate:**

2 GS/s (9354A) or 1 GS/s (9350A)

**Acquisition Memory:** Up to 8 M (see table below).**Sensitivity:** 2 mV/div to 5 V/div, fully variable.**Scale factors:** A wide choice of over 12 probe attenuation factors are selectable.**Offset Range:** 2.0 - 9.9 mV/div:  
± 120 mV

10.0 - 199 mV/div: ± 1.2 V

0.2 - 5.0 V/div: ± 24 V

±20 V across the whole sensitivity range when using the AP 020 FET probe.

**DC Accuracy:** ≤±2% full scale.**Vertical Resolution:** 8 bits.**Bandwidth Limiter:** 30 MHz**Input Coupling:** AC, DC, GND.**Input Impedance:** 1 MΩ//15 pF or 50 Ω ± 1%.**Max Input:**

1 MΩ: 250 V (DC+peak AC ≤ 10 kHz)

50 Ω: ± 5 V DC (500 mW) or 5 V RMS

**TIME BASE SYSTEM****Timebases:** Main and up to 4 Zoom Traces.**Time/Div Range:** 1 ns/div to 1000 s/div.**Clock Accuracy:** ≤ 10 ppm**Interpolator resolution:** 10 ps**Roll Mode:** Ranges 500 ms to 1,000 s/div.**For > 50k points:** 10 s to 1,000 s/div.**External Clock:** ≤ 100 MHz on EXT input with ECL, TTL or zero crossing levels up to 500 MHz with option 935XA-CKTRIG.**TRIGGERING SYSTEM****Trigger Modes:** Normal, Auto, Single.**Trigger Sources:** CH1, CH2, Line, Ext, Ext/10 (9354: CH3, CH4), Slope, Level and Coupling for each can be set independently.**Slope:** Positive, Negative.**Coupling:** AC, DC, HF, LFREJ, HFREJ.

Pre-trigger recording: 0 to 100% of full scale (adjustable in 0.1 div increments).

**Post-trigger delay:** 0 to 10,000 divisions (adjustable in 0.01% increments).**Holdoff by time:** 10 ns to 20 s.**Holdoff by events:** 0 to 99,999,999 events.**Trigger Bandwidth:** Up to 500 MHz using HF coupling.**Internal Trigger Sensitivity Range:**

± 5 div.

**EXT Trigger Max Input:**

1 MΩ//15 pF: 250 V (DC+peak AC ≤ 10 kHz)

50 Ω ± 1%: ± 5 V DC (500 mW) or 5 V RMS

**EXT Trigger Range:** ±0.5 V (±5 V with Ext/10)**Trigger Timing:** Trigger Date and Time are listed in the Memory Status Menu.**SMART TRIGGER TYPES****Pattern:** Trigger on the logic AND of 5 inputs - CH1, CH2, CH3, CH4, and EXT Trigger, (9350: 3 inputs - CH1, CH2, EXT) where each source can be defined as High, Low or Don't Care. The Trigger can be defined as the beginning or end of the specified pattern.**Signal or Pattern Width:** Trigger on glitches as short as 1 nsec or on pulse widths between two limits selectable from < 2.5ns to 20s.**Signal or Pattern Interval:** Trigger on an interval between two limits selectable from 10ns to 20s.**Dropout:** Trigger if the input signal drops out for longer than a time-out from 25ns to 20s.**State/Edge Qualified:** Trigger on any source only if a given state (or transition) has occurred on another source.

The delay between these events can be defined as a number of events on the trigger channel or as a time interval.

**TV:** Allows selection of both line (up to 1500) and field number (up to 8) for PAL, SECAM, NTSC or non-standard video.**ACQUISITION MODES****Random Interleaved Sampling (RIS):**

for repetitive signals from 1 ns/div to 2 μs/div (M,L versions: from 1 ns/div to 5 μs/div).

**Single shot:** for transient and repetitive signals from 10 ns/div (all channels active).**Peak detect:** captures and displays 2.5 ns glitches or other high-speed events.**Sequence:** Stores multiple events - each of them time stamped - in segmented acquisition memories.

Number of segments available:

9350A-9354A 2-50

9350AM-9354AM-9354TM 2-500

9350AL-9354AL 2-2,000

**DISPLAY****Waveform style:** Vectors connect the individual sample points, which are highlighted as dots. Vectors may be switched off.**CRT:** 12.5 x 17.5 cm (9" diagonal) raster.**Resolution:** 810 x 696 points.**Modes:** Normal, X-Y, Variable or Infinite Persistence.**Real-time Clock:** Date, hours, minutes, seconds.**Graticules:** Internally generated; separate intensity control for grids and waveforms.**Grids:** 1, 2 or 4 grids.**Formats:** YT, XY, and both together.**Vertical Zoom:** Up to 5x Vertical Expansion (50x with averaging, up to 40 μV sensitivity).**Horizontal Zoom Factors:**

9350A-9354A 500x

9350AM-9354AM-9354TM 2,000x

9350AL-9354AL 40,000x

**INTERNAL MEMORY****Waveform Memory:** Up to four 16-bit Memories (M1,M2,M3,M4).**Processing Memory:** Up to four 16-bit Waveform Processing Memories (A,B,C,D).**Setup Memory:** Four non-volatile memories. Optional Cards or Disks may also be used for high-capacity waveform and setup storage.**AUTOMATIC MEASUREMENTS**

The following Parametric measurements are available, together with statistics of their Average, Highest, Lowest values and Standard Deviation:

amplitude	Δt at level (t=0,abs)	overshoot +
area	Δt at level (t=0%)	overshoot -
base	duty cycle	peak to peak
cmean	falltime	period
cmedian	f80-20%	risetime
crms	f@level (abs)	r20-80%
csdev	f@level (%)	r@level (abs)
cycles	frequency	r@level (%)
delay	maximum	RMS
Δdelay	mean	std dev
Δt at level (abs)	median	top
Δt at level (%)	minimum	width

Parameters are calculated as defined by ANSI/IEEE Std 181-1977 "Standard on Pulse Measurement and Analysis by Objective Techniques". In addition, Rise and Fall times may be measured at 10 % and 90% levels, or 20% and 80% levels, or any other user-specified levels.

Δdelay provides time between midpoint transition of two sources, for making propagation delay measurements.

Δt at level allows the same measurement to be made at any specified level.

Two cursors are used to define the region over which these parameters are calculated.



**Relative Time:** Two cursors provide time measurements with resolution of  $\pm 0.05\%$  full scale for unexpanded traces; up to 10 % of the sampling interval for expanded traces. The corresponding frequency value is also displayed.

**Relative Voltage:** Two horizontal bars measure voltage differences up to  $\pm 0.2\%$  of fullscale in single-grid mode.

**Absolute Time:** A cross hair marker measures time relative to the trigger, and voltage with respect to ground.

**Pass/Fail** testing allow up to five of the listed parameters to be tested against selectable thresholds. Waveform Limit Testing is performed using templates which may be defined inside the instrument.

### WAVEFORM PROCESSING

Up to four processing functions may be performed simultaneously. Functions available are: Add, Subtract, Multiply, Divide, Negate, Identity, Sin (x)/x and Summation Averaging.

**Average:** Summed averaging of up to 1,000 waveforms in the basic instrument. Up to a million sweeps are possible with Option WPO1.

**Envelope\*:** Max, Min, or Max and Min values of up to one million sweeps.

**ERES\*:** Low-Pass digital filter provides up to 11 bits vertical resolution. Sampled data is always available, even when a trace is turned off. Any of the above modes can be invoked without destroying the data.

**FFT\*:** Spectral Analysis with four windowing functions and FFT averaging.

\*Envelope and ERES modes are provided in Math Package WPO1, FFT is in WPO2.

### AUTOSETUP

Pressing Autosetup sets timebase, trigger and sensitivity to display a wide range of repetitive signals. (Amplitude 2mV to 40V; frequency above 50Hz; Duty cycle greater than 0.1%).

**Autosetup Time:** Approximately 2 seconds.

**Vertical Find:** Automatically sets sensitivity and offset.

### PROBES

**Model:** One PP002 (X10, 10 M $\Omega$  // 15 pF) probe supplied per channel. The 9350 family is fully compatible with LeCroy's range of FET Probes, which may be purchased separately.

**Probe calibration:** Max 1 V into 1 M $\Omega$ , 500 mV into 50  $\Omega$ , frequency and amplitude programmable, pulse or square wave selectable, rise and fall time 1 ns typical.

Alternatively, the Calibrator output can provide a trigger output or a PASS/FAIL test output.

### INTERFACING

**Remote Control:** All front-panel controls, as well as all internal functions are possible by GPIB and RS-232-C.

**RS-232-C Port (Standard):** Asynchronous up to 19200 baud for computer/terminal control or printer/plotter connection.

**GPIB Port (Standard):** (IEEE-488.1) Configurable as talker/listener for computer control and fast data trans-

fer. Command Language complies with requirements of IEEE-488.2.

**Centronics Port:** Optional hardcopy parallel interface included with floppy disk and graphics printer option.

**Hardcopy:** Screen dumps are activated by a front-panel button or via remote control. TIFF format is available for importing into Desktop Publishing programs. The following printers and plotters can be used to make hardcopies: HP DeskJet (color or B&W), HP ThinkJet, QuietJet, LaserJet, PaintJet and EPSON printers. HP 7400 and 7500 series, or HPGL compatible plotters.

An optional internal high resolution graphics printer is also available, see Page 53.

### GENERAL

Auto-calibration ensures specified DC and timing accuracy.

**Temperature:** 5° to 40° C (41° to 104° F) rated, 0° to 50° C (32° to 122° F) operating.

**Humidity:** < 80%.

**Shock & Vibration:** Meets MIL-STD-810C modified to LeCroy design specifications and MIL-T-28800C.

**Power:** 90-250 V AC, 45-66 Hz, 230 W.

**Battery Backup:** Front-panel settings maintained for two years.

**Dimensions:** (HWD) 8.5" x 14.5" x 16.25", 210mm x 370mm x 410mm.

**Weight:** 13 kg (28.6 lbs) net, 18.5 kg (40.7 lbs) shipping.

**Warranty:** 3 years.

Memory Per Channel						
Channels Used	Maximum Sample Rate	9350A 9354A	9350AM 9354AM	9354TM	9350AL 9354AL	Notes
All, Peak Detect OFF	500 MS/s	50k	250k	500k	2M	All channels active
All, Peak Detect ON	100 MS/s data 400 MS/s peak	25k data+ 25k peaks	100k data + 100k peaks	250k data + 250k peaks	1M data + 1M peaks	All channels active 2.5 ns peak detect
Paired Peak Detect OFF	1 GS/s	100k	500k	1M	4M	9350A; CH1 9354A; Ch2 + Ch3
Paired + PP092 Peak Detect OFF	2 GS/s	200k	1M	2M	8M	9354A Models Only

For Ordering Information See Page 62

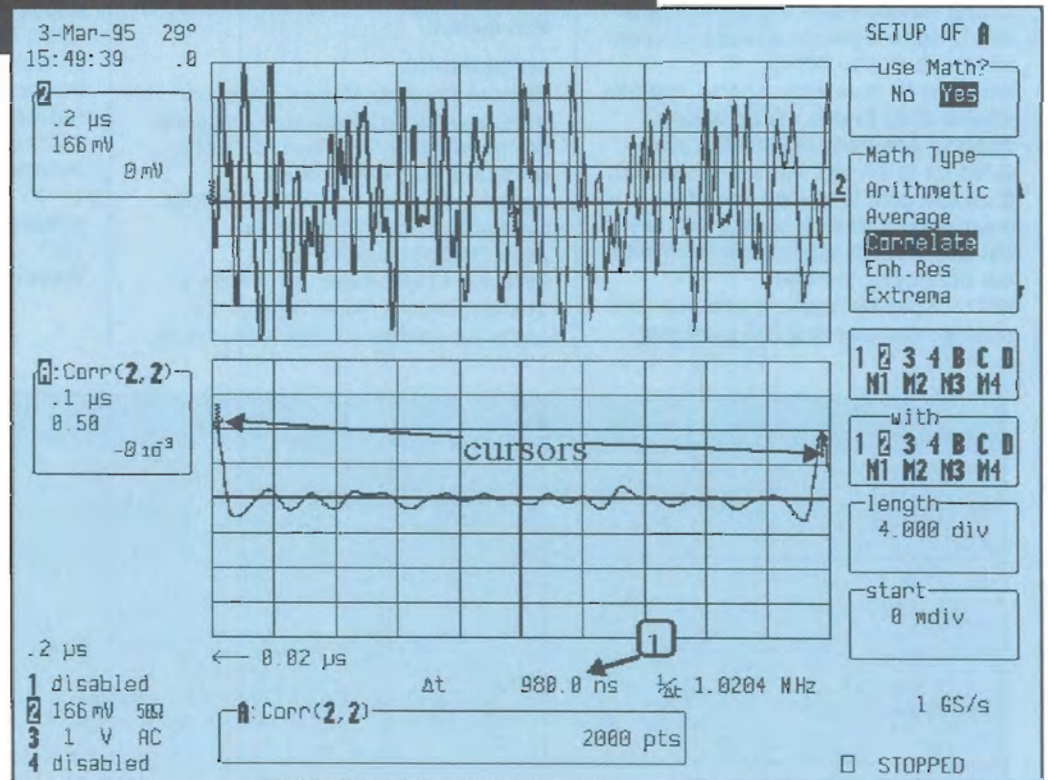

The 93XX-DDM and 93XX-PRML packages allow 9350A series scopes to make powerful measurements on magnetic media. Above is an autocorrelation measurement. Refer to the DDM/PRML technical data on Page 49 and "Making PRML Measurements with DSO's on Page 157 for more information.



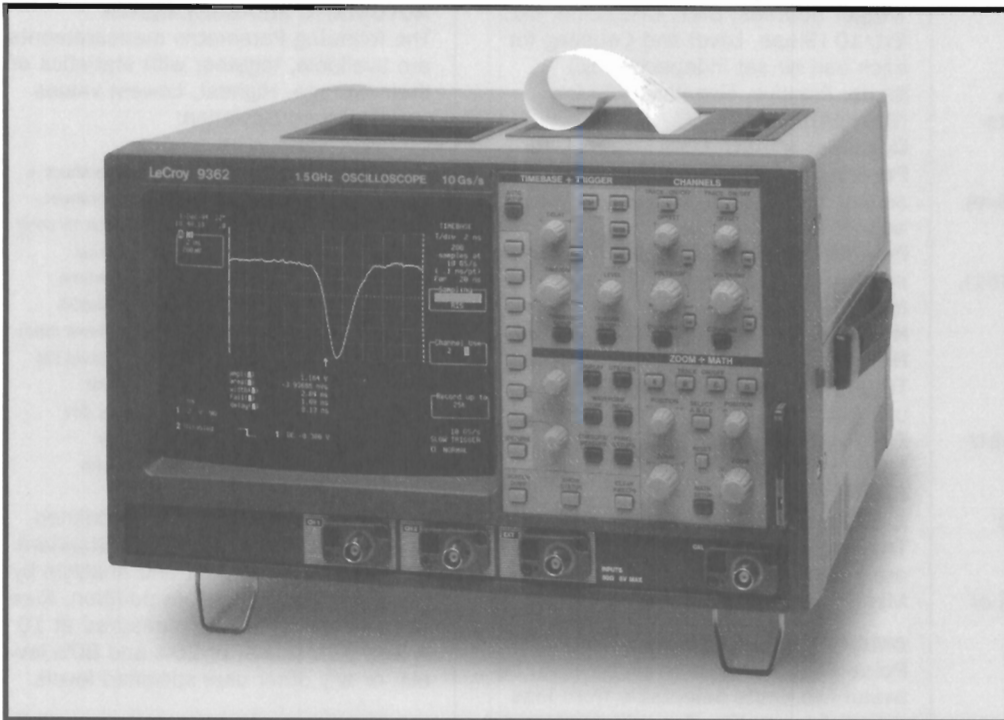

## 9361, 9362 Fast Digitizing Oscilloscopes

### Main Features

- 10 GS/s max single shot sampling on 9362, 2.5 GS/s on 9361
- Repetitive sampling mode with 1.5 GHz bandwidth on 9362
- 750 MHz single-shot bandwidth on 9362, 300 MHz on 9361
- Single-shot acquisition available on all timebases
- 8-bit vertical resolution; 11 with ERES option
- Glitch, Interval, Dropout, Video and State-Qualified Triggers
- Advanced signal processing
- Record length to 25,000 points
- Automatic PASS/FAIL testing
- 36 Automatic measurements
- Internal 3.5" floppy disk and PCMCIA portable hard drive storage options
- Internal high resolution graphics printer option

The 9362's 10 GS/s sample rate makes it the fastest single shot digital scope available. It is ideal for applications like digital design, which require high bandwidth single-shot acquisition. Its two independent digitizers are clocked simultaneously to make precise timing measurements. Fast single-shot pulses can be characterized with 100 psec resolution in single channel mode or 200 psec resolution using both channels.

With 1.5 GHz bandwidth, the 9362 is also ideal for characterizing high-speed repetitive signals. Optional FET probes ensure low loading and high bandwidth.

The 9361 is an excellent oscilloscope for looking at single shot events with slower risetimes. It samples on 2 channels simultaneously at 2.5 GS/s sampling rate with 300 MHz bandwidth.

SMART Trigger modes like Glitch, Window and Dropout allow you to capture precisely the events of interest. Once signals are triggered, a range of signal processing functions, on live or stored waveforms, allows

waveform manipulation without destroying the underlying data.

Menus and text are arranged around the waveform graticules - they never overwrite the waveforms. Each of the main control functions is dedicated to a single knob, to keep the scope's performance at your fingertips.

The 9360 series features the proven user-interface of LeCroy's portable scope family. A bright 9" CRT allows optimum waveform viewing on a high resolution 810 x 696 pixel screen.

Optional packages for FFT and extensive Waveform Processing (including Enhanced Resolution processing to 11 bits) are available.

DOS compatible memory card, PCMCIA portable hard drive and floppy disk options store waveforms and test setups, and make transferring data to your PC easier than ever before. An optional high resolution graphics printer is also available.

**ACQUISITION****No. of Channels:** 2**No. of Digitizers:** 2**Maximum Sample Rate:** 10 GS/s in single channel mode, 5 GS/s simultaneously on each channel for 9362, 2.5 GS/s for 9361.**Bandwidth (-3 dB):** 1.5 GHz (repetitive) 750 MHz (single shot) for 9362, 300 MHz for 9361.**Sensitivity:** 2 mV/div to 5 V/div (9361), to 1 V (9362), fully variable.**Offset Range:**  $\pm 8$  divisions.**DC Accuracy:**  $\pm(3\% \text{ FS} + 3\% \text{ offset} + 1\text{mV})$ .**Vertical Resolution:** 8 bits.**Analog Bandwidth Selections:** 30 MHz (9361 only) and full.**Input Coupling:** AC, DC, GND.**Input Impedance:** 1 M $\Omega$ ||15 pF 50 $\Omega$   $\pm 1\%$  or 1 M $\Omega$ ||15 pF (9361 only).**Max Input:** 1 M $\Omega$ :250V (DC+peak AC<10KHz) 50 $\Omega$ : $\pm 5\text{V DC}$  (500 mW) or 5VRMS.**Scale Factors:** Probe attenuation is sensed automatically.**WAVEFORM PROCESSING**

Up to four processing functions may be performed simultaneously. Available functions are: Add, Subtract, Multiply, Divide, Negate, Identity, Sin (x)/x and the following:

**Average:** Summed averaging of up to 1,000 waveforms in the basic instrument. Up to 10<sup>6</sup> averages are possible with Option WP01.**Envelope\*:** Max, Min, or Max and Min values of from 1 to 10<sup>6</sup> waveforms are displayed.**ERES\*:** Low-Pass digital filter provides up to 11 bits vertical resolution.**Sample:** Sample data is always available, even when trace is turned off. Any of the above modes can be invoked without destroying the sample data.

\*Envelope and ERES modes are provided in Optional Math Package WP01.

**TIME BASE SYSTEM****Timebases:** Main and up to 4 Zoom Traces. Any 4 viewed simultaneously.**Time/Div Range:** 1 ns/div to 1000 s/div.**Timebase Accuracy:**  $\pm 0.07\%$ .**Record Length:** 500 to 25,000 points (500 points for timebase settings from 500 ns/div to 1 ns/div).**Roll Mode:** on ranges 500 ms to 1000 s/div.**TRIGGERING SYSTEM****Trigger Modes:** Normal, Auto, Single, Stop.**Trigger Sources:** CH1, CH2, Line, Ext, Ext/10 (Slope, Level and Coupling for each can be set independently.)**Slope:** Positive, Negative, Window (BiSlope).**Coupling:** AC, DC, LFREJ, HFREJ, HF.**Pre-trigger recording:** 0 to 100% of full scale (0 to 75% at 10ns/div) adjustable in 1% steps.**Post-trigger delay:** 0 to 10,000 divisions (adjustable in 0.1 div increments).**Holdoff by time:** 25 ns to 20s.**Holdoff by events:** 0 to 109 events.**Trigger Bandwidth:** Up to 500 MHz using HF coupling.**Ext Trigger Input:** 1 M $\Omega$ ||15pF, 250V Max.**Ext Trigger Range:** $\pm 500\text{mV}$ ,  $\pm 5\text{V}$  with Ext/10**Trigger Timing:** Trigger Date and Time are listed in the Waveform Status Menu.**SMART TRIGGER TYPES****Pulse Width:** Trigger on pulse width between two limits selectable from less than 2.5ns to 20s. Typically triggers on glitches down to 1 ns.**Interval Width:** Trigger on pulse spacing between two limits selectable from 2.5ns to 20s.**Dropout:** Trigger if the input signal drops out for longer than a timeout from 25ns to 20s.**State/Edge Qualified:** Trigger on any source only if a given state (or transition) has occurred on one of the other possible sources. The delay between these events can be defined as a number of events on the trigger channel.**TV:** Allows selection of both line (up to 1500) and field number (up to 8) for PAL, SECAM, NTSC or non-standard video.**DISPLAY****Waveform style:** Vectors connect the individual sample points, which are highlighted as dots.**CRT:** 12.5x17.5 cm (9" diagonal) raster.**Resolution:** 810x696 points.**Modes:** Normal, X-Y, Persistence.**Real-time Clock:** Date, hours, minutes, sec.**Graticules:** Internally generated; separate intensity control for grids and waveforms.**Grids:** 1, 2 or 4 grids.**Formats:** YT, XY, and both together.**Persistence:** Normal or Infinite.**Zoom:** Up to 200x Horizontal and up to 5x Vertical Expansion (50x with averaging, up to 40 mV sensitivity).**AUTOMATIC MEASUREMENTS**

The following Parametric measurements are available, together with statistics of their Average, Highest, Lowest values and Standard Deviation:

amplitude	$\Delta t$ at level (t=0,abs)	overshoot +
area	$\Delta t$ at level (t=0%)	overshoot -
base	duty cycle	peak to peak
cmean	falltime	period
cmedian	f80-20%	risetime
crms	f@level (abs)	r20-80%
csdev	f@level (%)	r@level (abs)
cycles	frequency	r@level (%)
delay	maximum	RMS
$\Delta$ delay	mean	std dev
$\Delta t$ at level (abs)	median	top
$\Delta t$ at level (%)	minimum	width

Parameters are calculated as defined by ANSI/IEEE Std 181-1977 "Standard on Pulse Measurement and Analysis by Objective Techniques". In addition, Rise and Fall times may be measured at 10 % and 90% levels, or 20% and 80% levels, or any other user-specified levels.

 $\Delta$ delay provides time between midpoint transition of two sources, for making propagation delay measurements. $\Delta t$  at level allows the same measurement to be made at any specified level.

Two cursors are used to define the region over which these parameters are calculated.

**Relative Time:** Two cursors provide time measurements with resolution of  $\pm 0.05\%$  full scale for unexpanded traces; up to 10 % of the sampling interval for expanded traces. The corresponding frequency value is also displayed.**Relative Voltage:** Two horizontal bars measure voltage differences up to  $\pm 0.2\%$  of fullscale in single-grid mode.**Absolute Time:** A cross hair marker measures time relative to the trigger, and voltage with respect to ground.**Pass/Fail** testing allow up to five of the listed parameters to be tested against selectable thresholds. Waveform Limit Testing is performed using templates which may be defined inside the instrument.**INTERNAL MEMORY****Waveform Memory:** Four 16-bit Reference Memories (M1,M2,M3,M4) for full 25k records.**Processing Memory:** Four 16-bit Waveform Processing Memories (A,B,C,D) 25k each.



**Setup Memory:** Four non-volatile panel memories.

#### AUTOSETUP

Sets timebase, trigger and sensitivity to display a wide range of repetitive signals. (Amplitude 2mV to 40V; frequency above 50Hz; Duty Cycle > 0.1%).

**Autosetup Time:** Approximately 2 seconds.

**Vertical Find:** Automatically sets sensitivity & offset.

#### INTERFACING

Remote Control of all front-panel controls, as well as all internal functions, is possible by GPIB and RS-232.

**RS-232 Port:** Asynchronous up to 19200 baud for computer/terminal control or printer/plotter connection.

**GPIB Port:** (IEEE-488.2) Talker/listener for computer control and fast data transfer.

**Hardcopy:** Screenshot dumps are activated by a front-panel button or via remote control. TIFF format is available for importing to DTP programs. The following printers and plotters can be used to make hardcopies:

HP ThinkJet, QuietJet, LaserJet, PaintJet and EPSON compatible printers. HP 7400 and 7500 series, Phillips 8151, Graphtek FP5301 and compatible plotters. An internal high resolution graphics printer is also available.

#### MASS STORAGE OPTIONS

Optional 3.5" Floppy Disk drive and PCMCIA standard portable hard drive and memory cards allow storage of traces, screen graphics, setups and Pass/Fail templates.

#### GENERAL

**Temperature:**

10° to 35° C (50° to 95° F) rated, 0° to 45° C (32° to 113° F) operating

**Humidity:** <80%

**Shock & Vibration:** Meets MIL-STD-810C modified to LeCroy design specifications, and MIL-T-28800C

**Power:** 90-250 V AC, 45-66 Hz, 150W

**Battery Backup:** Front-panel settings maintained for two years

**Dimensions:** (HWD)

8.5"x14.5"x16.25" 210mm x 370mm x 410mm

**Weight:** 10kg (22lbs) net 15.5kg (34lbs) shipping

**Warranty:** 3 years

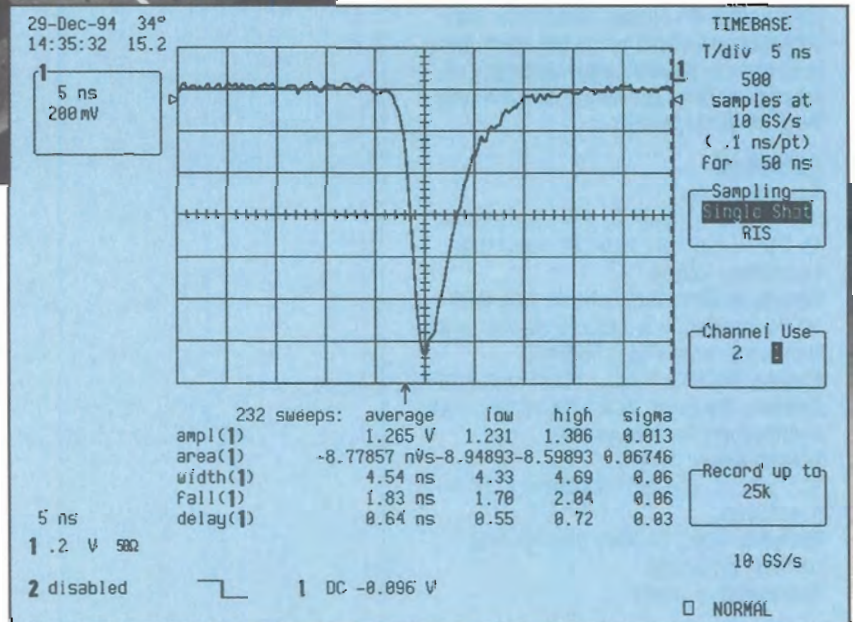
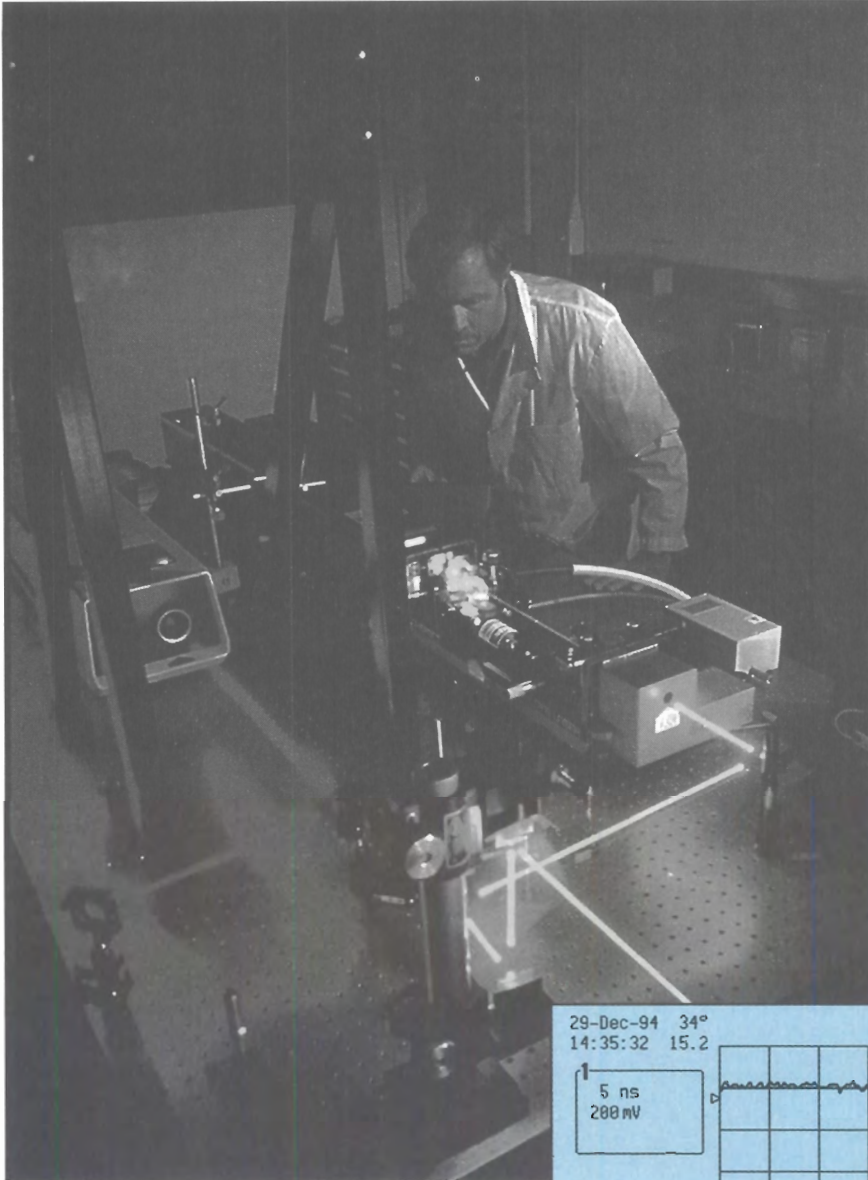

Here the 9362 captures a laser pulse 232 times and measures the amplitude, area, falltime of the fast leading edge, width and delay (jitter) of the pulse relative to a timing reference. The average, maximum, minimum and standard deviation of all the values is displayed.



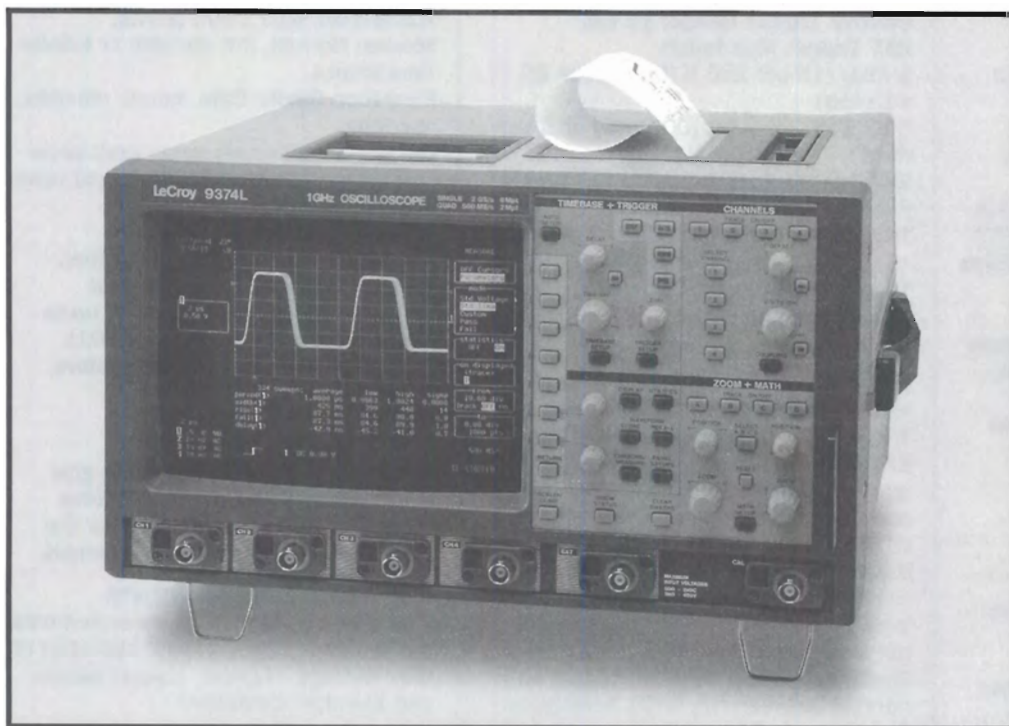

### 1 GHZ BANDWIDTH

The 9370 series digital storage oscilloscope opens up new horizons for engineers and scientists at the leading edge of technological developments. With 1 GHz bandwidth and long acquisition memories, it is now possible to reveal previously hidden waveform details. Narrow glitches are more accurately defined; risetime measurements below 1 nanosecond are more precise; and high-frequency content, filtered out in lower bandwidth systems, is retained, thereby preserving signal amplitudes and overall signal integrity.

### 2 GS/S SAMPLE RATE

The two and four channel models of the 9370 series sample simultaneously on all channels at 500 MS/s. Thus, they are ideal for demanding high speed applications. In addition, two channels can be combined to provide a sample rate of 1 GS/s. The 9374 provides 2 GS/s in single channel mode. Finer horizontal resolution and accuracy are guaranteed by high sample rates. This is especially critical in digital design where unpredictable circuit

behavior has to be identified and analyzed in detail to be fully understood. Together with this excellent single-shot performance the 9370 series also provides a sample rate equivalent to 10 GS/s for repetitive signals.

### 8M POINTS ACQUISITION MEMORY

Channel memory lengths of 50k, 250k and 2M are available on the two and four channel 9370 DSOs. The memory power is revealed when the user seeks to sample at the highest speed over many timebase settings. Short memory DSOs may boast a high sample rate for short waveforms, but only a long memory oscilloscope can deliver high sample rates for long waveforms. To exploit this capability to its fullest the LeCroy 9370 series combines its channel acquisition memories to give the user up to 8 million sample points, thereby providing the waveform detail required on long and complex signals.

The combined capabilities of the 9370 series place it in the forefront of DSO capability.

## 9370 Series Digital Oscilloscopes 1 GHz Bandwidth, 2 GS/s

### Main Features

- Up to 8M Point record length
- 8-bit vertical resolution, 11 with ERES option
- Two and Four Channel versions
- Portable Hard Disk (PCMCIA III), Memory Card and DOS Compatible Floppy Disk options
- Innovative Peak Detect
- Glitch, Pattern, Qualified, Interval, Dropout and TV Triggers
- Fully programmable via GPIB and RS-232-C
- Internal Graphics Printer Option
- Automatic PASS/FAIL testing
- Advanced Signal Processing

**ACQUISITION SYSTEM****Bandwidth (-3 dB):**

@ 50Ω: DC to 1 GHz 10 mV/div and above

@ 1 MΩ DC: DC to 500 MHz typ. at probe tip, with PP004 supplied standard. 1 GHz FET probe optional.

**No. of Channels:** 4 (9374) or 2 (9370)

**No. of Digitizers:** 4 (9374) or 2 (9370)

**Maximum Sample Rate and Acquisition**

**Memories:** See table below.

**Sensitivity:**

2 mV/div to 1 V/div, 50Ω, fully variable

2 mV/div to 10 V/div, 1MΩ, fully variable.

**Scale factors:** A wide choice of probe attenuation factors are selectable.

**Offset Range:**

2.00 - 4.99 mV/div: ±400 mV

5.00 - 99 mV/div: ±1 V

0.1 - 1.0 V/div: ±10 V

1.0 - 10V/div: ± 100 V (1MΩ only)

**DC Accuracy:** Typically 1% for DC gain and offset at 0V.

**Vertical Resolution:** 8 bits.

**Bandwidth Limiter:** 20 MHz, 200 MHz.

**Input Coupling:** AC, DC, GND.

**Input Impedance:** 1MΩ//15 pF or 50 Ω ±1%.

**Max Input:**

1 MΩ: 400 V (DC+peak AC @10 kHz)

50Ω: ±5 V DC (500 mW) or 5 V RMS

**TIME BASE SYSTEM**

**Timebases:** Main and up to 4 Zoom Traces.

**Time/Div Range:** 1 ns/div to 1,000 s/div.

**Clock Accuracy:** ≤10 ppm

**Interpolator resolution:** 10 ps

**Roll Mode:** Ranges 500 ms to 1,000 s/div.

**For > 50k points:** 10 s to 1,000 s/div.

**External Clock:** ≤100 MHz on EXT input with ECL, TTL or zero crossing levels.

Optional 50 MHz to 500 MHz rear panel fixed frequency clock input.

**External Reference:** Optional 10 MHz rear-panel input.

**TRIGGERING SYSTEM**

**Trigger Modes:** Normal, Auto, Single, Stop.

**Trigger Sources:** CH1, CH2, Line, Ext, Ext/10 (9374: CH3, CH4). Slope, Level and Coupling for each source can be set independently.

**Slope:** Positive, Negative.

**Coupling:** AC, DC, HF, LFREJ, HFREJ.

**Pre-trigger recording:** 0 to 100% of full scale (adjustable in 1% increments).

**Post-trigger delay:** 0 to 10,000 divisions (adjustable in 0.1 div increments).

**Holdoff by time:** 10 ns to 20 s.

**Holdoff by events:** 0 to 99,999,999 events.

**Internal Trigger Range:** ±5 div.

**EXT Trigger Max Input:**

1 MΩ//15 pF: 250 V (DC + peak AC ≤10 kHz)

50Ω ±1%: ±5 V DC (500 mW) or 5 V RMS

**EXT Trigger Range:** ±0.5 V (±5 V with Ext/10)

**Trigger Timing:** Trigger Date and Time are listed in the Memory Status Menu.

**Trigger Comparator:** Optional ECL rear panel output.

**SMART TRIGGER TYPES**

**Pattern:** Trigger on the logic AND of 5 inputs - CH1, CH2, CH3, CH4, and EXT Trigger, (9370: 3 inputs - CH1, CH2, EXT) where each source can be defined as High, Low or Don't Care. The Trigger can be defined as the beginning or end of the specified pattern.

**Signal or Pattern Width:** Trigger on width between two limits selectable from 2.5ns to 20s. Will typically trigger on glitches 1ns wide.

**Signal or Pattern Interval:** Trigger on interval between two limits selectable from 10ns to 20s

**Dropout:** Trigger if the input signal drops out for longer than a time-out from 25ns to 20s.

**State/Edge Qualified:** Trigger on any source only if a given state (or transition) has occurred on another source. The delay between these events can be defined as a number of events on the trigger channel or as a time interval.

**TV:** Allows selection of both line (up to 1500) and field number (up to 8) for PAL, SECAM, NTSC or nonstandard video.

**ACQUISITION MODES****Random Interleaved Sampling (RIS):**

For repetitive signals from 1 ns/div to 5 ms/div.

**Single shot:** For transient and repetitive signals from 10 ns/div (all channels active).

**Peak detect:** Captures and displays 2.5 ns glitches or other high-speed events.

**Sequence:** Stores multiple events in segmented acquisition memories.

**Number of segments available:**

9370-9374 2-200

9370M-9374M 2-500

9370L-9374L 2-2,000

Max. Dead Time between segments: 100 μs

**DISPLAY**

**Waveform style:** Vectors connect the individual sample points, which are highlighted as dots. Vectors may be switched off.

**CRT:** 12.5x17.5 cm (9" diagonal) raster.

**Resolution:** 810 x 696 points.

**Modes:** Normal, X-Y, Variable or Infinite Persistence.

**Real-time Clock:** Date, hours, minutes, seconds.

**Graticules:** Internally generated; separate intensity control for grids and waveforms.

**Grids:** 1, 2 or 4 grids.

**Formats:** YT, XY, and both together.

**Vertical Zoom:** Up to 5x Vertical Expansion (50x with averaging, up to 40 mV sensitivity, only with WP01).

**Maximum Horizontal Zoom Factors:**

9370-9374 2,000x

9370M-9374M 10,000x

9370L-9374L 80,000x

Waveforms can be expanded to give 2-2.5 points/division. This provides zoom factors up to 400,000x for the 9374L when channels are combined.

**AUTOMATIC MEASUREMENTS**

The following Parametric measurements are available, together with statistics of their Average, Highest, Lowest values and Standard Deviation:

amplitude	Δt at level (t=0,abs)	overshoot +
area	Δt at level (t=0%)	overshoot -
base	duty cycle	peak to peak
cmean	falltime	period
cmedian	f80-20%	risetime
crms	f@level (abs)	r20-80%
csdev	f@level (%)	r@level (abs)
cycles	frequency	r@level (%)
delay	maximum	RMS
Δdelay	mean	std dev
Δt at level (abs)	median	top
Δt at level (%)	minimum	width

Parameters are calculated as defined by ANSI/IEEE Std 181-1977 "Standard on Pulse Measurement and Analysis by Objective Techniques". In addition, Rise and Fall times may be measured at 10 % and 90% levels, or 20% and 80% levels, or any other user-specified levels.

Δdelay provides time between midpoint transition of two sources, for making propagation delay measurements.

Δt at level allows the same measurement to be made at any specified level.

Two cursors are used to define the region over which these parameters are calculated.

**Relative Time:** Two cursors provide time measurements with resolution of ±0.05% full scale for unexpanded traces; up to 10 % of the sampling interval for expanded traces. The corresponding frequency value is also displayed.



**Relative Voltage:** Two horizontal bars measure voltage differences up to  $\pm 0.2\%$  of fullscale in single-grid mode.

**Absolute Time:** A cross hair marker measures time relative to the trigger, and voltage with respect to ground.

**Pass/Fail** testing allow up to five of the listed parameters to be tested against selectable thresholds. Waveform Limit Testing is performed using templates which may be defined inside the instrument.

#### INTERNAL MEMORY

**Waveform Memory:** Up to four 16-bit Memories (M1, M2, M3, M4).

**Processing Memory:** Up to four 16-bit Waveform Processing Memories (A, B, C, D).

**Setup Memory:** Four non-volatile memories. Optional Cards or Disks may also be used for high-capacity waveform and setup storage.

#### WAVEFORM PROCESSING

Up to four processing functions may be performed simultaneously.

Functions available are: Add, Subtract, Multiply, Divide, Negate, Identity, Summation Averaging and Sin (x)/x.

**Average:** Summed averaging of up to 1,000 waveforms in the basic instrument. Up to  $10^6$  averages are possible with Option WPO1.

**Extrema\*:** Roof, Floor, or Envelope values from 1 to  $10^6$  sweeps.

**ERES\*:** Low-Pass digital filter provides up to 11 bits vertical resolution. Sampled data is always available, even when a trace is turned off.

Any of the above modes can be invoked without destroying the data.

**FFT\*:** Spectral Analysis with five windowing functions and FFT averaging.

\*Extrema and ERES modes are provided in Math Package WPO1. FFT is in WPO2.

#### AUTOSETUP

Pressing Autsetup sets timebase, trigger and sensitivity to display a wide range of repetitive signals. (Frequency above 50Hz; Duty cycle greater than 0.1%).

**Autosetup Time:** Approximately 2 seconds.

**Vertical Find:** Automatically sets sensitivity and offset.

#### PROBES

##### Model:

One PP004 (10:1, 10 M $\Omega$  // 10 pF) probe supplied per channel. 200 V max input.

The 9370 series is fully compatible with LeCroy's range of FET Probes, which may be purchased separately.

**Probe calibration:** Max 1 V into 1 MW, 500 mV into 50 W, frequency and amplitude programmable, pulse or square wave selectable, rise and fall time 1 ns typical.

Alternatively, the Calibrator output can provide a trigger output or a PASS/FAIL test output.

#### INTERFACING

**Remote Control:** Possible by GPIB and RS-232-C for all front-panel controls, as well as all internal functions.

**RS-232-C Port:** Asynchronous up to 19200 baud for computer/terminal control or printer/plotter connection.

**GPIB Port:** (IEEE-488.1) Configurable as talker/listener for computer control and fast data transfer. Command Language complies with requirements of IEEE-488.2.

**Centronics Port:** Optional hardcopy parallel interface is provided with floppy and graphics printer options.

**Hardcopy:** Screen dumps are activated by a front-panel button or via remote control. TIFF and BMP formats are available for importing to Desktop Publishing programs. The following printers and plotters can be used to make hardcopies: HP DeskJet (color or BW), HP ThinkJet, QuietJet, LaserJet, PaintJet and EPSON printers; HP 7470 and 7550 plotters, or similar, and HPGL compatible plotters. An optional internal high resolution graphics printer is also available.

#### GENERAL

Auto-calibration ensures specified DC and timing accuracy.

##### Temperature:

5° to 40° C (41° to 104° F) rated 0° to 50° C (32° to 122° F) operating.

**Humidity:** <80%.

**Shock & Vibration:** Meets MIL-STD-810C modified to LeCroy design specifications and MIL-T-28800C.

**Power:** 90-250 V AC, 45-66 Hz, 230 W.

**Battery Backup:** Front-panel settings maintained for two years.

##### Dimensions:

(HWD) 8.5"x14.5"x16.25", 210mm x 370mm x 410mm.

**Weight:** 13 kg (28.6 lbs) net, 18.5 kg (40.7 lbs) shipping.

**Warranty:** Three years.

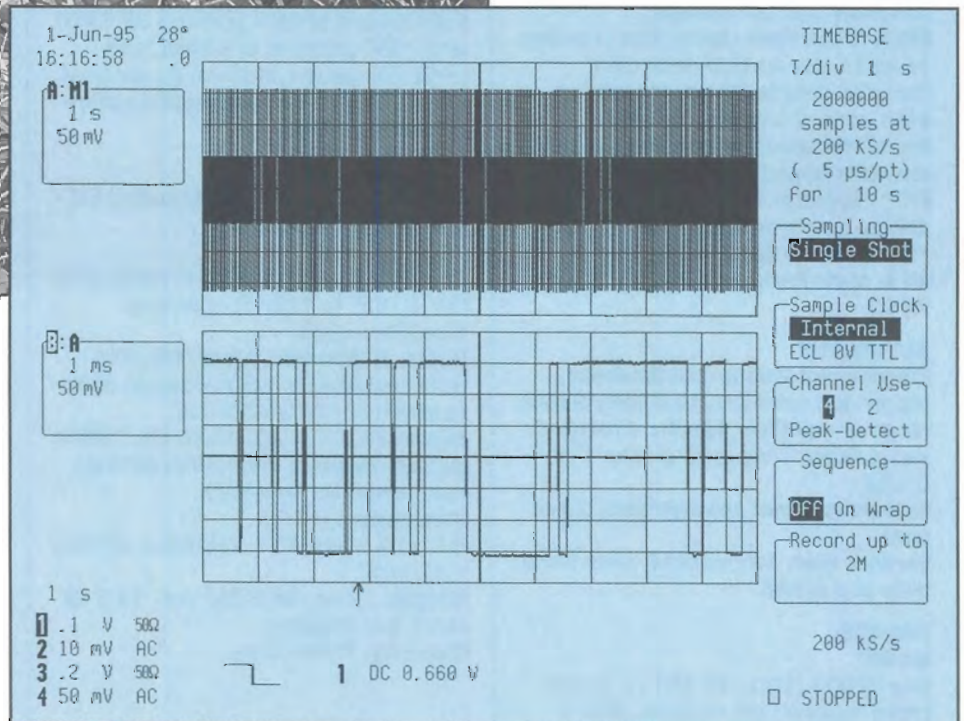
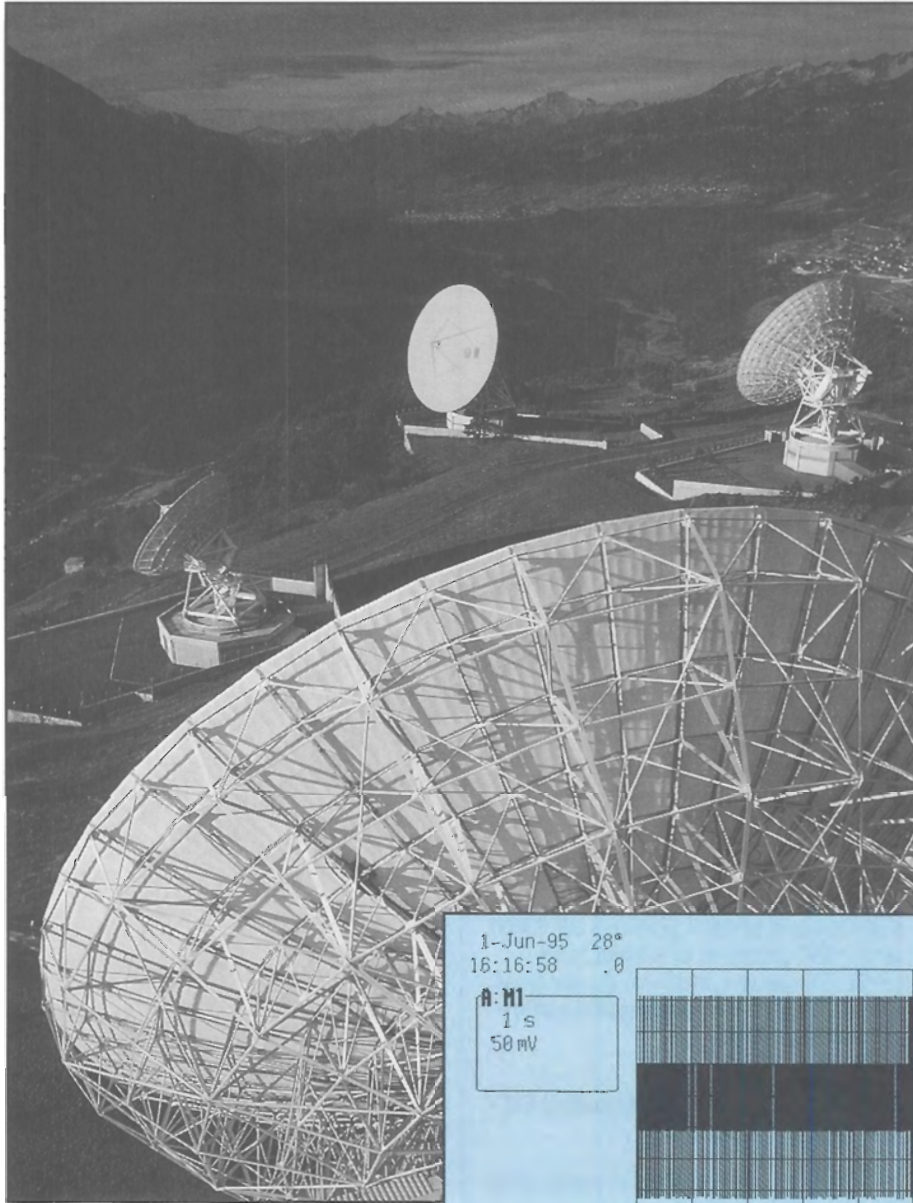

High bandwidth wireless communications signals can be captured best using the triggers, long memory and high bandwidth of the 9370 series. The signal above is 10 seconds (top trace) of data being transmitted to a pager. The zoom detail below shows individual 1's and 0's. For more information on testing communications signals refer to pages 161, 167 and 171.





9300 Series OEM Kits are available for system level designers who need a high performance front end for a test system or for some other form of signal analysis. Any 9300 series digital scope can be made available in kit form which removes the enclosure (including front panel) and display. The advantage of the OEM kit is that it provides a manufacturer the parts necessary to capture signals and perform first level analysis using a set of printed circuit boards and power supply that can be packaged inside an enclosure under the OEM's brand name and minimizes the space necessary for data acquisition.

Designers of integrated test systems frequently require a good front end stage with amplifier/attenuator, fast analog to digital conversion, high speed memory and a processor to compute answers or handle data transfer to a higher level processor. The 9300 series OEM kits provide these features beginning with BNC inputs for the signals through to IEEE-488 or RS-232 ports. The designer can create his own enclosure to optimize space utilization and air flow for cooling within the system.

#### **WHEN TO CONSIDER 9300 SERIES OEM KITS**

Designers of products as diverse as cable testing systems and time-of-flight mass spectrometers use LeCroy 9300 series OEM kits as the front end data acquisition for their product. Also, test engineers who

need to configure test sets used internally for their own manufacturing lines can choose to use OEM kits to save rack space. In both cases, acquiring LeCroy technology for data acquisition and fast first level analysis allows the product/test set to come to market much faster than designing it internally and the customer benefits from LeCroy's experience in fast data acquisition.

The choice of an OEM kit rather than purchase of a 9300 series digital scope should be made in cases where 25 or more systems will be manufactured with the same data acquisition requirement. Other considerations are the cost savings due to reduced space requirements, the ability to prevent the user from changing the test setup through the scope front panel (i.e. forcing the control interface to be through the OEM's computer software) and the ability to have a single brand name on the system. There is also a slight cost saving in purchase of OEM kits compared to the price of a complete oscilloscope. However the purchase of an OEM kit commits the engineer to design an enclosure and provide cooling which are included as standard features of the oscilloscope. In cases where only a few systems will be built, it is more cost effective to use a complete oscilloscope to avoid the difficulties and expense of designing an enclosure.

## **9300 OEM Kits**

### **Available for OEM System Designers**

- **High Speed Data Acquisition**
- **First Level Processing/Analysis Tools**
- **Variety of I/O ports**
- **Provides 9300 series performance in a compact package**

**SPECIFICATIONS**

The operating characteristics of a 9300 series OEM kit are the same as those of oscilloscope from which the kit is made except that all commands must be via remote control (there is no front panel). For example, the specifications of a 9304A-OEMkit are the same as for the 9304A digital oscilloscope. The designer needs to make sure appropriate shielding is placed between the data acquisition section of the OEM kit and any other electronics in the system that generate noise and that a fan is supplied to remove heat. Essentially, the electronic operating characteristics of the OEM kits are the same as for the scopes listed in this catalog but the physical characteristics (size and weight) are reduced.

**POWER SUPPLY**

The power supply provided with the 9300 Series OEM kits supplies +/- 5.2 volts and +/- 15.0 volts. There is an output adjustment range of approximately 5%. The output set point tolerance under maximum load is typically +/- 50 mv on the 5.2 volt supplies and 100 mv for the 15 volt supplies. Regulation is to within +/- 1% of nominal voltage on all outputs under all conditions of rated load, input voltage or frequency and operating temperature.

The input of the power supply is a 90-264 VAC universal input. The power supply will configure itself automatically for 115 or 230 VAC. Input frequency may be 45 to 440 Hz.

**ENVIRONMENTAL CHARACTERISTICS OF OEM KITS**

9300 Series OEM kits are designed to meet MIL-STD-810D procedures and MIL-T-28000C paragraph 4.5.5.4.2.

**High Temperature:** non operating, 48 hours at 40° C (104 F)  
operating, 2 hours at 50° C (122° F)

**Low Temperature:** non operating, 24 hours at -50° C (-58 F)  
operating, 2 hours at 0° C (32° F)

**Humidity:** to 75% at 50° C

**Vibration:** tested for "truck", "aircraft" and "military" test cycles.

**Shock:** 30 G's peak, duration 12 msec, 3 times non operating.

**PARTS INCLUDED**

**93XX motherboard:** 2 or 4 input channels with amplifier, sample and hold, ADC and acquisition memory

**93XX processor board:** either 16 MHz 68020/68881 or 32 MHz 68030/68882 with 4-16 Mbytes processing RAM (upgradable to 64 Mbytes)

**93XX I/O board:** Includes IEEE-488 (GPIB) and RS-232 ports

**Power Supply**

The exact part numbers of the PC boards and power supply vary depending on which OEM kit is desired. A variety of connection hardware is also supplied. Full parts list, mechanical drawings and schematics are available.



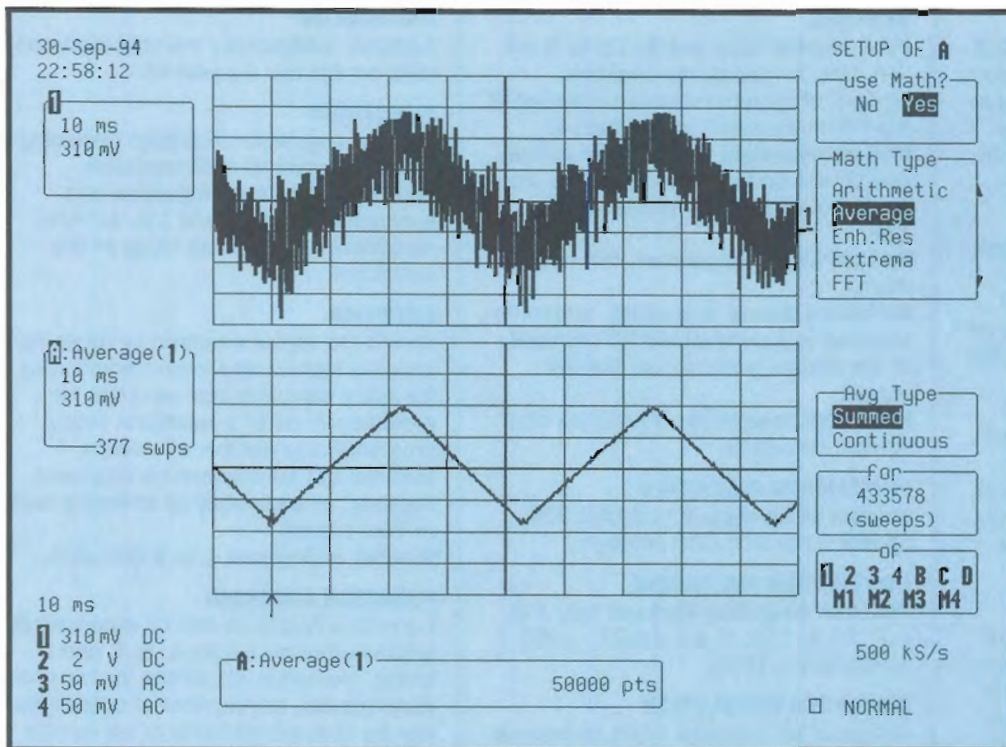

Summed Averaging is applied to the signal in Channel 1, to remove random noise. Trace A shows the result after 377 sweeps: the noise has practically disappeared.

The LeCroy WP01 Waveform Processing package features a powerful toolset that extends the processing power inside the 9300 oscilloscope, well beyond the capabilities of a traditional instrument.

In fact, all the processing is built-in to eliminate the need for external computers and controllers. High-speed microprocessors and up to 64 MBytes of RAM are used to ensure real-time updates of computed waveforms on the screen.

The package is fully programmable over GPIB or RS-232-C interfaces, and hard copies can be made directly on to a wide range of printers (including the optional internal printer), plotters or graphic formats. Data can also be saved to optional floppy disk and PCMCIA portable hard drive.

## Features and Benefits

### EXTENSIVE SIGNAL AVERAGING

WP01 offers two powerful, high-speed averaging modes that can be used to reduce noise and improve the signal-to-noise ratio. Vertical resolution can be extended by several bits to improve dynamic range and increase the overall input sensitivity to as much as 50 mV/div.

**Summed averaging**, where up to 1,000,000 sweeps are repeatedly summed, with equal weight, in a 32-bit

accumulation buffer for improved accuracy. The accumulated result is then divided by the number of sweeps.

**Continuous/exponential averaging** where a weighted addition of successive waveforms can be performed with weighting factors from 1:1 to 1:1023. The averaging goes on indefinitely with the contribution of "older" sweeps gradually decreasing. The method is particularly appropriate to reduce noise on signals drifting very slowly in time or amplitude.

### ENHANCED RESOLUTION BY DIGITAL FILTERING

Allows low-pass F.I.R. filtering of the digitized signals, with 6 different cutoff frequencies per sampling rate setting. As a result, the vertical resolution of the captured signals – single-shot or repetitive – increases from 8 bits to 11 bits in 0.5-bit steps. This feature is ideal to strip off unwanted high-frequency noise on transient events.

### RESCALING

Allows an input signal to be rescaled using a  $(ax + b)$  correction factor to compensate for gain and offset. This is very useful when dealing with various types of transducers, to read the correct temperature or pressure value directly from the scope's cursor.

## WP01 Waveform Processing Package for the 9300 Family of Digital Oscilloscopes

### Main Features

- High-precision averaging up to 1 million sweeps
- Extended digital filtering capabilities
- Rescale function, with  $(ax + b)$  correction factor
- Envelope mode
- Integration
- Differentiation
- Log(e) and Log(10)
- Exp(e) and Exp(10)
- Absolute Value, Reciprocal
- Square, Square root
- Powerful function chaining feature



**ENVELOPE MODE**

Shows the signal envelope by retaining only the highest and lowest amplitudes for every sampling interval, over a user-definable number of sweeps. Ideal to visualize the time or amplitude jitter in a signal.

**POWERFUL MATH TOOLSET**

In addition to the basic arithmetic functions found in the standard models (+, -,  $\leftrightarrow$ ,  $\cdot$ ,  $\div$ ), WPO1 adds an impressive set of functions such as integration, differentiation, logarithms and exponential – in both bases 10 and e – square, square root, reciprocal and absolute value. All these functions are updated automatically each time a new waveform is acquired, showing a “live” representation of a computed trace. This would be impossible to achieve on a separate computer.

**FUNCTION CHAINING**

When more than one math function is needed in the equation, WPO1 supports function chaining, and allows the user to multiply, for instance, the “Voltage” and the “Current” channel and to integrate the result to get an instantaneous energy curve.

**REMOTE CONTROL**

All of the waveform processing can be controlled via GPIB or RS-232-C remote control. And the function traces do not even need to be called up on screen to be updated, an important feature that speeds up the computation.

**GENERAL**

**Max. number data points:** Up to 8 million. Only limited by the available amount of system memory (indicated in the “memory used” status menu).

**Min. number data points:** Data points can be reduced down to 50 in the processing function to improve update rate.

**Vertical Zoom:** supported, 50 $\times$  maximum.

**Horizontal Zoom:** supported, maximum zooming to a point where 50 samples of the source trace occupy the full screen.

**Maximum Sensitivity:** 50 mV/div after vertical expansion.

**SUMMATION AVERAGING**

**Number of Sweeps:** 1 to 1,000,000.

**Speed:** up to 200,000 points/s.

**CONTINUOUS AVERAGING**

**Possible Weighting Factors:** 1:1, 1:3, 1:7, 1:15, 1:31, 1:63, 1:127, 1:255, 1:511 and 1:1023.

**ENHANCED RESOLUTION**

Choice of six low-pass filters to improve vertical resolution improvement from 8 to 11 bits in 0.5-bit steps.

**Resulting bandwidth:**

0.5 bit	0.5 $\leftrightarrow$ Nyquist BW
1 bit	0.241 $\leftrightarrow$ Nyquist BW
1.5 bit	0.058 $\leftrightarrow$ Nyquist BW
2 bit	0.029 $\leftrightarrow$ Nyquist BW
2.5 bit	0.016 $\leftrightarrow$ Nyquist BW

Nyquist BW = 1/2  $\leftrightarrow$  sample frequency.  
Rescale ax + b rescaling with a and b ranging from  $\pm 0.00001$  E-15 to  $\pm 9.99999$  E+15

**ARITHMETIC**

Addition, subtraction, multiplication and ratio on any two waveforms.

**FUNCTIONS**

Identity, negation, integration (including additive constant), differentiation, square, square root, logarithm and exponential (base e and 10), sin x/x, reciprocal and absolute value of any waveform.

**EXTREMA**

Shows the signal envelope by retaining only the highest and lowest amplitudes for every sampling interval. Logs all extreme values of a waveform over a programmable number of sweeps. Maxima and minima can be displayed together, or separately by choosing roof or floor traces.

**Number of Sweeps:** 1 to 1,000,000.

**FUNCTION CHAINING**

Up to four functions can be automatically chained using traces A, B, C and D. Using memories M1 to M4 for intermediate results, any number of operations can be chained manually or via remote control.

**REMOTE CONTROL**

All controls and waveform processing functions are fully programmable using simple commands over the oscilloscope's GPIB or RS-232-C interfaces.

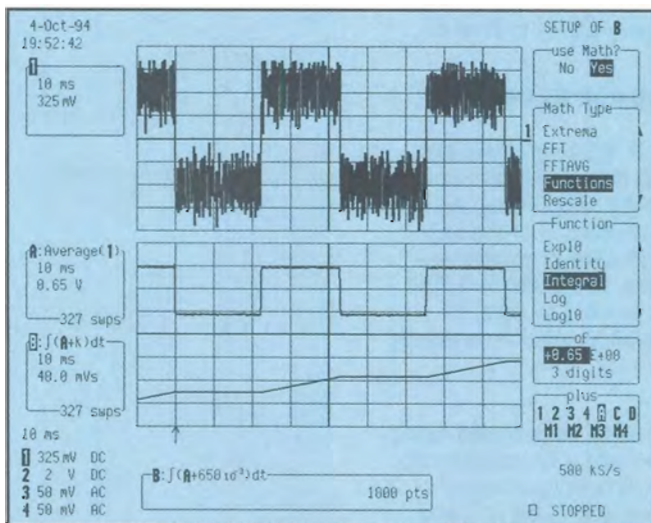

To illustrate WPO1's function chaining ability, the noisy signal in Channel 1 has been averaged in Trace A to remove undesired noise, and the result integrated in trace B.

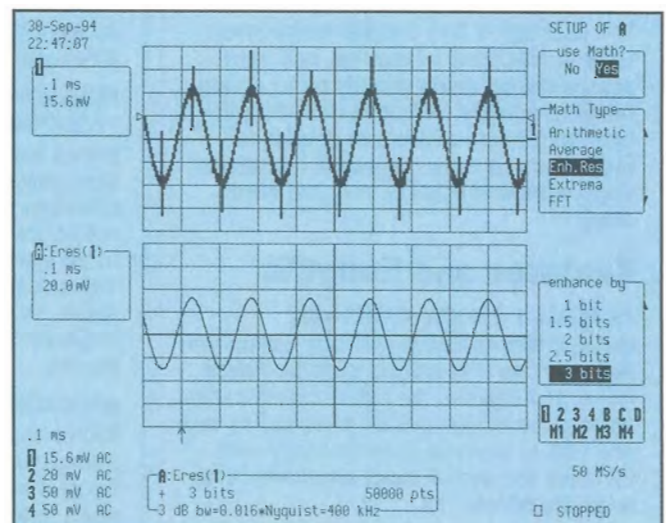

High-frequency glitches in Channel 1 have been dramatically reduced in Trace A by using the low-pass filtering properties of the Enhanced Resolution Function.



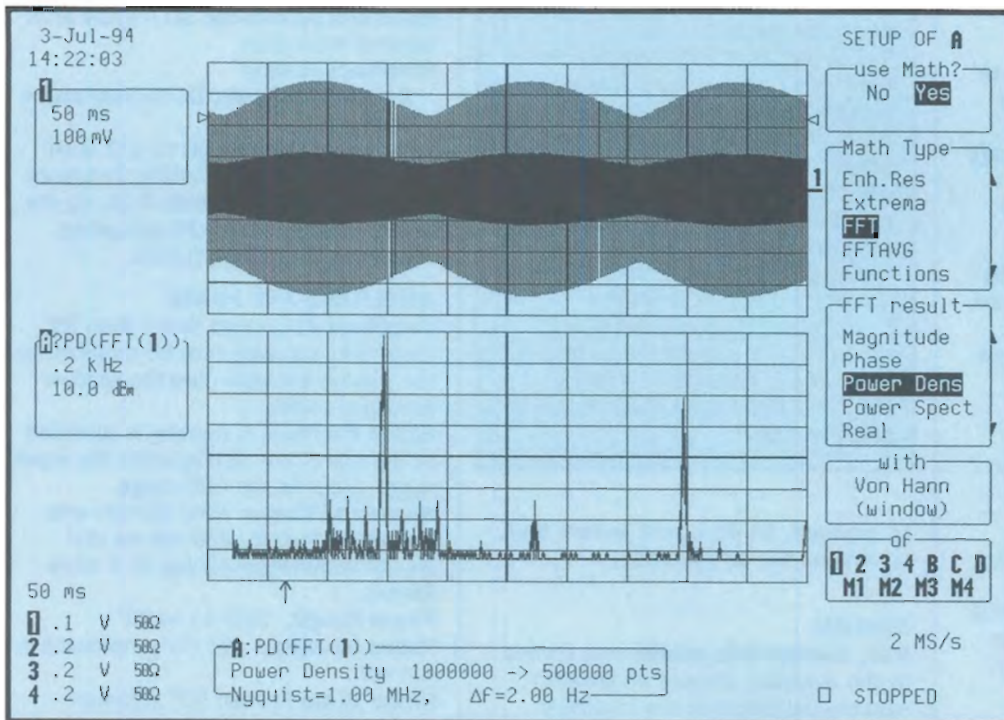

The WPO2 Spectrum Analysis package provides the 9300 oscilloscope with a powerful frequency-domain toolset that extends its processing capabilities, well beyond the realm of a standard instrument. In fact, all the processing is built-in to eliminate the need for external computers and controllers.

High-speed microprocessors and up to 64 MBytes of RAM are used to perform computations. Fast Fourier Transforms (FFTs) convert time domain waveforms into frequency domain records to reveal valuable spectral information such as phase, magnitude and power. The package is fully programmable over GPIB and RS-232-C interfaces, and hardcopies can be made directly on to a wide range of printers (including the optional internal printer), plotters or graphic formats. Data can also be saved to optional floppy disk or PCMCIA portable hard drive.

## Features and Benefits

### WHY FFT IN A SCOPE?

The FFT package on a LeCroy 9300 has at least four clear advantages over common swept spectrum analyzers:

- It can show the spectrum of a **transient signal**.
- Both **time and frequency** information can be monitored **simultaneously**.
- Phase information is **available**.
- The price is **attractive**.

It has two definite advantages over FFT analyzers:

- It can show higher-frequency components.
- Both **time and frequency** information can be monitored **simultaneously**.
- The price is **attractive**.

### BROAD SPECTRUM COVERAGE

The frequency spectrum ranges from DC to the full bandwidth of the oscilloscope for repetitive signals, and to one half of the maximum sampling frequency for transients.

### MULTI-CHANNEL ANALYSIS

All input channels can be analyzed simultaneously to look for common frequency-domain characteristics in independent signals.

### VERSATILE SCALING FORMATS

Frequency-domain data may be presented as magnitude, phase, real, imaginary, complex, log-power and log-PSD (Power Spectral Density).

### STANDARD WINDOW FUNCTIONS

Use rectangular for transient signals; von Hann (Hanning) and Hamming for continuous waveform data; Flattop for accurate amplitude measurements; Blackman-Harris for maximum frequency resolution.

### FREQUENCY DOMAIN AVERAGING

Up to 50,000 FFT sweeps may be averaged to reduce base-line noise, enable analysis of phase-incoherent signals or signals which cannot be triggered on.

## WPO2 Spectrum Analysis Package for the 9300 Family of Digital Oscilloscopes

### Main Features

- Frequency range from DC up to the instrument's full bandwidth
- Simultaneous FFTs on up to 4 channels
- Perform FFT on up to 6 million time domain samples
- Frequency resolution down to 100  $\mu$ Hz
- Frequency domain averaging
- Wide selection of scaling formats and window functions
- 5 window functions
- Up to 5 1000-point FFTs per second
- Full support of cursors and automatic waveform parameters
- Full PASS/FAIL testing support



### FREQUENCY CURSORS AND WAVEFORM PARAMETERS

Cursors can be set on the FFT trace to show up to 0.004% frequency resolution (up to 0.002% for 10,000 point memory) and measure power or voltage differences to 0.2% of full scale. Automatic waveform parameters can also be applied to FFT traces.

### PASS/FAIL TESTING ON FFT TRACES

PASS/FAIL testing is fully supported on FFT traces. The instrument can be setup to test incoming spectra against tolerance masks. In case the signal "fails", the instrument can be programmed to perform a choice of actions (screen dump, waveform storage, pulse out, etc.)

### RESCALING

Allows an input signal to be rescaled using a (ax + b) correction factor to compensate for gain and offset. This is very useful when dealing with various types of transducers, to read the correct temperature or pressure value directly from the scope's cursor.

### FUNCTION CHAINING

When more than one math function is needed in the equation, WPO2 supports function chaining, and allows the user to multiply, for instance, the "Voltage" and the "Current" channel and to integrate the result to get an instantaneous energy curve.

### REMOTE CONTROL

All of the waveform processing can be controlled via GPIB or RS-232-C remote control. And the function traces do not even need to be called up on screen to

### FOURIER PROCESSING

Fourier processing is a mathematical technique which enables a time-domain waveform to be described in terms of frequency-domain magnitude and phase, or real and imaginary spectra. It is used, for example, in spectral analysis where a waveform is sampled and digitized, then transformed by a Discrete Fourier Transform (DFT). Fast Fourier Transforms (FFT) are a set of algorithms used to reduce the computation time (by better than a factor of 100 for a 1000 point FFT) needed to evaluate a DFT.

be updated, an important feature that speeds up the computation.

### GENERAL

**Max. number data points:** only limited by the available amount of system memory (indicated in the "memory used" status menu). Up to 6 million data points can be handled in scopes equipped with the 930X-64 RAM option of 64 MBytes of RAM.

**Min. number data points:** Data points can be reduced down to 50 in the processing function to improve update rate.

**Vertical Zoom:** supported, 50 $\leftrightarrow$  maximum.

**Horizontal Zoom:** supported, maximum zooming to a point where 50 samples of the source trace occupy the full screen.

**Maximum Sensitivity:** 50 mV/div after vertical expansion.

**Frequency Range:**

**Repetitive signals:** DC to instrument bandwidth.

**Transient signals:** DC to 1/2 maximum single-shot sampling frequency

**Frequency Scale Factors:** 0.05 Hz/div to 0.2 GHz/div in a 1-2-5 sequence.

**Frequency Accuracy:** 0.01%.

### AMPLITUDE AND PHASE

**Amplitude Accuracy:** Better than 2%. Amplitude accuracy may be modified by the window function (see the window functions table).

**Signal Overflow:** A warning is provided at the top of the display when the input signal exceeds the ADC range.

**Number of Traces:** Time domain and frequency domain data can be displayed simultaneously (up to 4 waveforms).

**Phase Range:** -180° to +180°.

**Phase Accuracy:**  $\pm 5^\circ$  (for amplitudes > 1.4 div).

**Phase Scale Factor:** 50° /division.

spectrum scaling formats

**Horizontal Scale:** Linear, in Hz

**Vertical Scales:**

**Power Spectrum** in dBm (1 mW into 50 W).

**Power Spectral Density (PSD)** in dBm.

**Magnitude, Real, Imaginary:** Linear, in V/div

**Phase Display:** Linear, in degrees.

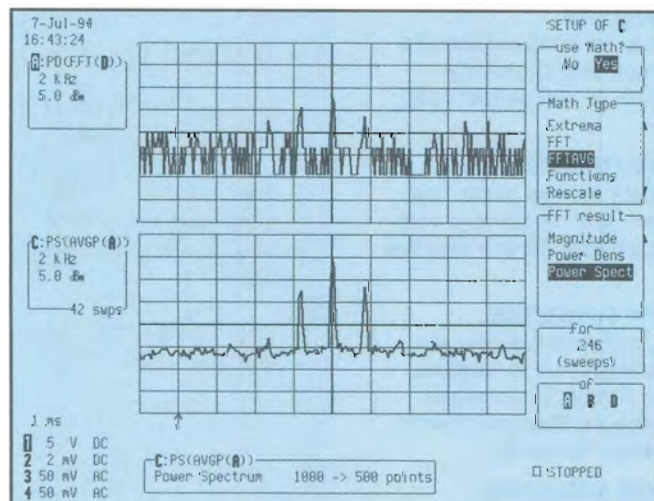

An FFT (top trace) with spectral components buried in noise. By applying the power averaging function (lower trace), all the baseline noise is removed, and the spectral components of an AM signal are clearly visible.

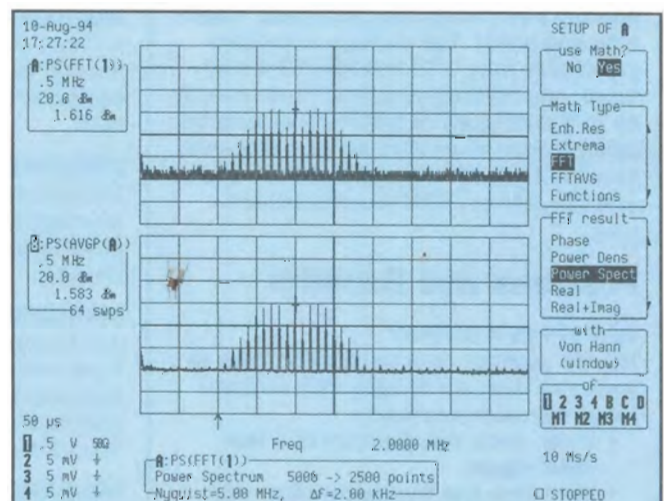

Frequency modulated signal, 2 MHz carrier with 99 kHz modulation frequency, 4:1 frequency deviation, FFT shows modulation sidebands, FFT power average used to improve s/n ratio.



### WINDOW FUNCTIONS

Rectangular, von Hann (Hanning), Hamming, Flattop and Blackman-Harris (see table below).

fft execution times\*

100 points in less than 0.03 s.

1000 points in less than 0.3 s.

10000 points in less than 3 s.

\* Only valid for 9350, 9360, 9370 and 9304/10 with MWP option. Other models, add 50%

### FREQUENCY DOMAIN POWER AVERAGING

Summation averaging of power, PSD or magnitude for up to 50,000 sweeps.

### FUNCTION CHAINING

Up to four functions can be automatically chained using traces A, B, C and D. Using memories M1 to M4 for intermediate results, any number of operations can be chained manually or via remote control.

### REMOTE CONTROL

All controls and waveform processing functions are fully programmable using simple commands over the oscilloscope's GPIB or RS-232-C interfaces.

Adding the WP02 Spectrum Analysis Package to the 9300 family of digital oscilloscopes provides a fast and economical solution to frequency domain applications.

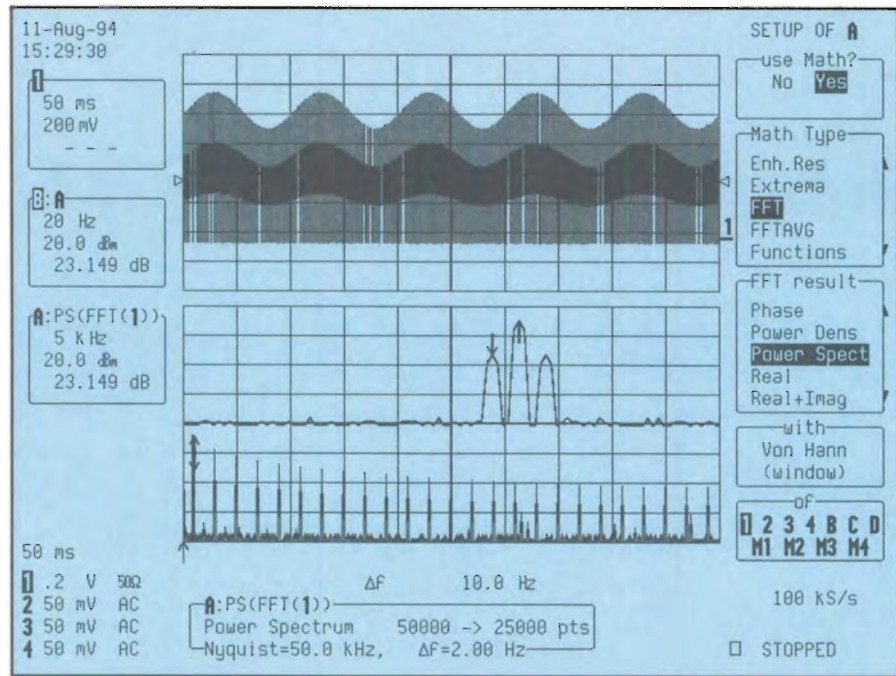

FFT analysis of a 1 kHz square wave with 25% pulse amplitude modulation at 10 Hz. Long memory and 50 kpoint FFT show up to 51st harmonic, while expansion shows 10 Hz modulation sidebands.

Filter Pass Band and Resolution				
Window Type	Filter bandwidth at -6dB [freq. bins]	Highest side lobe [dB]	Scallop loss [dB]	Noise bandwidth [freq. bins]
Rectangular	1.21	-13	3.92	1
von Hann	2	-32	1.42	1.5
Hamming	1.81	-43	1.78	1.36
Flattop	1.78	-44	0.01	2.96
Blackman-Harris	1.81	-67	1.13	1.71

Filter Bandwidth at -6dB characterizes the frequency resolution of the filter.  
 Highest Side Lobe indicates the reduction in leakage of signal components into neighboring frequency bins.  
 Scallop Loss is the loss associated with picket fence effect.

This page left intentionally blank.



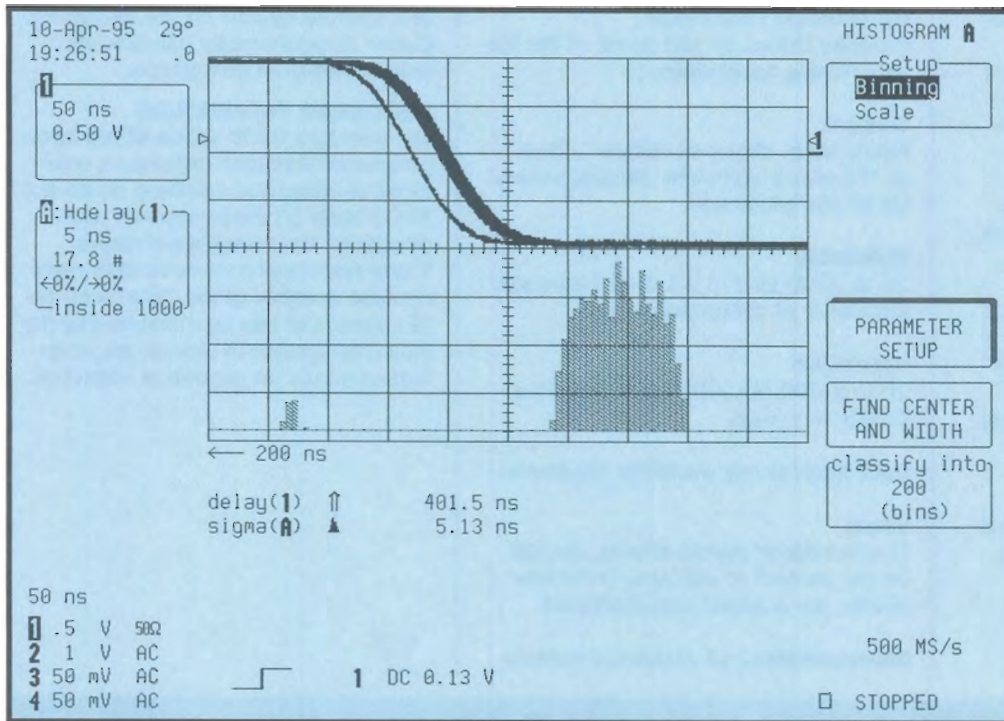

The LeCroy WPO3 Waveform Processing package extends the measurement capability of the 9300 oscilloscope by providing a new processing function – built into the oscilloscope – to perform in-depth analysis on waveform parameters – a task that was formerly carried out either manually, with a notepad, or by means of an external computer, in a spreadsheet program.

The new function provides **histogramming** of any waveform parameter measurement, and can be conveniently **autoscaled** to display the center and width of the distribution. In addition, an already wide range of automated measurements are extended to provide a new category of statistical measurements specifically designed to analyze histogram distributions.

The package is fully programmable over GPIB and RS-232-C interfaces, and hardcopies can be made directly to a wide range of printers (including the optional internal printer), plotters or graphic formats.

#### WAVEFORM PARAMETER ANALYSIS

WPO3 adds a powerful dimension to waveform analysis by recording and analyzing

the properties of a series of waveform parameter measurements. This is accomplished by a function that records the parameter values and presents the data in a statistical form – the Histogram.

The Histogram function produces a waveform consisting of one point for each histogram bin, where the value of each point is equal to the number of parameter values which fall into the corresponding bin. Analysis of histogram distributions is supported by a wide range of automated statistical parameters, which provide insight and quantitative analysis into difficult-to-measure phenomena such as jitter and amplitude fluctuation. This function is also invaluable in establishing production test limits.

#### A DATABASE IN THE OSCILLOSCOPE

The Histogram function performs calculations on a stored history database of waveform parameters. This allows detailed analysis to be performed on parameter data without the need to reacquire the source waveforms. Having the parameter database available also allows automatic scaling of histogram and graph displays.

## WPO3 Parameter Analysis Package for the 9300 Family of Digital Oscilloscopes

### Main Features

- Histogram function for over 40 different parameters
- Up to 2000 bins
- Population of up to 2,000,000,000
- 18 histogram parameters
- Autoscale on Histogram
- Histograms of all or individual segments in sequence waveforms



**WAVEFORM PARAMETER MEASUREMENTS**

The LeCroy 9300 series has the capability to perform a wide range of automated waveform parameter measurements which make interpretation of waveform data easy, accurate and repeatable. The distribution of these parameter measurements can be analyzed by histogramming their values. Some of the waveform parameters available include:

amplitude	Δt at level (abs)	overshoot+
area	Δt at level (%)	overshoot -
base	duty cycle	peak to peak
cmean	falltime	period
cmedian	f80-20%	risetime
crms	f@level (abs)	r20-80%
csdev	f@level (%)	r@level (abs)
cycles	frequency	r@level (%)
delay	maximum	RMS
Δdelay	mean	std dev
median	top	minimum
width		

**HISTOGRAM FEATURES**

Provided below are just some of the histogramming capabilities.

**Vertical:**

Autoscaling, choice of "Linear", "Log" or "Constant maximum" (linear) scales. Up to 50x expansion.

**Horizontal:**

20 to 2000 bins in a 1-2-5 sequence. Autoseup of center and width.

**Population:**

20 to 2,000,000,000 selectable in a 1-2-5 sequence.

**Data Source:** Any waveform parameter.

**Value:**

The number of events binned, as well as the percent of overflow/underflow events are automatically displayed.

**Measurements:** 18 Statistical parameters

operate directly on the histogram. Cursor measurements can also be made directly on histograms.

**HISTOGRAM PARAMETERS**

The standard 9300 series offers basic parameter statistics (maximum, minimum, average and standard deviation). WPO3 adds 18 Parameters for use directly on the histogram displays. These additional measurements allow detailed analysis of the parameter distributions and can be monitored by the pass/fail system to provide go/no-go testing based on parameter statistics.

**Histogram Parameters**

Parameter	Abbreviation	Explanation
histogram base	hbase	Horizontal position of left-most statistically significant bin.
histogram top	htop	Horizontal position of right-most statistically significant bin.
histogram amplitude	hampl	Horizontal difference between the htop and hbase values.
histogram rms value	hrms	Root Mean Square value of histogram distribution
sigma	sigma	Standard Deviation of histogram distribution
low	low	Horizontal position of left-most non-zero bin.
high	high	Horizontal position of right-most non-zero bin.
range	range	Horizontal difference between the high and low values.
total population	totp	Total population in the histogram.
maximum population	maxp	Maximum population in any histogram bin (i.e. vertical value at the mode).
peaks	pks	Number of peaks in the distribution.
mode	mode	Horizontal position of the bin with the maximum population.
average	avg	Horizontal mean of the distribution.
median	median	Horizontal median of distribution. The value of the mid-point of the distribution.
full width at half max	fwhm	The width of the distribution around the maximum population bin, including bins which contain at least one half of the maximum population.
full width at x% of max	fwxx	The width of the distribution around the maximum population bin, including bins which are at least x% of the maximum population.
x position at peak	xapk	Horizontal position of the nth largest peak by area.
percentile	pctl	Value in histograms for which % of population is smaller.



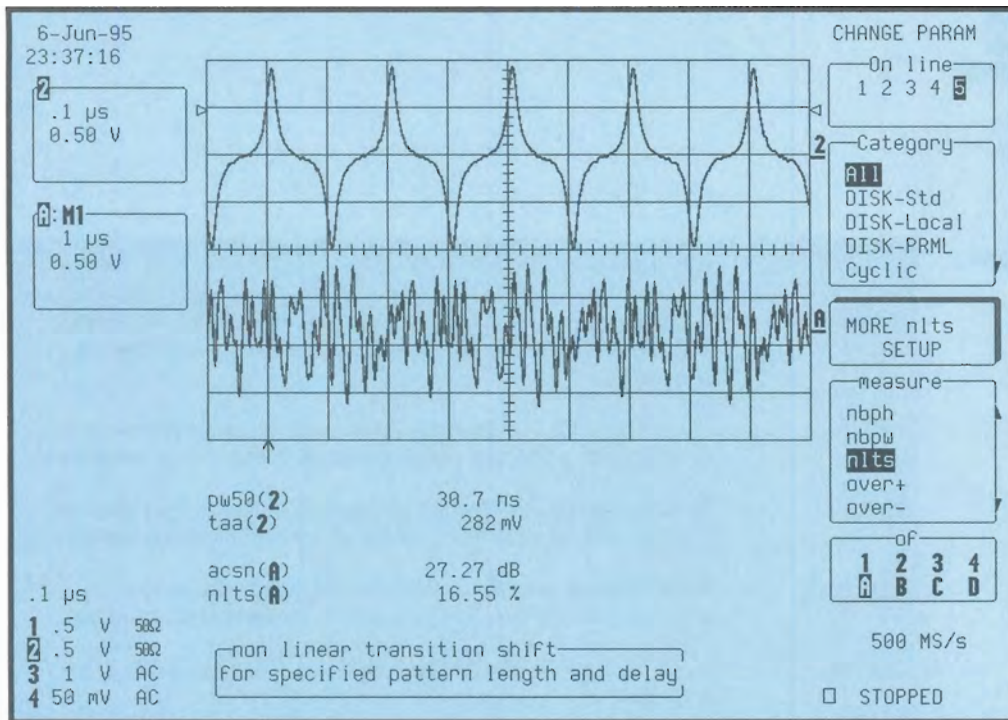

#### DISK DRIVE SOFTWARE PACKAGES

The Disk Drive Measurement and PRML Measurement Packages utilize IDEMA® test methods and industry standard PRML measurements to extend the range of capabilities of the LeCroy Model 9300 series of Digital Oscilloscopes to provide in-depth analysis of disk drive performance.

Combine the 9354's 500 MHz analog bandwidth (or the 9370's 1 GHz bandwidth), 2 GS/s maximum sample rate, 2 MByte record length per channel (combinable to 8 MBytes), sequence triggering, and Smart Trigger™ operation with these new disk drive analysis packages any you have the perfect solution to complete disk drive analysis and testing.

Now you can make your standard disk drive measurements and PRML measurements with your LeCroy 9300 series scope and view the results on screen. Both packages are fully programmable over GPIB or RS-232.

## 9300 Family Disk Drive Software Packages

- **Disk Drive Parameters**

Pulse Width 50  
Track Average  
Amplitude  
Resolution  
Overwrite

- **PRML Measurements Non Linear**

Transition Shift  
Auto-Correlation  
Signal-to-Noise  
Auto Correlation

- **Feature Analysis Parameters including**

Local time between peaks  
Local time between troughs  
Local time over threshold  
And ten others...

- **Statistical processing Functions**

Histograms provide bar charts for easy analysis of measurement results over many events.

**DISK DRIVE PARAMETERS PACKAGE**

The Disk Drive Measurement package includes processing functions specified in the International Disk Drive Equipment and Materials Association (IDEMA®) test standards document\*. These include:

Disk Drive Measurements of Pulse Width, Track Amplitude, Resolution and Overwrite

Feature Analysis Parameters

Narrow Band Frequency Domain Parameters

Statistical Parameters

Statistical Processing Functions

Name	Description
PW50*(1)	Pulse Width 50: Provides an average pulse width, measured at 50% peak amplitude, of all peak/trough pairs in the specified waveform.
PW50(+)	Pulse Width 50 (+): Provides an average pulse width, measured at 50% peak amplitude, of all peaks in the specified waveform.
PW50 (-)	Pulse Width 50 (-): Provides an average pulse width, measured at 50% peak amplitude, of all troughs in the specified waveform.
TAA ±*(2)	Track Average Amplitude: Provides an average peak-to-peak amplitude of all Peak/Trough pairs in the specified waveform.
TAA (+)	Track Average Amplitude (+): Provides an average peak amplitude of all peaks in the specified waveform.
TAA (-)	Track Average Amplitude (-): Provides an average peak amplitude of all troughs in the specified waveform.
RESOLUTION*(3)	Specified as $(TAA(F1)/TAA(F2))*100\%$ Where: F1 = Low Frequency F2 = High Frequency
OW*(4)	Overwrite: Specified as: $10 \log (V_r/V_o)$ Where: $V_r$ if the residual $V_{rms}$ of F1 (low frequency) after F2(high frequency) write $V_o$ is the $V_{rms}$ of F1 (low frequency) after F1 write.

**FEATURE ANALYSIS PARAMETERS**

Parameters that provide for analysis of amplitude and timing relationships between features (peak/trough pairs) of a waveform are also included in the Disk Drive Measurement Package. Used in conjunction with the Histogram processing function a statistical description of the waveform can be calculated.

lmax	local maximum
lmin	local minimum
lnum	number of local peak and trough pairs
lpp	local peak to peak (lmax - lmin)
ltbe peak)	local time between events (either peak to trough or trough to peak)
ltbp	local time between peaks
ltbt	local time between troughs
ltmn	local time at minimum
ltmx	local time at maximum
ltot	local time over threshold
ltpt	local time between peak and trough
lttp	local time between trough and peak
ptut	local time under threshold

\*As specified in IDEMA Standards. 1994 Revised Edition

(1) Document No. T15-91

(2) Document No. T3-91

(3) Document No. T4-91

(4) Document No. T14-91



**FREQUENCY DOMAIN PARAMETERS DESCRIPTION**

These parameters provide a rapid technique to extract the amplitude and phase of single frequencies from complex waveforms. These parameters are more efficient than using an FFT if the frequencies of interest are known.

Name	Description
nbph	narrow-band phase in degrees relative to start of waveform
nbpw	narrow-band power in dBv

**Histograms:**

Any waveform parameter may be histogrammed. The histogram function produces a waveform with the vertical axis in units of "Events" and the horizontal axis in parameter units (volts, nanoseconds, ...etc.). The histogram shows the statistical variation of the selected parameter.

**STATISTICAL PARAMETERS FEATURES DESCRIPTION**

These parameters are used in conjunction with histograms to allow for easy interpretation of the results.

Name	Description
Low	minimum value
High	Maximum value
Range	High - Low
FWHM	Full Width Half Max
Maxp	Maximum Population is the highest population (vertical value) in the histogram
Average	Mean value
Sigma	Standard deviation
Tpop	Total Population
XAPK	Provides the horizontal position of the selected peak
Pks	Provides the total number of peaks
Median	Provides the horizontal position of the value which divides the histogram into two equal populations
Mode	Provides the horizontal position of the most frequently occurring value
Percentile	Provides the horizontal position of the peak which separated the histogram such that the population on its left is a specified percentage on the total.

## PRML Measurement Package

### PRML PARAMETERS

PRML (Partial Response Maximum Likelihood) recording channels provide higher areal densities by allowing magnetic transitions to be written at closer spacing than peak detection channels. The following parameters provide a time domain technique to measure the time shift and S/N ratio created by this magnetic writing process.

### PRML MEASUREMENT PACKAGE

Includes the following functions:

- Non Linear Transition Shift
- Auto Correlated Signal to Noise
- Auto Correlation

Name	Description
NLBS	non-Linear Bit (or Transition) Shift: $NLBS = -2 * r$ Where $r$ = auto correlation coefficient @ time delay
ACSN	Auto Correlation Signal to Noise Ratio: $ACSN = 10 \log (R/1-R)$ Where $R$ = correlation coefficient
AutoCorrelation	$R_x(u) = \int f_x(t)f_x(t-u)dt$





## 9300 Series PCMCIA Hard Disk Adapter, Internal Printer, 3.5" Floppy Disk Drive & Ram Card

### Main Features

- PCMCIA Type III compatible Portable Hard Drive Adapter, DOS Compatible
- High-resolution Printer, ideal for fast, on-the-spot documentation
- 3.5" Floppy disk drive, DOS format - affordable and convenient
- Ultra-fast RAM card, DOS format, ideal for PASS/FAIL testing
- Convenient Hardcopy storage to Memory Card, Floppy Disk or Portable Hard Drive

### 3.5" FLOPPY

The floppy drive is a convenient storage medium, not only for saving and retrieving waveforms or instrument settings, but also for storing hardcopies that can be printed from a PC when desired. The floppy supports both 720k and 1.44M DOS formats so that it can be read back on any PC with a 3.5" drive, avoiding the need to interface the oscilloscope to your PC. As with the RAM-card option, the floppy system capabilities include automatic storage of data under pre-programmed conditions.

### PCMCIA STORAGE

PCMCIA Interfaces for RAM card and portable hard drive allow the use of fast, removable and compact storage media for saving and retrieving waveforms and instrument settings. They comply fully with the PC industry's PCMCIA and JEIDA standards. With the special Autostore feature, waveforms can be automatically stored

after every acquisition and "played back" when desired. When used in combination with the PASS/FAIL feature, failure data can be saved automatically for later analysis.

### PRINTER

The internal printer is an invaluable tool for instant, on-the-spot documentation. It generates a clear, crisp hardcopy of the screen in just a few seconds. The large size of the printout, combined with its high resolution, provide you with an excellent document that matches the screen's superior quality to its finest details. And because it frees you from the trouble of carrying and interfacing a bulky printer, it is the ideal solution for field measurements.

The printer also has a landscape mode which allows the printout to be expanded (up to 200 times) for full viewing of all signal details.

## Mass Storage Features and Benefits

LeCroy's mass storage capabilities provide a range of benefits:

- Easy data transfers to PCs
- Waveform logging
- Waveform archiving for future use
- Faster troubleshooting
- Faster, more reproducible testing
- Shared oscilloscope resources

### EASY DATA TRANSFER TO PC

Because the 9300 series oscilloscope uses DOS-formatted floppy disks, hard disks and memory cards, transferring waveform data to a PC is simple. The removable storage allows transfers without cables, programming, or any knowledge of GPIB, RS-232, or other interfaces.

In addition, LeCroy provides free of charge, a binary-to-ASCII format conversion program for the PC, accommodating those PC-based analysis packages (such as spreadsheets) that require ASCII format.

### WAVEFORM LOGGING

By using Glitch or Dropout triggering in combination with the powerful AUTO-STORE mode, LeCroy oscilloscopes can monitor and log intermittent problems automatically. To store a waveform, the oscilloscope opens and names a DOS-compatible file and then stores the waveform data in the file.

This logging feature requires no operator intervention and maintains data and the operational setup through power line failures. Logged waveforms can be selectively played back by trigger time/date or by sequence number, or can be scrolled through sequentially.

### WAVEFORM ARCHIVING FOR FUTURE USE

- Recallable proof of performance
- Additional data analysis as needed
- Accurate trend or drift monitoring
- Calibration procedure verification

When storing waveforms, LeCroy DSOs also archive a header of setup information and the acquisition time/date.

After recalling an archived waveform, the several hundred byte header ensures correct time and voltage scaling. When recalled into the oscilloscope, the waveform can be zoom expanded, compared, or analyzed just like a live waveform. The time/date offers proof of measurement authenticity and trend sequence.

All LeCroy DSOs store raw waveform data using one byte per sample point. Signal averaged, Enhanced Resolution (ERES) filtered, and other processed

data use two bytes per point, to take advantage of the added resolution.

### HARDCOPY ARCHIVING

Hardcopies of the screen can also be stored for future use. For instance, a screen saved in TIFF format can be imported into a Word Processor to illustrate a report. Additionally, field-measurement screens can be saved in LaserJet format on the memory card or floppy disk, and then printed from a PC back in the lab.

### FASTER FIELD MEASUREMENTS

Recallable reference waveforms and oscilloscope setups for each test point on a Device Under Test (DUT) can make fault troubleshooting faster and more accurate. A dedicated memory card or floppy disk will hold all of the correct test point waveforms and associated DSO setups for a particular DUT.

The technician can recall stored setups quickly and consistently, thereby avoiding incorrect measurement conditions. He can then compare actual waveforms to recalled reference waveforms taken from a known working system. He will therefore spend less time probing a large number of test points and verifying that the correct waveforms exist. If a problem is found, the aberrant waveform may be saved. It can later be shown to laboratory-based engineers, for example, for problem-solving guidance or for improvement of DUT design. Memory cards - rugged and pocket-sized - are ideal for this application.

### FASTER, MORE REPRODUCIBLE TESTING

LeCroy oscilloscopes will compare measured waveforms against upper and lower waveshape tolerances or against parameter limits, such as risetime, overshoot, or peak voltage, and make PASS/FAIL decisions. This PASS/FAIL testing decreases test times in GPIB-based ATE systems by reducing data transfers. It increases reproducibility and accuracy in manual tests by eliminating human errors.

Once defined, these tests may be saved by storing instrument setups which include the specified tolerances and/or reference waveforms. Different test personnel can easily share a common test library via a PC network. Waveshape test limits can be generated by capturing a "golden" waveform and by then selecting amplitude and timing limits (in fractions of screen graticule divisions). Or a user can create standard waveform limit templates on a computer (e.g. ANSI/CCITT telecommunication templates).

With the LeCroy 9300 series DSOs, specific parameter tolerance test procedures are created by selecting limits for any five out of twenty pulse parameters with Boolean AND / OR conditions between them. During testing, FAIL responses can include an audible beep, GPIB SRQ, hardcopy output, or store to memory card.

### SHARED OSCILLOSCOPE RESOURCES

By plugging-in your personal floppy disk, RAM card or PCMCIA Hard Disk you can restore your setup in seconds.

Individual users can keep preferred setups on separate disks or cards or within separate directories.

COPY FILES

Direction

Card -> Flpy

Flpy -> Card

Card -> HDD

HDD -> Card

---

Which files

Panels

Prints

Auto Wfms

Norm Wfms

All Files

---

DO COPY

!OVERWRITES FILES WITH SAME NAME

*A selection of files can be copied between the available mass storage devices*



## Hardcopy Features and Benefits

The internal printer adds a whole range of benefits to the LeCroy 9300 series:

- Ultra-fast printouts
- High resolution printing
- Easy transportation
- Trouble-free interfacing
- Auto Print on Trigger

### ULTRA-FAST PRINTOUTS

Measurement documentation is made easier and faster since the internal printer produces a hardcopy in less than 10 seconds. In addition the document is date- and time-stamped: a real bonus for archiving test results.

### HIGH RESOLUTION PRINTING

With a resolution of 190 dots-per-inch, the internal printer matches the screen's superior quality. And for even higher resolution, the printout can be stretched to a full 70 meter length so you can see those traces down to their finest details.

### EASY TRANSPORTATION

A printer that is totally integrated in the instrument makes life much easier for field-measurement applications. Imagine carrying a scope, a printer (and perhaps a floppy drive) in one hand!

## TROUBLE-FREE INTERFACING

The internal printer frees your mind from the struggle with cable schematics, baud rates, gender-changers and dip switches, for more productive tasks. Select the internal printer in the scope's utilities menu, hit the SCREEN DUMP button, and you're in business!

HARDCOPY

output to

Card

Disk

**GPIB**

RS232

Centronics

---

page feed

**OFF** On

---

plotter

DeskJet b/w

HP 7470

**HP 7550**

TIFF

TIFF compr.

---

plot size

A5(8.5"/5.5")

**A4 (11"/8.5")**

---

pen number

2

## AUTO PRINT ON TRIGGER

The Auto Print feature is used to print a screen image on each acquisition.

*The 9300 series oscilloscope supports a whole range of popular printers and plotters. Hardcopies can be either sent directly to the peripheral device or Card or Hard disk for future use.*

## OTHER HARDCOPY SOLUTIONS

High quality project reports, presentation materials, technical manuals, and troubleshooting instructions often require integration of text and graphics on the same page.

Advanced PC desktop publishing and word processors such as Word-for-Windows, WordPerfect, or AMI Pro can directly import graphic files, size them, and position them anywhere on the page. Written text can then wrap around or be positioned within the graphics.

LeCroy 9300 oscilloscopes will save screens in TIFF (Tagged Image Format File), or BMP. After transferring the file to a PC, the DTP software can import and manipulate the document like any other graphic object.

The LeCroy 9300 series also offers a wide range of interfacing capabilities with external hardcopy devices:

- Plotters. HPGL, HP 7400 and 7500 compatible
- Printers. HP LaserJet, ThinkJet, Paintjet (including color), DeskJet (including color) and Epson
- Interfacing. RS-232, GPIB, or even Centronics (included with floppy or graphics printer options).

Mass Storage Specifications			
	Floppy Disk	Ram Card	Hard Disk
Compatibility	3.5" Floppy Drive	PCMCIA Type I, II JEIDA 3.0, 4.0	PCMCIA Type III
Supported Formats	DOS Format	Read/Write: SRAM Read: OTP, ROM, Flash DOS Format	DOS Format
Size	720k byte, 1.44 MByte	up to 8 Mbytes	up to 512 Mbytes *Note 1
Max. Transfer Rate	18 kbytes/sec	500 kbytes/sec	150 kbytes/sec
Typical waveform Transfer Speed (Store/Recall)			
1000 point	1.1s / 0.4s	40ms / 30ms	140ms / 120ms
10000 point	1.8s / 1.0s	70ms / 60ms	240ms / 220ms
100000 point	7.5s / 6.5s	300ms / 300ms	1.0s / 0.9s
1 M point	57s / 55s	2s / 2s	7.0s / 6.5s

**Waveform File size:** A channel-trace will use 1 byte per sample plus approximately 360 bytes of waveform descriptor. A processed trace will use 2 bytes per sample.

**Template Size:** Approximately 21k bytes.

**Panel Setup Size:** Approximately 3k bytes.

\*Note 1: When available

## PRINTER

**Type:** Raster printer, thermal.

**Resolution:** 190 DPI

**Printout Size:** 126 mm x 90 mm

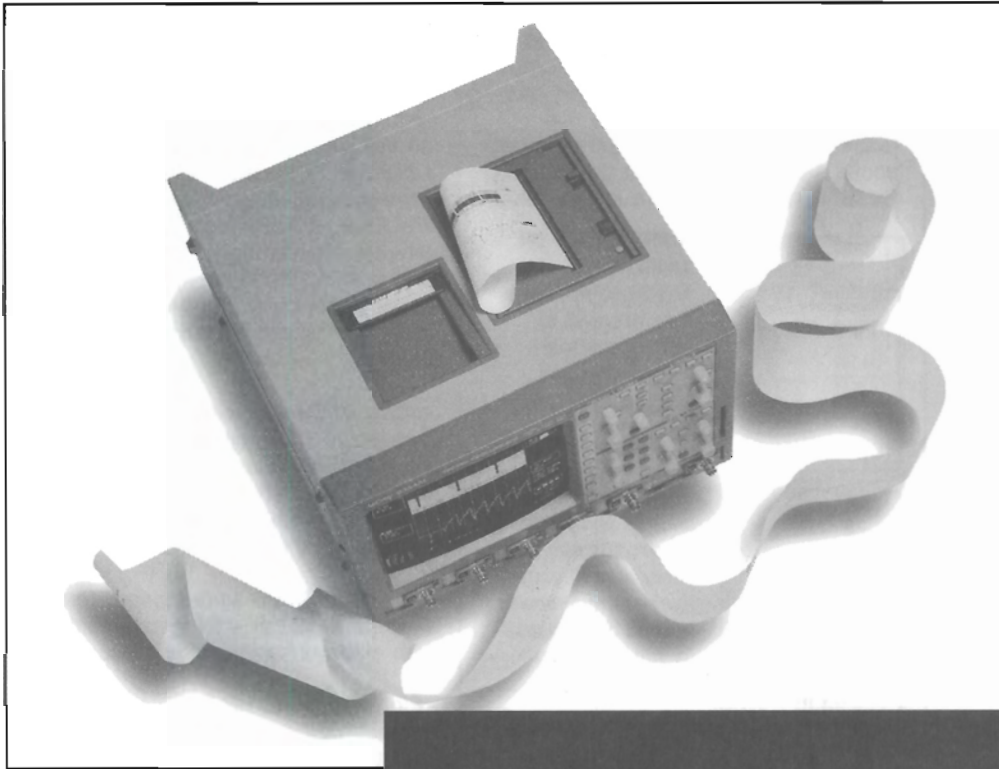

The internal high-resolution graphics printer allows detailed printouts of up to 200 cm/div as shown in the photo to the left.

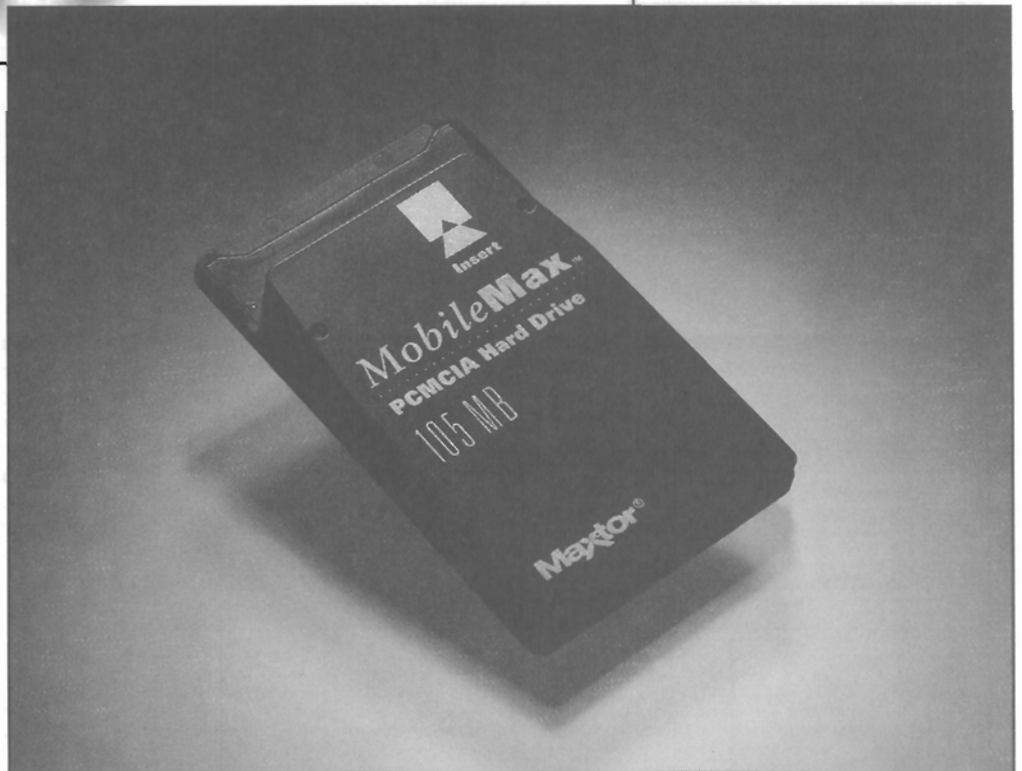

Portable PCMCIA hard drive allows the user to store data for later analysis in their scope or computer. Stores raw data, analysis or screen images for documentation. You can also have your word processing document or ISO 9000 report spreadsheet file on the same hard drive for convenience in using the data.



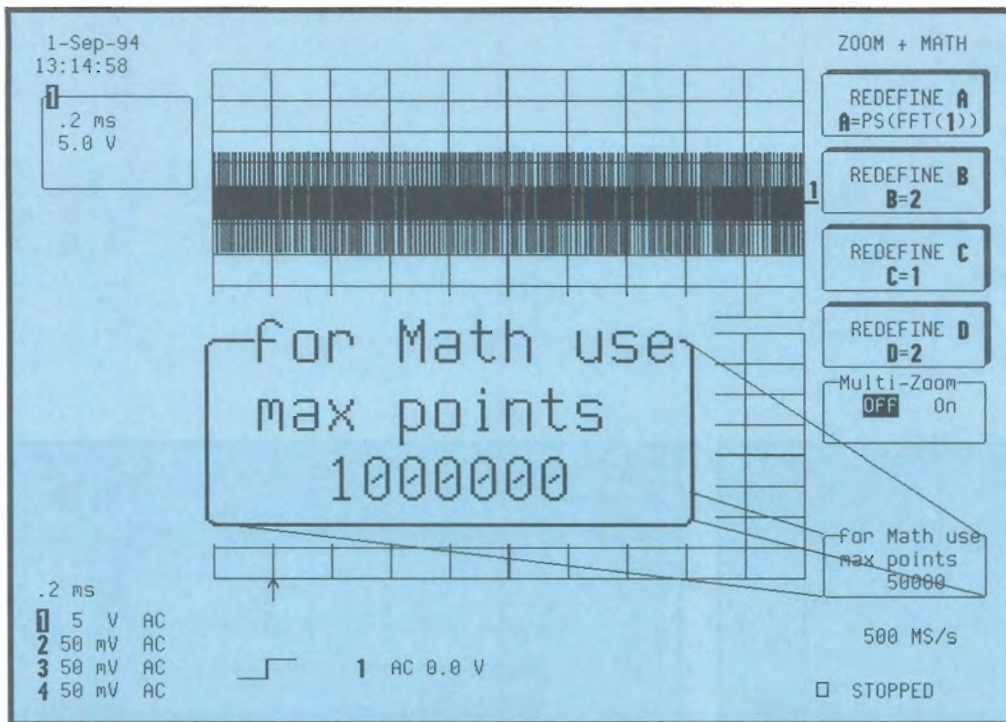

#### EXTENDED PROCESSING

The "No Math on Large Waveforms" message has been consigned to the archives. The MWP option stretches the math processing frontier for the 9300 series. You can now upgrade a 9314AL to average a 1 million point "mega" trace or you can upgrade a 9374L to perform a 6 Mpoint FFT. MWP also extends the capacity of the oscilloscope's internal memories.

#### SMART MEMORY ALLOCATION

With up to 64MB of system memory, the MWP option dramatically improves the processing power of the machine. And with the smart memory allocation, all of this memory can be dynamically dedicated to one demanding task, an FFT for example, freeing up the memory unused by other traces.

#### FASTER UPDATE

The high speed processor used in MWP upgrades is the same one installed in the 9350, 9360 and 9370 series. It enhances the processing speed of 9304A, 9310A, 9314A and 9320 scopes to yield an essential improvement in the overall DSO response. The trace update rate is amazingly fast. Also, the data processing functions have never looked so "live", providing the instantaneous response needed when fine-tuning a critical circuit under test.

#### WHY MORE MEMORY?

The example illustrated in the screenshots on the next page clearly demonstrates the advantage of processing memory for the FFT computation. For a given time window and a given acquired record length, more processing memory dramatically expands the frequency spectrum of an FFT.

## "Mega" Waveform Processing (MWP)

### Main Features

- Up to 64 MBytes of Processing RAM
- High speed processor/coprocessor
- Larger system memory extends math processing capacity on long waveforms.
- Waveforms up to 8 MBytes can be read back into the oscilloscope.
- Improved processing speed.
- System memory is dynamically allocated to traces.

**SYSTEM MEMORY**

The MWP option increases the standard system memory to 8 MBytes for MWPM and to 16 MBytes for MWPL. Model 930X-64 upgrades memory length to 64 MBytes.

**PROCESSOR**

The MWP option also upgrades the standard 16 MHz 68020/68881 processor system of a 9304A, 9310A, 9314A or 9320, to a 32 MHz 68EC030/68882 system.

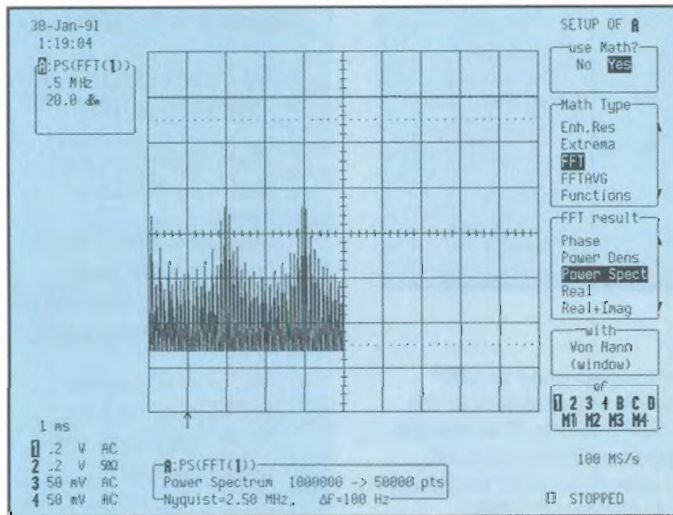

Without MWP option: The FFT processing of a 1 M point record length is limited to 50k; as a result the spectrum is limited to 2.5 MHz.

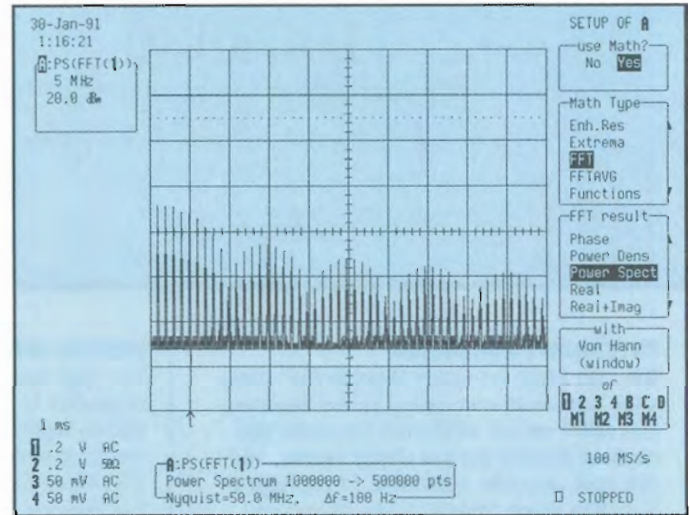

With MWP option: The same signal processed with a 500kpoint FFT shows a full spectrum of 50 MHz.

Mega Waveform Processing Option		
Task Example	Without MWP	With MWP
Retrieve a 1M waveform saved on a floppy, to the scope	Impossible: requires more than 2MByte of memory	Possible.
Perform an FFT on a 200k waveform	Possible, by limiting the input points, which also limits the resulting FFT bandwidth	Possible without reducing the input points. The FFT spectrum will cover the full bandwidth.
Average 1000-point waveforms at a 100 Hz sweep rate	Impossible for 9304A, 9310A, 9314A or 9320 scopes, the maximum rate is 80 Hz: some events will be missed.	Possible, the maximum rate can actually reach 125 Hz, a 56% improvement!





## EXTERNAL CLOCK

This feature allows the 9350A and 9370 series DSOs to be externally clocked at a fixed rate from 50 MS/s to 500 MS/s, enabling full phase control over the acquired signal. The sample rate can be fine-tuned to the exact speed required by the application.

## EXTERNAL REFERENCE

The external reference allows the scope to be phase-synchronized to an external 10 MHz reference, either to match the stability of the external source or to phase lock the acquired signal. Several DSOs can then be synchronized using a simple source as reference.

## TRIGGER COMPARATOR

The trigger comparator signal outputs a pulse for each valid edge-trigger condition

on the trigger signal. This is an invaluable feature for event-counting and throughput applications.

In applications as diverse as capturing radar signals and making advanced measurements on magnetic media using PRML methods, there can be requirements to sample the data at defined frequencies.

The 9350A and 9370 series scopes have the ability to accept a data sampling clock through the front panel at frequencies up to 100 MS/s. This is applied through the BNC connector that is normally used for the external trigger. The CKTRIG option is for those applications requiring a higher speed sample clock (up to 500 MS/s) or where the external trigger input is required for triggering the scope.

## **CKTRIG** **Hardware** **Option for the** **9350A and** **9370 Series** **Oscilloscopes**

### Main Features

- High speed 500 MHz external clock input.
- 10 MHz external clock reference input.
- Edge trigger comparator output.
- BNC, rear-panel mounted connectors.

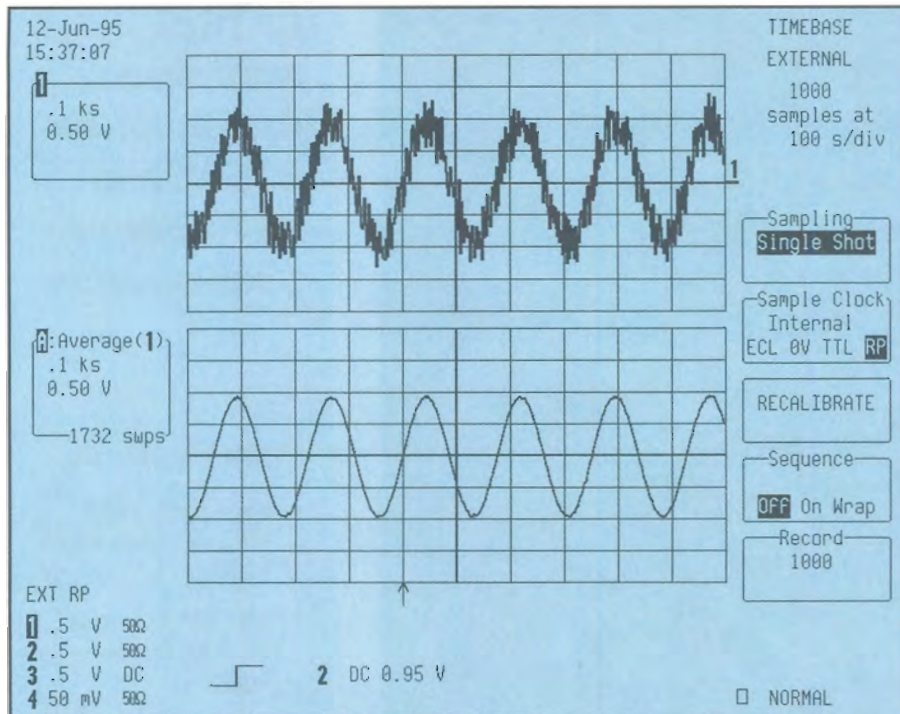

This figure shows how synchronous sampling can eliminate interfering signals. In the picture above a 455 kHz communications signal with interference and noise is sampled using the Rear Panel ("RP") external sampling clock input available in the CKTRIG option. The top trace shows a single shot of the signal. The interference source has a frequency very near the carrier of the desired signal. The sample clock has been set to be synchronous with the known frequency of the underlying signal. The effects of the noise and interference have been eliminated in the lower trace which is an average of 1732 acquisitions. The measurement is successful because the user was able to set the sampling at a frequency where both the noise and interference would average to zero while the underlying data remained constant.

#### EXTERNAL CLOCK INPUT

##### Input signal requirements:

**Amplitude:** 800 mV p-p

**Frequency range:** 50 MHz to 500 MHz

**Offset:** 0 V

**Input impedance:** 50Ω.

Calibration must be initiated for each external clock change.

The negative pulse width must be less than 5ns. (2ns recommended)

**Swept Clock:** Only a fixed frequency external clock is supported. Swept clocks will cause substantial offset errors (10% worst-case).

##### External Clock Reference Input

##### Signal Requirements:

**Amplitude:** 800 mV p-p

**Frequency range:** 10 MHz  $\pm$ 5%

**Offset:** 0 V

**Input impedance:** 50Ω.

#### TRIGGER COMPARATOR OUTPUT

The comparator operates in a 'time-over-threshold' mode and generates a pulse edge of the same polarity as the polarity of the selected triggering edge each time a valid EDGE TRIGGER condition is met on the trigger signal. The duration of the pulse will be equal to the time the trigger signal is above/below the trigger level.

**Note:** This feature does not operate in SMART TRIGGER mode.

**Output signal characteristics:** ECL, 50Ω, series-terminated.



LeCroy DSO Model Number	Max Transient Sample Rate	Max Repetitive Sample Rate	Analog BW (Minimum)	Number of Channels	Memory per Channel	Processing RAM	See Page #
<b>Medium Performance Scopes</b>							
9304A	100 MS/s	10 GS/s	200 MHz	4	50k	2M	15
9304AM	100 MS/s	10 GS/s	200 MHz	4	200k	2M	15
9310A	100 MS/s	10 GS/s	400 MHz	2	50k	2M	19
9310AM	100 MS/s	10 GS/s	400 MHz	2	200k	2M	19
9310AL	100 MS/s	10 GS/s	400 MHz	2	1M	2M	19
9314A	100 MS/s	10 GS/s	400 MHz	4	50k	2M	19
9314AM	100 MS/s	10 GS/s	400 MHz	4	200k	2M	19
9314AL	100 MS/s	10 GS/s	400 MHz	4	1M	2M	19
<b>High Performance Scopes</b>							
9350A	1 GS/s	10 GS/s	500 MHz	2	25k/2 Ch 50k/1 Ch	4M	27
9350AM	1 GS/s	10 GS/s	500 MHz	2	100k/2 Ch 250k/1 Ch	8M	27
9350AL	1 GS/s	10 GS/s	500 MHz	2	2M/2 Ch 4M/1 Ch	16M	27
9354A	2 GS/s	10 GS/s	500 MHz	4	25k/4 Ch 50k/2 Ch 100k/1 Ch	4M	27
9354AM	2 GS/s	10 GS/s	500 MHz	4	100k/4 Ch 250k/2 Ch 500k/1 Ch	8M	27
9354TM	2 GS/s	10 GS/s	500 MHz	4	500k/4 Ch 1M/2 Ch 2M/1 Ch	8M	27
9354AL	2 GS/s	10 GS/s	500 MHz	4	2M/4 Ch 4M/2 Ch 8M/1 Ch	16M	27
9370	2 GS/s	10 GS/s	1 GHz	2	25k/2 Ch 50k/1 Ch	4M	35
9370M	2 GS/s	10 GS/s	1 GHz	2	100k/2 Ch 250k/1 Ch	8M	35
9370L	2 GS/s	10 GS/s	1 GHz	2	2M/2 Ch 4M/1 Ch	16M	35
9374	2 GS/s	10 GS/s	1 GHz	4	25k/4 Ch 50k/2 Ch 100k/1 Ch	4M	35
9374M	2 GS/s	10 GS/s	1 GHz	4	100k/4 Ch 250k/2 Ch 500k/1 Ch	8M	35
9374L	2 GS/s	10 GS/s	1 GHz	4	2M/4 Ch 4M/2 Ch 8M/1 Ch	16M	35
<b>Specialty Application Scopes</b>							
9320	20 MS/s	20 GS/s	1 GHz	2	5k	2M	23
9324	20 MS/s	20 GS/s	1 GHz	4	5k	2M	23
9361	2.5 GS/s	N/A	300 MHz	2	500 - 25k	100k	31
9362	10 GS/s	10 GS/s	1.5 GHz	2	500 - 25k	100k	31

# Ordering Information

## 9300 Series

Model #	9300 Series Digital Oscilloscopes	U.S. \$
9304A	4 Ch 200 MHz 100 MS/s Scope 50k Memory/Ch	5,990
9304AM	4 Ch 200 MHz 100 MS/s Scope 200k Memory/Ch	6,990
9310A	2 Ch 400 MHz 100 MS/s Scope 50k Memory/Ch	4,990
9310AM	2 Ch 400 MHz 100 MS/s Scope 200k Memory/Ch	5,990
9310AL	2 Ch 400 MHz 100 MS/s Scope 1Meg Memory/Ch	10,490
9314A	4 Ch 400 MHz 100 MS/s Scope 50k Memory/Ch	7,860
9314AM	4 Ch 400 MHz 100 MS/s Scope 200k Memory/Ch	9,440
9314AL	4 Ch 400 MHz 100 MS/s Scope 1Meg Memory/Ch	15,740
9320	2 Ch 1 GHz 20 GS/s Scope Sampling Scope	7,490
9324	4 Ch 1 GHz 20 GS/s Scope Sampling Scope	11,490
9350A	2 Ch 500 MHz 500 MS/s 50k Memory/Ch Scope 1 GS/s 100k Memory/1Ch	9,990
9350AM	2 Ch 500 MHz 500 MS/s 250k Memory/Ch Scope 1 GS/s 500k Memory/1 Ch	11,490
9350AL	2 Ch 500 MHz 500 MS/s 2 Meg Memory/Ch Scope 1 GS/s 4Meg Memory/1 Ch	16,490
9354A	4 Ch 500 MHz 500 MS/s 50k Memory/Ch Scope 2 GS/s 200k Memory/1 Ch	13,490
9354AM	4 Ch 500 MHz 500 MS/s 250k Memory/Ch Scope 2 GS/s 1Meg Memory/1 Ch	16,490
9354AL	4 Ch 500 MHz 500 MS/s 2 Meg Memory/Ch Scope 2 GS/s 8Meg Memory/1 Ch	24,490
9354TM	4 Ch 500 MHz 500 MS/s 500k Memory/Ch Scope 2 GS/s 2Meg Memory/1 Ch includes WP01/02/FDGP	19,990
9361	2 Ch 300 MHz 2.5 GS/s Scope 500 to 25k Memory/Ch	8,990
9362	2 Ch 1.5 GHz 10 GS/s Scope 500 to 25k Memory/Ch	14,990
9370	2 Ch 1 GHz 500 MS/s 50k Memory/Ch Scope 1 GS/s 100k Memory/1 Ch	11,490
9370M	2 Ch 1 GHz 500 MS/s 250k Memory/Ch Scope 1 GS/s 500k Memory/1 Ch	12,990
9370L	2 Ch 1 GHz 500 MS/s 2 Meg Memory/Ch Scope 1 GS/s 4 Meg Memory/1 Ch	17,990
9374	4 Ch 1 GHz 500 MS/s 50k Memory/Ch Scope 2 GS/s 200k Memory/1 Ch	16,490
9374M	4 Ch 1 GHz 500 MS/s 250k Memory/Ch Scope 2 GS/s 1 Meg Memory/1 Ch	19,490
9374L	4 Ch 1 GHz 500 MS/s 2 Meg Memory/Ch Scope 2 GS/s 8 Meg Memory/1 Ch	27,490

VISA AND MASTER CARD ACCEPTED



## 9300 Series

		U.S. \$
<b>Options</b>		
9304-SM	9304 Service Manual, Covers 9304 and 9304M	125
9304A-SM	9304A Service Manual Covers 9304A and 9304AM	125
9300-OEMKIT	OEM Kits are available for 9300 series scopes	Consult factory
9310-SM	9310 Service Manual, Covers 9310/M/L	125
9310A-SM	9310 Service Manual, Covers 9310A/M/L	125
9314-SM	9314 Service Manual, Covers 9314/M/L	125
9314A-SM	9314A Service Manual Covers 9314A/M/L	125
931X-OM	Operator's and Programmer's Manual Included with 9304/9310/9314	85
932X-OM	9320 & 9324 Operator's Manual Included with 9320 and 9324	85
9320-SM	9320 Service Manual	125
9324-SM	9324 Service Manual	125
9350-SM	Service Manual, Covers 9350/M/L	125
9354-SM	Service Manual, Covers 9354/M/L	125
935X-OM	9350 Series Operator's Manual, Included with 9350/9354	85
935XA-CKTRIG	935XA Series External Clock, Ref Clock Includes trigger comparator output	490
9360-OM	9360 Operator's Manual, Included with 9360 and 9361	85
9360-SM	9360 Service Manual, Covers 9360 and 9361	125
93XXC2	Choice of any two of WP01, WP02, WP03 or PRML	1,875
93XXC3	Choice of any three of WP01, WP02, WP03 or PRML	2,490
93XX-DA01	Type III Adapter for Computer	360
93XX-DDM	Disk Drive Measurement Package	3,000
93XX-FD01	Floppy Disk Option	590
93XX-FDGP	Graphic Printer & Floppy Disk Options	1,190
93XX-GP01	Graphic Printer Option	890
93XX-HDD	Type III PCMCIA Slot w/130 MByte Hard Drive	990
93XX-HD01	Type III PCMCIA Slot	590
93XX-HD02	130 MByte PCMCIA Hard Drive	499
93XX-MC01/04	Memory Card Reader w/512k Card, For 9300 Series	500
93XX-MWPL	32 MHz 68030/68882 w/16 MByte RAM	1,490
93XX-MWPM	32 MHz 68030/68882 w/8 MByte RAM	990
93XX-PRML	PRML Analysis Package	1,250
93XX-TP	Total Performance Package for 9300 Series Includes WP01/02 and FD01	2,000
93XX-VP1	Includes WP01/02 and DDM Analysis	3,850
93XX-VP2	Includes WP01/02, DDM and PRML Analysis	4,725
93XX-VP3	Includes DDM Package and PRML Analysis	3,187
93XXWP01	9300 Series Waveform Processing, Advanced Math Option	1,250
93XXWP01/02	9300 Series Waveform Math/FFT	1,875
93XXWP02	9300 Series Spectrum Analysis, FFT Option	1,250
93XXWP03	9300 Series Histogram Analysis, Parameter Analysis Option	1,250

# 1-800-5-LECROY

9300 Series Ordering Information

## 9300 Series

		U.S. \$
<b>Accessories</b>		
93XX-FC	Protective Front Cover 9300 Series	50
93XX-FD-TC1	Telecom Templates On 3.5" Floppy Disk	350
93XX-GPR10	Graphic Printer Paper/10 Rolls	100
93XX-MC02	128k Memory Card for 9300 Series	175
93XX-MC04	512k Memory Card for 9300 Series	330
93XX-MC-TC1	Telecom Templates On 512k SRAM card	700
93XX-RM01	Rackmount Adaptor for 9300 Series Scope	100
93XX-TC1	Hard Carrying Case for 9300 Series Scope	570
93XX-TC2	Soft Carrying Case for 9300 Series Scope	225
94XX-MC02	128k Memory Card	175
94XX-MC04	512k Memory Card	330
94XX-MC-TC1	Memory Card Telecom Template	700
LS-RM	Rackmount Adapter for LS140	340
LS-RS232/PLOT	RS232 Cable LS140 to Printer/Plotter Connects LS140 to DTE device	50
LS-RS232/REM	RS232 Cable LS140 to IBM AT Computer 9 Pin Female to 9 Pin Female Connector	80
LS-SOFT	Soft Carrying Case for an LS140	199
LS-TRANS	Transit Case for LS140	570
OC9002	Oscilloscope Cart for 9300, 9400 and LS140 Series Compatible with FD/GP Option for 9300	555
OC9003	Oscilloscope Cart with Drawer and Printer Shelf	795
RM9400-SERIES	Scope Rackmount Adapter 9400 Series - with front panel switch	690
SG9001	Overload Protector for High Voltage	120
TC9001	Hard Carrying Case for 9400 Series Scope	660
TC9002	Soft Carrying Case for 9400 Series Scope	270
<b>9300 Series Portable Digital Scope Probes</b>		
AP020	1 GHz Active FET Probe (10:1) With ProBus connector	990*
AP021	800 MHz Active FET Probe (5:1) With ProBus connector	990*
AP030	15 MHz Differential Probe (10x, 100x)	300*
AP082	SDH:STM-1E Trigger Pickoff Includes 93XX-FD-TC1	990*
AP083	SONNET:STS-3 Trigger Pickoff Includes 93XX-FD-TC1	990*
AP1143A	Probe Offset/Power for AP54701A	1,701**
AP54701A	2.5 GHz Active FET Probe (10:1) Requires AP1143A Power Supply	3,194**
D9010	10:1 High Impedance Divider	160
D9011	10:1/1:1 High Impedance Divider	160
D9012	Divider 1:10 1 M $\Omega$	165
D9013	Divider 1:10 1 M $\Omega$	165
P9010	10:1 Scope Probe Coline Probe	65
P9010/2	10:1 Scope Probe Length 2 m Coline Probe	80
P9011	10:1/1:1 Probe for 9400 Series Coline Probe	80
P9100	100:1 Probe for 9400 Series Coline Probe	80

VISA AND MASTER CARD ACCEPTED

\* 30% discount when purchased with an oscilloscope

\*\* 28% discount when purchased with an oscilloscope



## 9300 Series

		U.S. \$
PMM502	Passive Probe 500 MHz fine pitch MiniProbe x10 with sense ring	300
PP002	10:1 350 MHz 1 MΩ Passive Probe	80
PP012	100:1 300 MHz 1MΩ Passive Probe	95
PP062	10:1 1 GHz 500Ω Passive Probe	95
PP064	100:1 1 GHz 500Ω Passive Probe	95
SI9000	15 MHz Differential Probe x20/x200	300
SI9000A	15 MHz Differential Probe x50/x500	300

### Warranties & Calibrations

93XX-C5	5 NIST Calibrations on any 9300 Series Scope	650
93XX-CC	NIST Calibration Certificate on any 9300 Series Scope At time of purchase	175
93XX-CM5	5 MILSTD Calibrations on any 9300 Series Scope MILSTD 45662A Calibration	1050
93XX-EW	1 Year Extended Warranty on any 9300 Series Scope Includes NIST Calibration	550
93XX-MIL	MILSTD 45662A Calibration on any 9300 Series Scope	275
93XX-T5	5 Year Warranty & NIST Cal on any 9300 Series Scope	975
93XX-W5	5 Year Repair Warranty on any 9300 Series Scope	545
94XX-CC	NIST Calibration on any 9400 Series Scope At time of purchase	275
94XXC5	5 NIST Calibrations on any 9400 Series Scope	795
94XXCM5	5 MILSTD Calibrations on any 9400 Series Scope MILSTD 45662A Calibration	1,295
94XX-EW	1 Year Extended Warranty Includes NIST Calibration	550

# 1-800-5-LECROY

9300 Series Ordering Information

# Ordering Information

## 9300 Series Upgrade Path

If you own an older 9300 series scope than the ones shown on earlier pages of this catalog you can upgrade it to the newest performance levels. LeCroy is the only scope company that lets you upgrade your scope to keep up with technology.

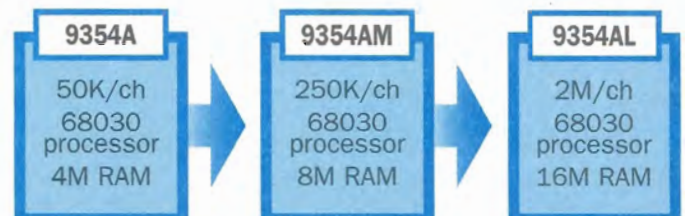
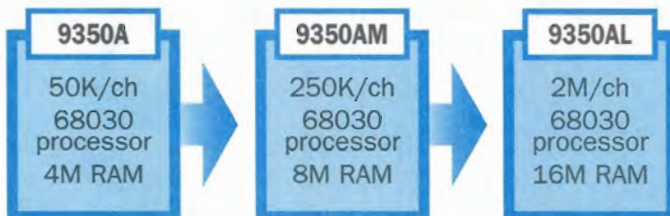
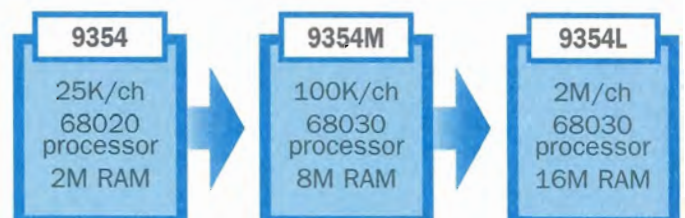
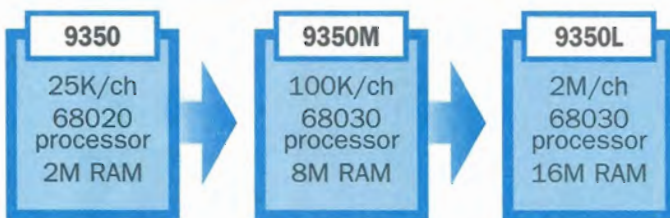
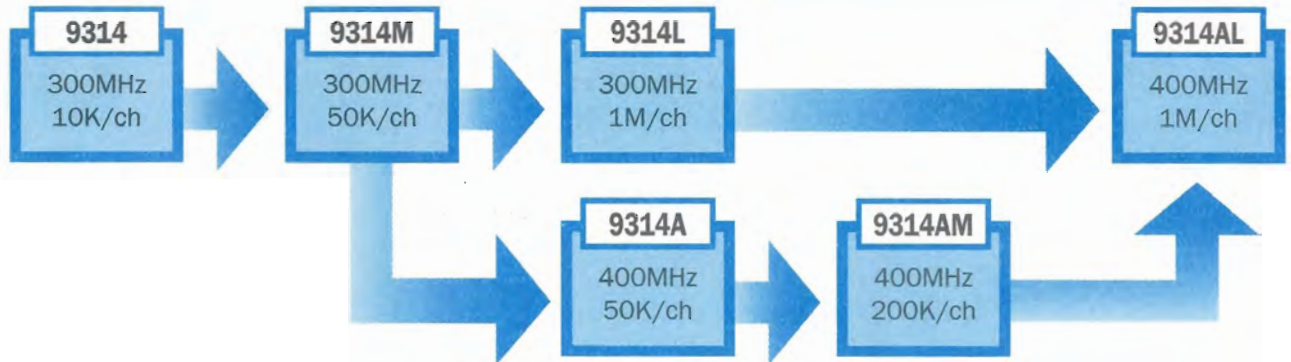
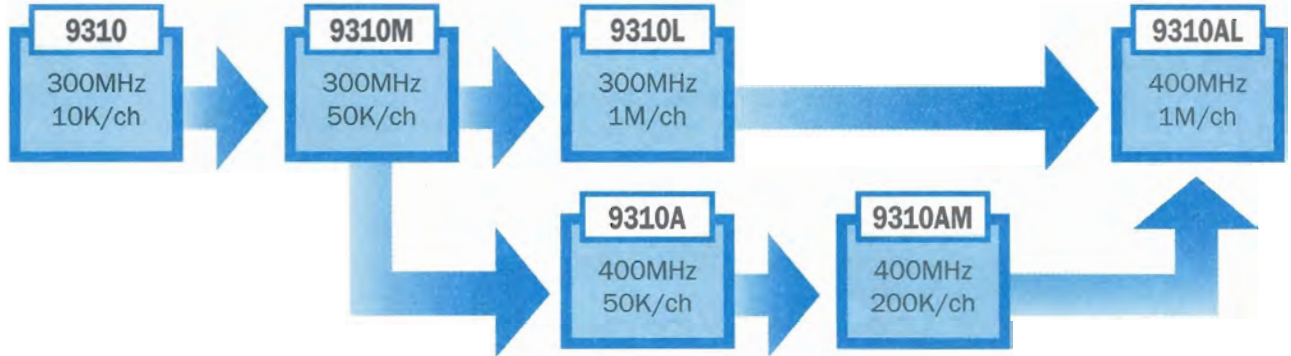
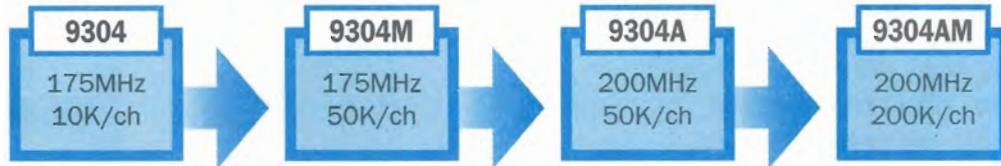



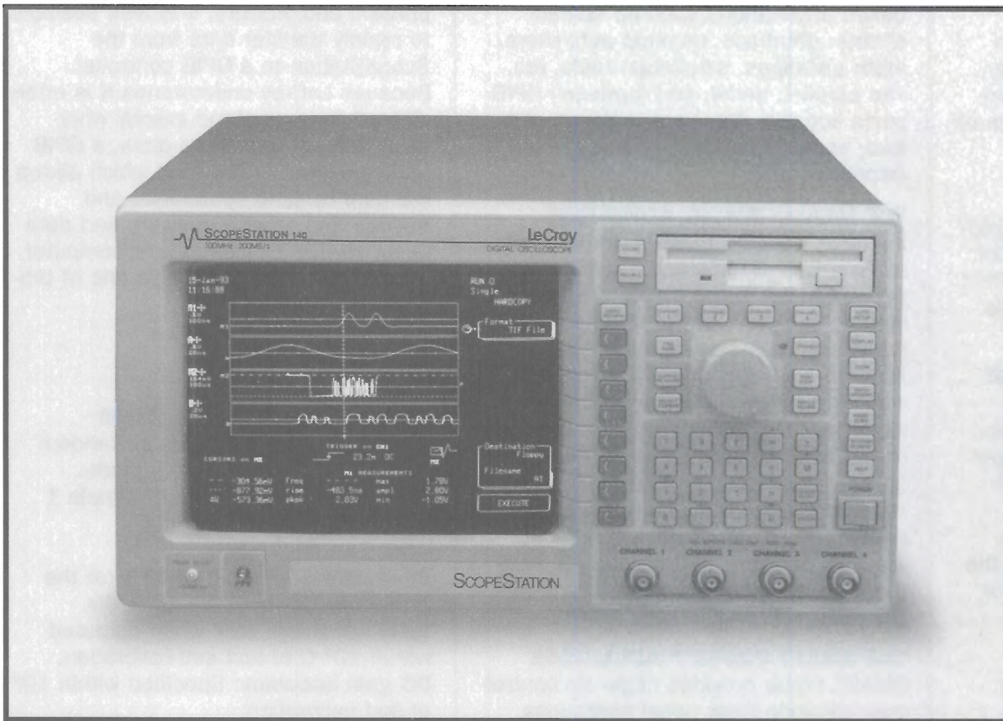

## ScopeStation 140 . . .

Setting a new standard for problem solving, this exciting new platform combines powerful data handling features with a precision digital oscilloscope. Putting your measurement results to work has never been this easy and flexible. Now with the push of a button, you can transfer waveforms, measurements, and display information to spreadsheet files, DOS-compatible floppy disks, an internal hard drive, GPIB, RS232, printers, plotters, or word processing documents.

The powerful connectivity features of the ScopeStation 140, integrated into a state-of-the-art digital oscilloscope, provides never before available solutions to your toughest testing, servicing, and remote monitoring tasks.

Data capture and archiving, statistical analysis, automated and semi-automated testing can be performed from a single instrument with repeatability and ease, improving throughput in manufacturing test. ScopeStation 140 is fully programmable over RS-232 or optional GPIB so it can become a powerful addition to your test systems.

ScopeStation provides test data in spreadsheet files, ASCII, Binary, TIFF, PCX, BMP,

HPGL, P-Spice or MathCad formats. Capture the data and transfer it to your computer directly over GPIB, RS232 or by using the floppy drive. Develop a statistical data base to pinpoint opportunities to streamline your process and improve your cost of manufacturing.

For service applications in the lab and in the field, troubleshooting procedures can be sequenced through at the push of a button on the Smart Probe. Waveform or measurement data can be saved to floppy disk.

In remote monitoring applications, ScopeStation's pass/fail testing provides the perfect solution to monitoring critical equipment at remote locations. When a failure occurs, ScopeStation will date and time stamp the data.

### THE DIGITIZING ADVANTAGE

The ScopeStation 140 delivers capture and analysis capabilities for signals up to 100 MHz in frequency. Data is acquired through four channels with two precision 8-bit flash ADCs at rates up to 200 MS/sec for single shot events and up to 8 GS/sec for repetitive signals. The alias protect mode processes data from the ADCs at the full 200 MS/sec speed to provide alias protection for signals up to 100 MHz. Using alias protect mode, any glitch greater than 10 nsec can be displayed on any time/division range.

**ScopeStation  
140 Portable  
Digital  
Oscilloscope  
100 MHz  
Bandwidth,  
200 MS/sec,  
4 Channels**

### Main Features

- Record lengths to 20,000 samples per channel
- Pass/fail testing
- 3.5" DOS floppy disk
- Optional internal 100 MByte hard disk
- Cascade display up to 24 traces
- Smart Probe™ for remote operation from the probe
- Smart Trigger™ for capturing and displaying complex signals
- Alias protect acquisition mode
- Waveform and measurement data to spreadsheet and database files
- Standard RS-232C and Centronics interfaces



**THE SETUP ADVANTAGE**

Pressing the Auto Setup button automatically scales the timebase, trigger, and vertical sensitivity settings to provide a stable display for a wide range of repetitive input signals.

Setups can be easily saved and recalled from floppy disk allowing rapid setup. To make vertical setup easy for standard logic signals, there are built-in presets for TTL, ECL, and CMOS logic signals.

**THE SMART TRIGGER™ ADVANTAGE**

Using SMART Trigger you capture and see exactly what you want to see. SMART Trigger provides a glitch trigger to trigger on glitches as small as 10 ns. TV trigger provides triggering on NTSC, PAL, and SECAM signals. The SMART trigger hold-off mode allows the trigger to be held off either by time or by events.

**THE DISPLAY ADVANTAGE**

The bright 9" high resolution display makes measurements easy to read with display modes to suit your application. The cascade display illuminates timing problems and bit patterns by displaying up to 24 traces on one screen. A choice of single, dual, and quad grids makes separating channels and traces easy.

The XY display plots any two traces against each other. The persistence mode shows traces as they accumulate over time. A connection is even provided for an external VGA-compatible monitor.

**THE PROCESSING ADVANTAGE**

Waveform processing, which includes zoom, arithmetic functions (add, subtract, and invert), summation averaging, continuous averaging and smoothing is standard. Smoothing provides up to 11-bits of resolution. Summation and continuous averaging help reduce noise.

**THE DATA OUTPUT ADVANTAGE**

ScopeStation's data handling features make putting your data to work simple. The DOS compatible 3.5" floppy drive makes it easy to carry stored setups, waveforms, and measurements in your shirt pocket. There is no need to write a GPIB program to get data on to your PC. Just save the waveform on the floppy disk. Insert the disk in your PC and retrieve the data.

Data can be saved and communicated in a number of convenient formats. The formats allow easy data import into PC-

based applications such as spreadsheets, database, desktop publishers, math packages, simulation tools, etc. The parallel, serial, and (optional) GPIB ports connect directly to printers, plotters, and computers for hardcopy and remote control.

**THE MEASUREMENT ADVANTAGE**

Eighteen waveform measurements are available for display and remote read out. Up to six of the measurements may be selected for live updates. The measurements may be calculated on live, stored, expanded, or processed waveforms. The measurements may be calculated on the entire record or on a region of the record gated by the cursors. Four cursor types are available for manual waveform measurements and marking regions of interest. To make analysis of standard logic signals easy there are built-in cursor thresholds for TTL, ECL, and CMOS logic levels.

**THE SMART PROBE™ ADVANTAGE**

SMART Probe provides finger tip control over common front panel operations. You never need to take your hands off the probe to change a setting, freeze the display, or plot a hard copy. Front panel operation can be tied to the SMART Probe for finger tip control.

**GPIB OPTION**

- IEEE 488.2 compatible
- Full remote control
- Hardcopy to GPIB printers and plotters
- SCPI command set compatible

The LeCroy ScopeStation 140 GPIB option extends the interfacing capabilities of the ScopeStation with a GPIB (IEEE-488.2) interface. This option provides full remote control of the ScopeStation. All remote commands can be sent in English like format or in abbreviated format for increased throughput. Command format is fully compatible with IEEE-488.2 standard and SCPI command set. Commands control all aspects of the ScopeStation including all settings, acquisitions, processing, and measurements.

When using Remote Commands from the GPIB bus it is possible lock out the front panel operation to prevent accidental changes to settings or the front panel may remain fully active with front panel commands immediately removing the ScopeStation from Remote Mode.

Using the ScopeStation-GPIB option it is possible to perform hardcopies to GPIB

printers and plotters. It is also possible to rapidly transfer data from the ScopeStation to a GPIB controller. Because LeCroy understands it is often difficult to understand exactly what each Remote command does, a GPIB utility program is provided which allows the user to send commands and queries and receive answers and data using an IBM PC compatible computer without ever writing a single line of program

**Specifications****SIGNAL ACQUISITION SYSTEM**

**Channels:** 4 full channels in Random Interleaved Sampling (RIS) mode.

**Simultaneous channels:** Channels 1 and 2 or Channels 3 and 4.

**ADC:** Two 8-bit Flash.

**Bandwidth (-3 dB):** 100 MHz (at the probe tip), 10 mV/div - 10 V/div.

**Total accuracy:**  $\pm 2\%$  when operated within 10° C of last self-calibration.

**DC gain accuracy:** Specified within 10° of last calibration.

1% of Full Scale +1% of Offset  
+1 mV (5 mV/div to 100 mV/div)  
+10 mV (200 mV/div to 1 V/div)  
+100 mV (2 V/div to 10 V/div)

**Vertical resolution:** 8 bits.

**Analog bandwidth selections:** 20 MHz and full. Independently selectable for each channel.

**Input coupling:** AC, DC, or GND.

**Input impedance selections:** 1 M $\Omega$   $\pm 1\%$  in parallel with 20 pF  $\pm 10\%$ .

**Input attenuation ranges:** 5 mV/div to 10 V in 1, 2, 5, 10 sequence.

**Input offset range:**

>  $\pm 1$  V from 5 mV/div to 100 mV/div  
>  $\pm 10$  V from 200 mV/div to 1 V/div  
>  $\pm 100$  V from 2 V/div to 10 V/div

**Maximum input voltage:**  $\pm 400$  V, DC + peak AC (maximum 10 kHz).

**Channel isolation:** > -40 dB at 25 MHz, for channels set to same V/div.

**AC coupled low frequency limit:** 10 Hz  $\pm 1$  Hz

**ACQUISITION MODES**

**Alias protect:** Alias protect acquisition, high frequency, and glitch capture.

Captures glitches as small as 10 nsec on (real time) time/div settings.

**Sample rate:** Maximum real-time sample rate 200 MS/sec. In random interleaved sampling mode (RIS), 8 GS/sec maximum on 5 nsec to 0.1  $\mu$ sec/div ranges. Disengages alias protect operation.

**Envelope:** See Waveform Processing.

**Average:** See Waveform Processing.

**Smoothing:** See Waveform Processing.



## TIME BASE SYSTEM

**Sampling rate:** Single shot - 200 MS/sec. Repetitive - 8 GS/sec.  
**Time per division range:** 5 nsec to 50 sec/div.  
**Timebase accuracy:**  $< \pm 0.01\%$ .  
**Record length:** 2k samples per channel, 20k (Optional).  
**Pre-trigger selectable from:** 0 to 100% of record length with sample point resolution.  
**Delay:** 0 to 10,000 divisions with sample point resolution.

## TRIGGER SYSTEM

**Triggers:** Edge or Smart Trigger.  
**Main trigger modes:** Auto, normal, single.  
**Coupling:** DC, DC bandwidth limit, AC, AC bandwidth limit, LF reject, LF reject bandwidth limit, HF reject.

## SMART TRIGGER

**Hold-off by time:** 40 nsec to 80 sec (resolution of 20 nsec).  
**Hold-off by events:** 1 to 109 (> 40 nsec apart).  
**TV trigger:** Stable triggering on TV signals that comply with PAL, SECAM, NTSC standards. Selection on both line and field number.  
**Glitch and width:** Trigger on pulse width > or < the operator set limit. Trigger on glitches as small as 10 nsec.  
 Width > (10 nsec to 20 sec).  
 Width < (10 nsec to 20 sec).  
**Resolution:**  $\pm 1$  ns +15% of setting.  
**Rearm time:** 30 nsec.  
**Interval:** Trigger on pulse distances < or > the operator set limit.  
 Interval > (30 nsec to 20 sec).  
 Interval < (10 nsec to 20 sec).  
**Resolution:**  $\pm 1$  ns +.05% of setting.  
**Rearm time:** 30 nsec.  
**Dropout:** Trigger whenever the input signal does not occur for longer than an operator selectable timeout.  
**Trigger on dropout:** (30 nsec to 20 sec).  
**Resolution:**  $\pm 1$  ns +0.05% of setting.  
**Rearm time:** 30 nsec.

## DISPLAY

**Waveform style:** Dots, vectors, or infinite persistence.  
**Graticule style:** Full, border, and crosshair.  
**Graticule type:** Single, dual, quad, single and XY, full screen XY, up to 24 trace cascade.  
**Format:** YT, XY, YT and XY simultaneously.

## CURSOR MEASUREMENTS

**Cursor types:** Amplitude, time, attached, logic level.  
**Attached:** Two cross-hair markers measure time relative to the trigger, time relative to each other. Absolute voltage relative to signal ground, and voltage relative to each other.  
**Time:** Two vertical bars provide relative and absolute time and frequency measurements.  
**Amplitude:** Two horizontal bars measure relative time and frequency.  
**Logic level:** Four horizontal bars mark the levels for VIL, VIH, VOL, VOH. The logic cursors may be preset for: TTL, ECL, 5 V CMOS, 10 V CMOS, and 15 V CMOS logic.

## AUTOMATIC MEASUREMENTS

Automatic measurements are based upon the ANSI/IEEE Standard. The following eighteen measurements are standard of which any six may be displayed in a live updating fashion.

Amplitude	Base	Delay
Duty Cycle	Fall Time	Frequency
Maximum	Mean	Minimum
Overshoot Positive	Overshoot Negative	
Period	Peak-to-Peak	Rise Time
RMS	Top	Width
Positive	Width Negative	

## WAVEFORM PROCESSING

**Arithmetic operators:** Add, subtract and invert.  
**Averaging:** Summation averaging of waveform data selectable from 1 to 1,000 sweeps. Continuous averaging.  
**Smoothing:** Adjacent sample averaging of data using windows of 3, 5, 7, 25, 49 or 55 samples.  
**Envelope:** Capture and view glitches of 10 nsec or greater in duration with 100% confidence. Assures against display of aliased waveform.  
**Floor:** MIN values acquired over 1 or more acquisitions.  
**Roof:** MAX values acquired over 1 or more acquisitions.  
**Zoom:** Zoom feature allows waveforms to be expanded, compressed, and positioned both horizontally and vertically.

## HARDCOPY

**Printers:** Canon BubbleJet, Epson MX, Epson FX, Epson LQ, HP-ThinkJet, HP-DeskJet, HP-LaserJet.  
**Plotters:** HPGL, HP74XX, 75XX, 7475A, ColorPro  
**Graphics formats:** PCX, TIFF, BMP  
**Data formats:** ASCII, MathCad™, PSPICE™, Spreadsheet.

## STORAGE

**Floppy disk:** 3.5" 1.44 Mbyte DOS format used for storing setups, waveforms, and hardcopy output.

## COMPUTER INTERFACES

**Centronics parallel standard:** Hardcopy.

**RS-232C standard:** Remote control of modes, settings, and measurements; hardcopy.

**GPIB IEEE 488.2 (optional):** Fully programmable talk and listen modes; full remote control; hardcopy.

## POWER REQUIREMENTS

**Line voltage range:** 90-137 V rms or 180-265 V rms switchable.

**Power consumption:** 280 Watts maximum, 200 Watts (typical)

## SCOPESTATION 140 INCLUDES

- Four 10x Scope Probes
- Operators Manual
- Getting Started Guide
- 2 Year Warranty
- Power Cord
- One Install Disk

## GPIB OPTION

### Hardware Specifications:

GPIB (IEEE-488.2) Compatible Interface Card. SCPI-compatible command set.

### Remote Control:

GPIB port is configured as a Talker/Listener for computer control and fast data transfer. GPIB port is configured as a Talker Only for Hardcopy

## REMOTE HARDCOPY

Hardcopy to any of the ScopeStation supported printers and plotters that have a GPIB interface.

**Printers:** HP-ThinkJet, HP-DeskJet, HP-LaserJet, Epson FX, Epson MX, Epson LQ.

**Plotters:** (HPGL), HP74XX, 75XX, 7475A, and ColorPro.

## DATA TRANSFER

**Formats:** Binary, ASCII, TIFF, PCX, HPGL, Spreadsheet, P-Spice, MathCad, BMP.

**Maximum block transfer speed:** 200 kbytes/sec.

## GPIB UTILITY SOFTWARE

GTALK Software for IBM PC compatible computers with National Instruments GPIB PC2, PC2A, or PC-AT GPIB Cards. This software utility sends and receives commands on the GPIB bus.

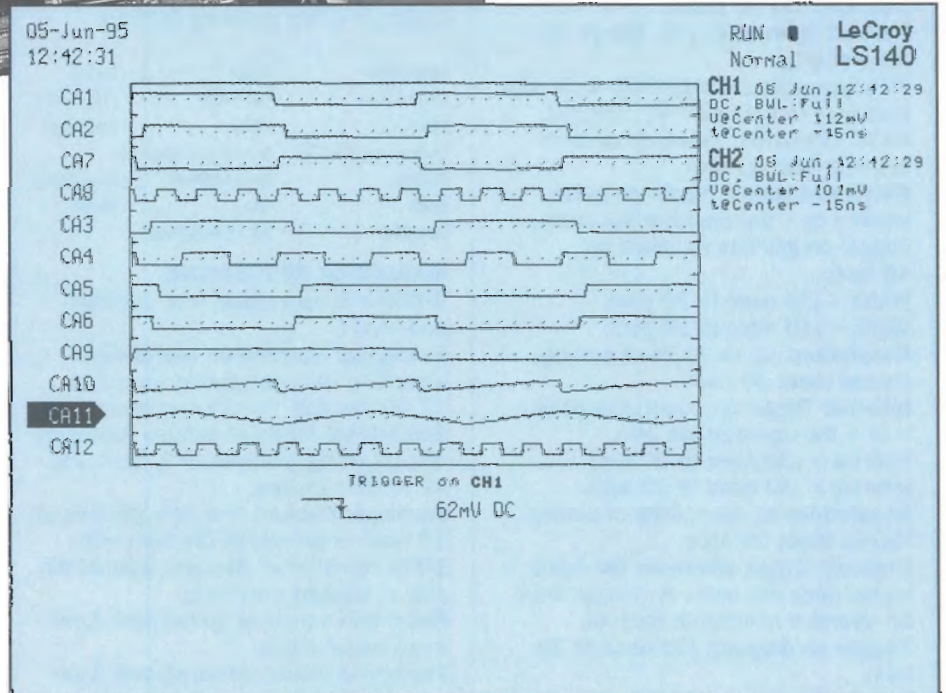
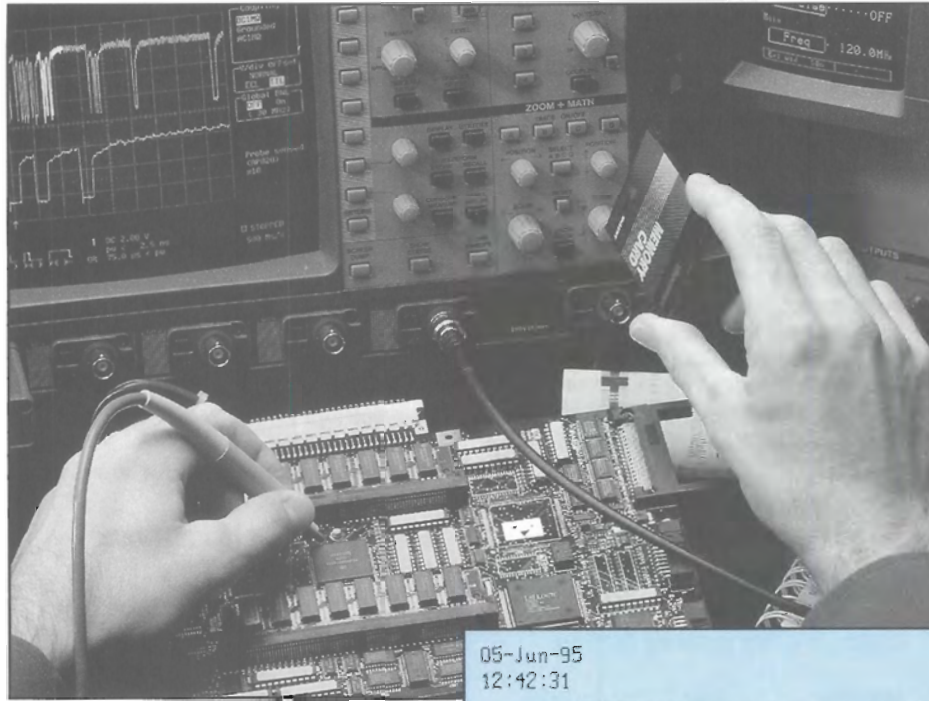

The LS140 can show a cascade display with 12 or 24 traces. This is very useful for checking the timing of a variety of signals.



## LS140 Series

Model #	LS140 Series Digital Oscilloscopes	U.S. \$
LS140	4 Ch 100 MHz 200 MS/s Scope	4,200
LS140-L1	20k Memory and 100 MByte Hard Disk LS140 option at time of purchase	795
LS-GPIB	GPIB Interface for LS140 IEEE-488.2 and SCPI compatible	500
<b>Accessories</b>		
LS-RM	Rackmount Adapter for LS140	340
LS-RS232/PLOT	RS232 Cable LS140 to Printer/Plotter Connects LS140 to DTE device	50
LS-RS232/REM	RS232 Cable LS140 to IBM AT Computer 9 Pin Female to 9 Pin Female Connector	80
LS-SOFT	Soft Carrying Case for an LS140	199
LS-TRANS	Transit Case for LS140	570
OC9002	Oscilloscope Cart for 9300, 9400 and LS140 Series Compatible with FD/GP Option for 9300	555
OC9003	Oscilloscope Cart with Drawer and Printer Shelf	795
<b>LS140 Series Probes</b>		
PP050	10:1 Scope Probe for LS140	75
PP051	10:1 Smart Probe for LS140	175
<b>Warranties &amp; Calibrations</b>		
LS-CC	NIST Calibration on an LS140 at time of purchase	175
LS-C5	5 NIST Calibrations on an LS140	495
LS-CM5	5 MILSTD Calibrations on an LS140 MILSTD 45662A	995
LS-EW	One Year Extended Warranty - Includes NIST Calibration	350
LS-MIL	MILSTD 45662A Calibration on an LS140	275
LS-T5	5 Year Warranty & NIST Calibration on an LS140	850
LS-W5	5 Year Warranty on an LS140	500

# 1-800-5-LECROY

LS140 Series Ordering Information





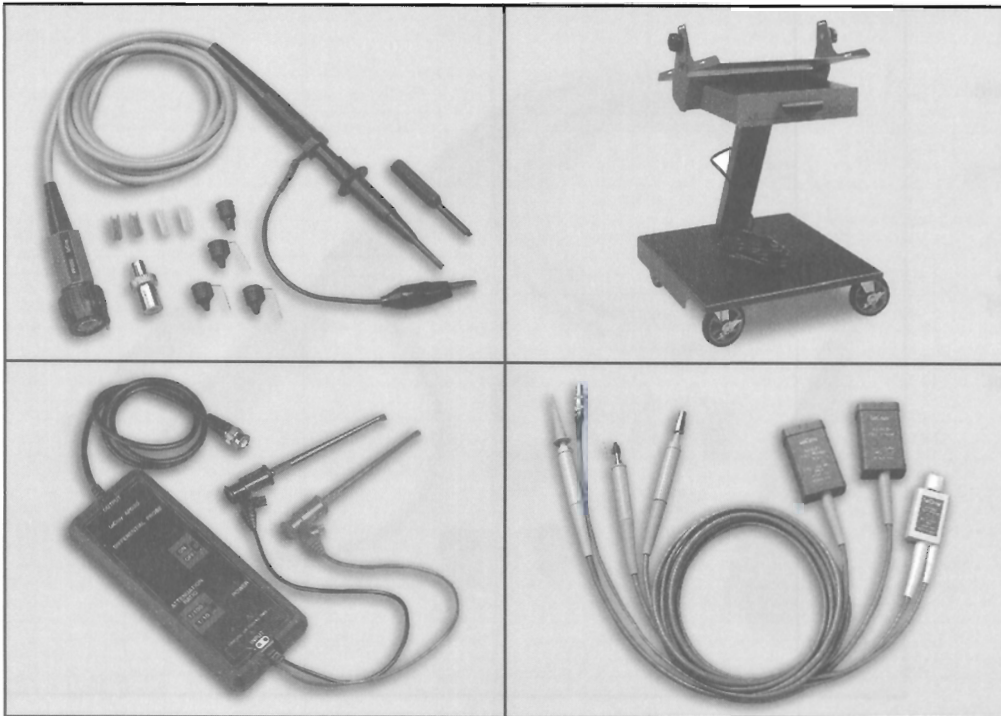

#### ADJUSTMENTS

Frequency compensation on the high impedance probes is accomplished through the use of adjustment screws on the probe heads. All LeCroy digital oscilloscopes provide a calibration output on their front panel for this adjustment. The LeCroy 9300 Series provides internal capability of adjusting both the amplitude and frequency of the calibration output to suit user preferences. The output is applied to a front panel BNC, and a BNC-to-probe tip adapter is supplied in each probe kit.

#### WHEN TO USE A FET PROBE

The most commonly quoted specifications of passive probes are their bandwidth, impedance and capacitance. In fact, all three characteristics are related. The capacitive reactance (impedance in ohms) of a passive probe is related to the input frequency and probe capacitance by :

$$R = \frac{1}{2 \pi FC}$$

Where R is the capacitive reactance (in ohms) at an input frequency F for a probe with capacitance C. As an example, a 10 Mohm passive probe with 11 pF capaci-

tance is supplied by one major scope vendor who rates its performance as 500 MHz at the probe tip. But in a separate document the vendor also correctly points out that the capacitive reactance of this probe is only 290 ohms at 50 MHz. For signals of 50 MHz and above this probe is not the best tool.

LeCroy offers three solutions to this problem. The PP004 10 Mohm probe supplied standard with the 9370 series scopes has a low (< 6pF) capacitance. Or if your circuit can drive 500 ohms, the PP 063 has < 0.5 pF capacitance and 8 GHz bandwidth. The most common tool for high speed designers is the active (FET) probe. LeCroy offers 800 MHz and 1 GHz active probes which present the circuit under test with a low capacitance, high impedance load. The model AP 021 and model AP 020 probes are very reasonably priced and acquire their power from the oscilloscope via the ProBus connection which is integral to the scope.

## Digital Oscilloscope Probes

### Main Features

- Bandwidths from 10 MHz to 8 GHz
- Attenuation from 1X to 100X
- Input rise times as low as 58 psec
- New "SMART" probes now available

LeCroy digital oscilloscopes are provided with one probe for each input measurement channel. Each probe comes high frequency compensated to match the oscilloscope with which it is supplied.



## Selection Guide

### PASSIVE PROBES

LeCroy Digital Oscilloscopes are provided with a complete set of passive probes. In order to provide the best possible pulse and frequency response, each passive probe is adjusted to match a specific oscilloscope.

- 1 Smart Probe: Allows up to three separate actions to be controlled right from the probe.
- 2 Equipped with SMA connector.
- 3 Mini Probe: The ideal probing tool for fine pitch integrated circuits.

### Compatibility:

- 1= 9310/04/14
- 2= 9320/24
- 3= 9360/61
- 4= 9350/54, 9350A/54A, 930xA/931xA
- 5= 94xx
- 6= 7200/7200A
- 7= LS140
- 8= 9310A/04A/14A
- 9= 9362

### THE SMART PROBE

The ScopeStation 140 oscilloscope includes four PP050 x10 passive probes. The PP051 Smart Probe is available as an option. The SMART

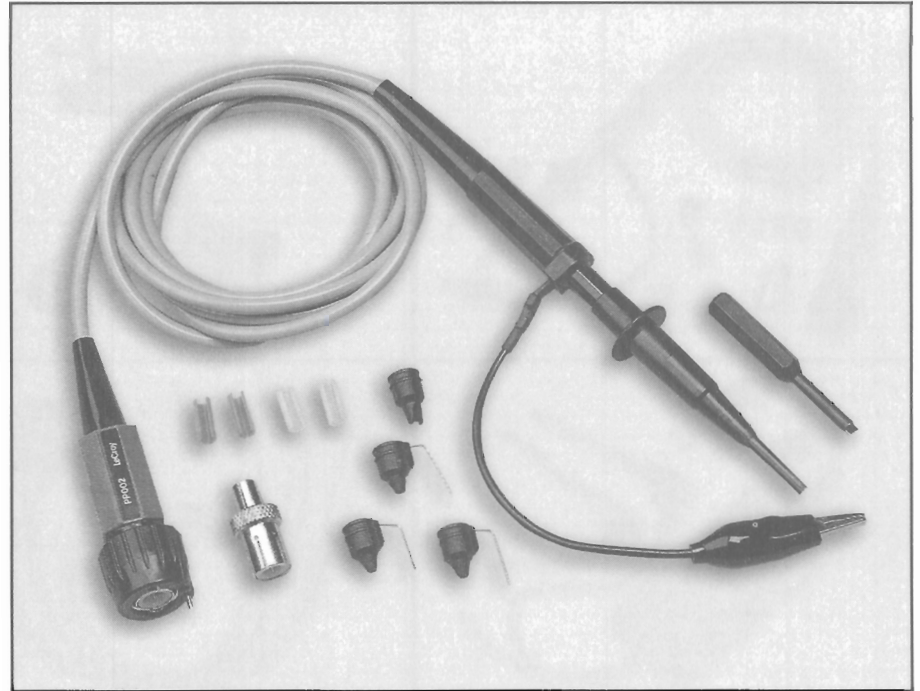

The following selection tables provide basic specifications for the range of probes and the oscilloscope model which they are to be used.

probe provides fingertip control over common front-panel operations. You never need to take your hands off the probe to change a setting, freeze the display, or plot a hard copy. For example, with the Smart Probe it is faster

and easier to create a "cascade" display on the DSO, whereby different probe points measured in this fashion represent individual traces on a common display. In this way, digital troubleshooting measurements that

### Passive Probes Selection Guide

Types	Bandwidth MHz	Input Z $\Omega$	Input C pF	Attenuation	Maximum Voltage VDC + Peak AC	Probe Ring	Compatibility
PP 002	350	10 M	14	10:1	600	YES	1; 3; 4; 5; 8
PP 004	500	10M	<6	10:1	600	YES	1; 3; 4; 5; 8
PP 011	300	10 M	4	100:1	1000	NO	1; 5
PP 012	300	10 M	4	100:1	1000	YES	1; 3; 4; 5; 6; 8
PP 050	150	10 M	18	10:1	600	YES	7
PP 051	150	10 M	18	10:1	600	YES	7
PP 062	1000	500	1.5	10:1	22	YES	1; 2; 3; 4; 5; 6; 8; 9
PP 063	8000	500	< 0.5	10:1	10	NO	2; 3; 4; 6; 8; 9
PP 064	1000	5 K	1.3	100:1	30	YES	2; 3; 4; 6; 8
7200-P 12	350	10 M	14	10:1	600	YES	6

For Ordering Information See Page 64



normally require multiple channels of a scope or logic analyzer can be accomplished with one input and one probe. With a Smart Probe, the user can move the probe from one test point to the next. A softkey located at the tip of the probe can cause the information from each signal to be plotted on successive traces of the cascade display. Another use for the Smart Probe is to semi-automate a test procedure. Each touch of the softkey at the probe tip can cause the data from the current test point to be saved (to floppy, hard drive, etc.), advance the setup of the LS140 for the next test point and put a message on the screen telling the user that the current test point was OK and to move the probe to the next test point.

### THE LECROY PROBUS SYSTEM

The ProBus system provides a complete measurement solution from probe tip to oscilloscope display. ProBus is an intelligent interconnection between LeCroy oscilloscopes and a growing range of innovative probes. ProBus provides automatic sensing of the probe type. For LeCroy's FET probes, it also allows offset at the probe tip and coupling to be controlled from the scope front panel. With ProBus, autoseup is performed at the probe tip.

Communications between oscilloscope and probe are provided by a 6 pin connector carrying I2C protocol.



Application specific devices such as attenuators, amplifiers, impedance adapters etc. can also be integrated into the ProBus concept. Attenuation or amplification factors are automatically taken into account by the oscilloscope so the user is protected against measurement errors.

### FET PROBES

FET probes extend the measurement capabilities of any oscilloscope. They provide higher resistance and lower capacitance than passive probes. The reduced load on the circuit being probed results in more accurate measurements. FET probes are the ideal tool for working on sensitive or high-speed electronics.

FET Probes								
Model Number	Bandwidth MHz	Input Z MΩ	Input C pF	Attenuation	Dynamic Range V	DC Offset Range V	ProBus	Compatibility
AP 003 AP 060	DC to 1000	1	1.9	10:1 ±2%	±7	N/A	NO	9304/10/14 94xx/LS140 7200/7200A
AP 020	DC to 1000	1	1.8	10:1 ±2%	±5	±20	YES	9304A/9310A 9314A/9320/9324 9350A/9354A 9360/9361/9362
AP 021	DC TO 800	1	2.7	5:1 ±2%	±2.5	±10	YES	9304/9310A 9314A 9320/9324 9350A/9354A 9360/9361/9362

For Ordering Information See Page 64

**DIFFERENTIAL PROBES**

The AP030, SI 9000 and SI 9000A are active differential probes. The differential techniques employed permit measurements to be taken at two points in a circuit without reference to ground.

This allows the oscilloscope to be safely grounded without the use of opto isolators or isolating transformers.

The two signals are processed in the probe and the resultant output is fed to a single channel of the oscilloscope. The output from the probe is a coaxial cable equipped with a standard BNC connector.

The probes are compatible with all 1 M $\Omega$  input oscilloscopes.

The following table gives key specifications for LeCroy differential probes. Further information is provided in the technical data sheets.



Differential Probes								
Model	Bandwidth MHz	Input Z M $\Omega$	Common Mode Rejection Ratio		Attenuation	Maximum Input Voltage DC + Peak A		
			50 Hz	1 MHz		Diff. V	Com. mode V	Abs. max V
AP 030	DC to 15	2	-90	-53	10:1 100:1	$\pm 40$ $\pm 400$	420 420	1000 1000
SI 9000	DC to 15	2	-80	-45	20:1 20:1	$\pm 70$ $\pm 700$	700 700	1000 1000
SI 9000A	DC to 15	2	-80	-45	50:1 500:1	$\pm 100$ $\pm 1000$	1000 1000	1000 1000

**PROBE ACCESSORIES**  
**GENERAL PURPOSE**
**D 901X: 10:1****HIGH IMPEDANCE DIVIDERS**

The D 901x plugs directly onto the input BNC of the scope in 1M $\Omega$  configuration, and is compatible with the models listed below. Most DSO attenuation factors include a setting for 10000:1, making it possible to use the D 901x and a suitable 1000:1 probe at sensitivities of over 10,000 volts/division.

**Model Compatibility**  
**D 9010**
**D 9011**  
**D 9012**  
**D 9013**
**Oscilloscope Model**

9420, 9424, 9450, 7200's  
9410, 9414, 9430  
9450A  
931x, 935x, 9360, 9361, 937X





## SG 9001: OVERVOLTAGE INPUT PROTECTOR

Assembled in a BNC feedthrough housing, Model SG 9001 protects the high impedance scope input circuitry from voltage signals exceeding 230V. It is a spark gap protection device, which adds negligible capacitance to the input, thus ensuring clean signal measurement.

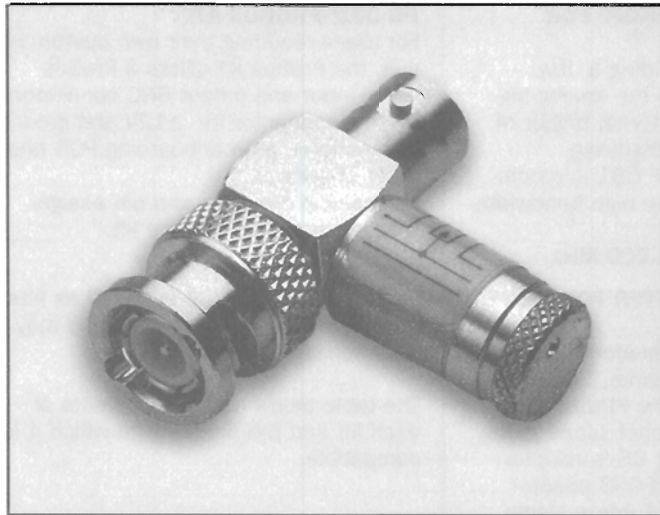

## AP 501: PROBE POWER SUPPLY

Provides external power for LeCroy's AP 003 FET Probe. It is not required for AP 020 or AP 021, which are powered directly via ProBus.

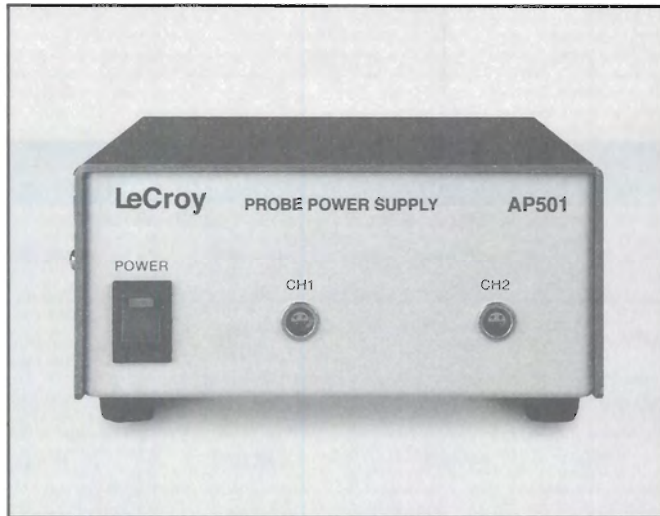

## PROBUS

### PP 090: 75 TO 50 OHM PROBUS ADAPTER

Used with any ProBus-compatible scope input, provides 75Ω input impedance. Gain compensation is performed automatically by the oscilloscope. Primary applications include telecommunications and video.

**Input Impedance:** 75 Ω ± 1%

**Atten.:** 2:1 ± 1%

**Max. Input Voltage:** ± 8.66 V DC (1 W)

**VSWR:** (DC to 1 GHz), <1.1 typical.



**PP 091: TRIGGER PICKOFF FOR MODEL 9360**

A ProBus adapter providing a low capacitance pick-off of the analog signal for use with the external trigger of Model 9360, 5 GS/s Digitizing Oscilloscope. Model PP 091 is recommended when using the high bandwidth input of Model 9360.

Insertion loss : 1dB at 600 MHz

**PP 092: 2GS/S ADAPTER FOR MODEL 9354**

The PP 092 Adapter transforms Model 9354 into a single channel, 2GS/s Digital Oscilloscope. The PP092 is supplied with every 4 channel scope in the 9354 family. PP093: 2 GS/s adapter for Model 9374. The PP093 adapter transforms model 9374 into a single channel 2 GS/s digital scope. It is supplied with every 9374, 9374M and 9374L.

**PB 001: PROBUS KIT**

For users requiring their own custom circuit, the ProBus kit offers a ProBus case, input and output BNC connectors, ProBus connector for  $\pm 12V$  and ground connections, a breadboarding PCB and a set of screws.

Mechanical drawings and pin assignments are provided in the kit.

**PROBE KITS**

Probe accessories are supplied as kits for the various probe models and may be purchased separately.

The table below lists the contents of each kit and the probes with which it is compatible.

Probe Kits					
LeCroy ORDERING No.	PK 001	PK 002	PK 003	PK 004	PK 005
PROBE COMPATIBILITY	PP 001 PP 002	PP 011 PP012	PP 061 PP 062 PP 064	AP 020 AP021	AP 060
RETRACTABLE PINCHER TIP	PF 059	PF 004	PF 059	PF 135	PF 135
GROUND LEAD	PF 061	PF 060	PF 061	PF 060	PF 060
BNC ADAPTER	PF 017	PF 010	PF 017	PF 095	PF 095
GROUND BAYONET	PF 015 (3X)	PF 0008 (3X)	PF 015 (3X)	PF 015 (3X)	PF 015
IC TIP	PF 016	PF 009	PF 016	PF 016	PF 016
MINI PINCHER LEAD				PF 063	
MINI PINCHER (RED)				PF 082	
MINI PINCHER LEAD GND					PF 099
MINI PINCHER (BLACK)					PF 080
COLOR TAG ORANGE	PF 001 (2X)	PF 001 (2X)	PF 001 (2X)		
COLOR TAG WHITE	PF 003 (2X)	PF 003 (2X)	PF 003(2X)		
SCREW DRIVER	PF 094	PF 094			



## INSTRUMENT CARTS

Oscilloscopes and Signal Sources can be easily transported around the laboratory on instrument carts which roll on large locking castors.



**OC9002:**  
For 9400 or 9300 Series & LeCroy ScopeStation LS140.

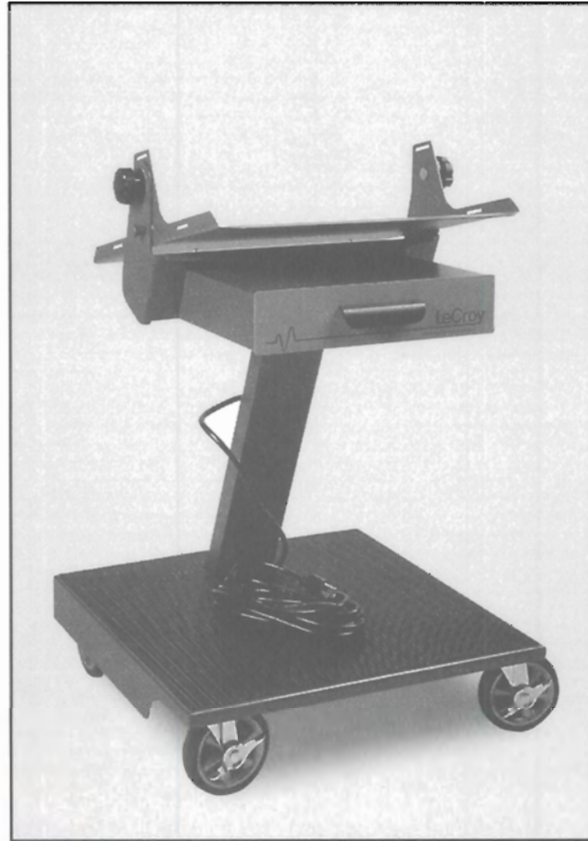

**OC9003**  
For 9300 Series Digital Oscilloscopes.  
Includes printer shelf. Also compatible with LW420.

## TRANSIT CASES

LeCroy transit cases are made of a heavy duty reinforced aluminum. Light weight and measuring approximately 30 x 50 x 60 cm (size given for 9400 Series), these cases are ideal for transporting oscilloscopes by air, road or sea.

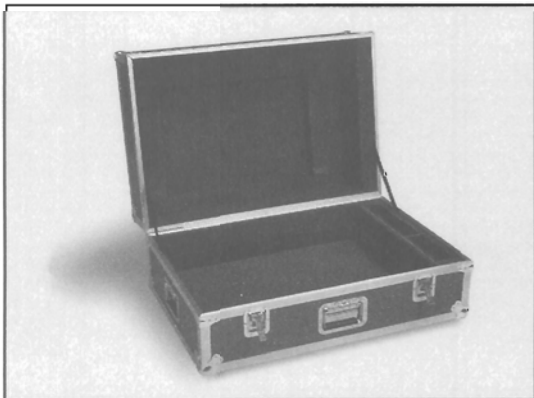

## CARRYING CASE

These soft cloth carry bags have an internal pouch for the instruction manuals and accessories. Designed for customers who use their oscilloscope in several different locations, the carry bag also acts as a protective cover.

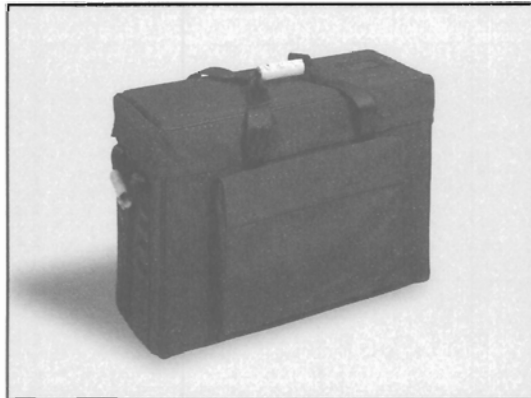





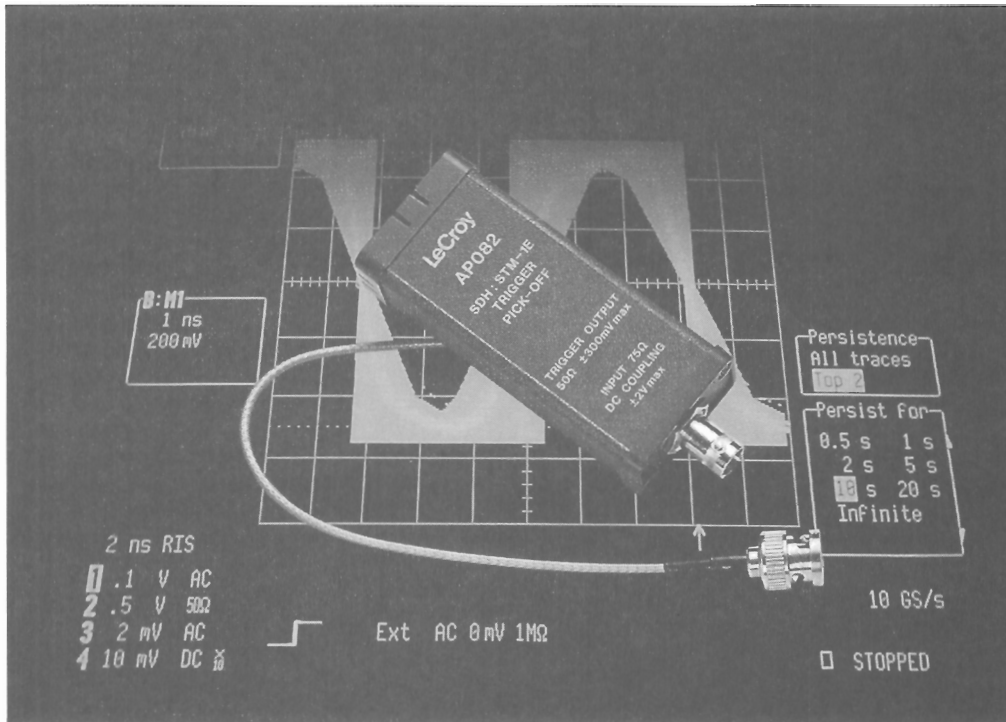

#### CHOOSE TO TRIGGER ON "0'S OR ON "1'S

155 Mbps electrical SDH and SONET signals use the CMI encoding. Using an oscilloscope to selectively trigger on the leading edge of a "1" pattern, and reject all the zeros (or vice versa) has been practically impossible until now.

Thanks to its dedicated circuitry, the AP082/083 can easily isolate either "0" or "1" patterns, allowing for further analysis such as jitter characterization or mask testing – G.703 Fig. 24 and 25 masks are supplied with the accessory.

#### ACCURATE READINGS

Both the AP082 and the AP083 have been designed to provide the correct impedance matching (50Ω for SONET and 75Ω for SDH) and because the accessory is automatically sensed by the oscilloscope, the amplitude readings are correctly scaled on screen.

#### HIGH BANDWIDTH

In addition, the accessory's high bandwidth makes it suitable for testing with an oscilloscope of 1 GHz or greater bandwidth, to minimize attenuation and distortion, and to comfortably analyze the signal well beyond its 5th harmonic.

#### AP082

**Bandwidth (3 dB):** 1 GHz  
**Input range:** ±2V  
**Input coupling:** DC  
**Input impedance:** 75Ω  
**Trigger output impedance:** 50Ω  
**Trigger output range:** ±300mV

#### AP083

**Bandwidth (3 dB):** 1 GHz  
**Input range:** ±2V  
**Input coupling:** DC  
**Input impedance:** 50Ω  
**Trigger output impedance:** 50Ω  
**Trigger output range:** ±300mV

## AP082/ AP083 Trigger Pick-off for SDH: STM-1E and SONET: STS-3

### Main Features

- AP082 for SDH, AP083 for SONET
- Ideal for pulse mask-testing
- Works with scrambled or live data streams
- Automatic impedance matching and scaling
- ProBus™ design, automatically sensed by the 93XX oscilloscopes
- Includes ready-to-load G.703 test masks





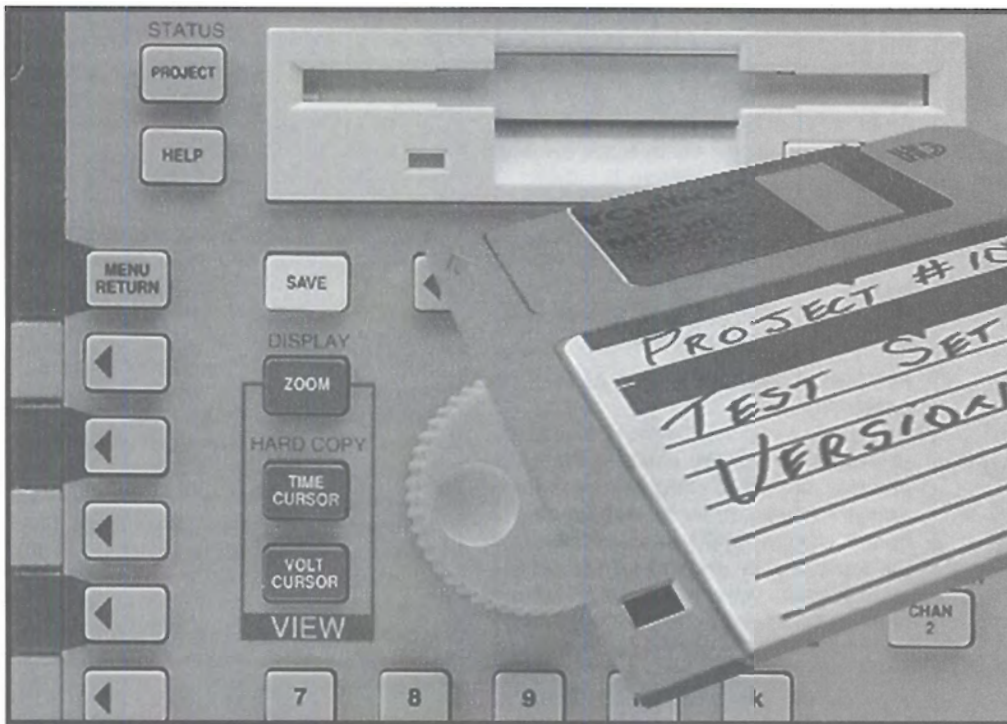

## What is an Arbitrary Waveform Generator?

The Arbitrary Waveform Generator (AWG) is a signal source that uses digital techniques to produce user specified custom analog waveforms. You might think of it as a digital oscilloscope operating in reverse. The shape, pattern, and harmonic content of the waveform to be generated are defined by a sequence of numeric values loaded into a high speed waveform memory. Each successive memory location contains a value proportional to the amplitude of the waveform point to be generated. A high precision programmable time base is used to clock the memory address counter which loads the next value to be output into a digital-to-analog converter (DAC). This produces an analog equivalent to the numeric waveform description. Like other digitally synthesized signal sources, it is characterized by high accuracy, stability, repeatability, and ease of control. The distinctive benefit of an arbitrary function generator is the ability to produce structurally complex waveforms as well as standard sine, square, and triangle waves.

### GENERATES MULTIPLE PERIODIC WAVEFORMS

Many users, like the telecommunications and medical electronics industries, need to generate waveforms which use multiple periodic waveforms with accurately controlled harmonic amplitude and phasing.

These complex waveforms are readily generated using the AWG.

### SIMULATES RANDOM OR INFREQUENT SIGNALS

Another class of applications involves duplicating signals upon demand, that are the results of random or infrequent events. Electromagnetic pulse (EMP) susceptibility testing and power line transient testing are common examples. Such transient events can be specified by equation or captured using a digital oscilloscope. Once the waveform file describing the transient waveform is generated, it can be used when and where needed.

### PRECISELY CONTROLS AMPLITUDE AND PHASE

Other applications make use of the AWG's precise control of amplitude or phase. Radar, sonar, and radio navigation test signals are all phase sensitive. Arbitrary waveform generators with dual outputs are especially well suited for producing outputs with controllable phase differences. AWG's with synchronous digital outputs provide phased digital inputs directly to radar signal processing circuits at high, operational data rates. Magnetic peripherals like disk and tape drive testing require selective control of signal amplitude or timing a specific point within the waveform. Dual channel outputs can be added or subtracted to produce amplitude or timing variations at the desired points within the waveform for tolerance and margin testing.

## Arbitrary Waveform Generators

### Main Features

- Create real world waveforms to perform realistic tests
- Move signal edges in increments as small as 100 psec to simulate signal jitter
- Change the amplitude, risetime or phase of a signal easily by turning a knob. Observe in real time how these changes affect circuit performance
- Store multiple test waveforms on an internal hard drive from which they can be rapidly recalled for high production throughput

**SHOULD YOU BE USING AN AWG?**

The examples cited are samples of a broader range of applications which would benefit from the use of an AWG as a test source. You should consider an AWG if your test signal requirements fall into any of the following categories:

- You're using "hot mock-ups", "golden reference" assemblies, or custom designed generators to supply real signals.
- You must test with signals that occur rarely, or unpredictably.
- You have to supply signals that originate in parts of a system that are unavailable or are hard to control.
- You have to supply multiple waveform types that would require many different signal sources.
- You need mixed analog and digital test signals.

**When Choosing an AWG, Be Sure to Consider the Following:****EASE OF WAVEFORM CREATION**

As the use of AWGs is a relatively new concept, it is extremely important to choose one that offers convenient user interaction. The LW400 series allows users to create and control waveforms "live" by turning knobs on the front panel while viewing the signal on a built-in 9" CRT. Its features include very easy waveform creation methods, file management, waveform transfer from LeCroy's digital scopes and DSOs from other vendors. You can also download data files from P-Spice, MatLab, MathCad and other programs directly into the LW400 Series.

**SUFFICIENT AND NON-VOLATILE WAVEFORM STORAGE MEMORY**

Recalling stored waveforms from memory is faster than recreating them from equations or externally downloading them when you want to change output waveforms. In LeCroy AWGs, non-volatile memory stores waveform data, setup files, and macro-command sequence files, which are all used for quick, automated AWG operations. The LW400 AWGs come with 256 kbytes of memory standard. Configurations of up to 1 million bytes are offered.

**DC ACCURACY**

DC accuracy is a measure of how precisely an AWG can provide the fundamental output voltage upon which all other smaller dynamic inaccuracies piggyback. It is important to focus on this attribute, and then analyze the overshoot, ringing, rise time, settling time, and harmonic distortions that can adversely affect the fidelity of your waveforms. LeCroy AWGs emphasize this specification, offering <math>-50\text{dB}</math> typical total harmonic distortion.

**PRECISE SIGNAL CONTROL AND CONDITIONING**

One of the most important characteristics of an AWG is the ability to make precise, controlled shifts in waveform timing and amplitude. An outstanding benefit of the LW400 series design is the EASY way in which the user can control signal edge and feature placement in 100ps increments. Output signal conditioning is optimized through an amplifier/attenuator/filter section that provides the signal you need without complex programming. Competitive instruments force the user to set waveform lengths in 32 point increments, but in the LW400 the customer gets what he wants - single point resolution.

**DUAL CHANNEL OPERATION**

In the LW420, two independent channels operate from a common timebase, providing precise phase synchronization as well as simultaneous, dual-function operation. You can use the two channels to generate different but time-related signals, or you can sum the signals from both channels into one output.



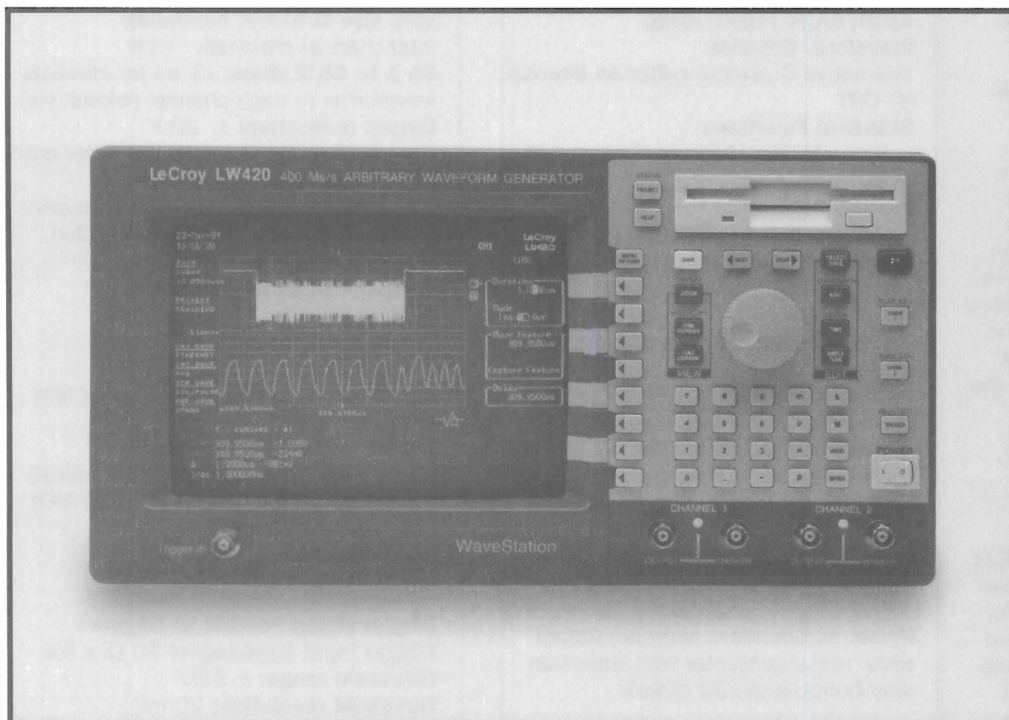

## Features and Benefits

The WaveStation, LW420, is a dual channel, 400 MS/s arbitrary waveform generator (AWG) that redefines what high performance AWG's are, and how they will be used. WaveStation offers more than just improved technical specifications, it substantially increases functionality and ease of use, eliminating many of the traditional obstacles constraining previous AWG's. Building on over 7 years of experience in the design and manufacture of high performance signal sources, the LW420 combines innovative signal processing, high speed electronic design, and human factors engineering to provide a truly intuitive and highly interactive arbitrary waveform generator.

### **SPECIFY THE WAVEFORM, LET THE LW420 WORRY ABOUT THE DETAILS**

The WaveStation does not require the user to be aware of the sample clock period or the particular reconstruction filter being used. All the LW420 needs to know is your waveform in terms of voltage and time. No matter which of the many available tools you use to specify the waveform, the LW420 will generate the output using the optimum combination of sample clock rate and filter bandwidth. The filters used will assure that aliasing does not take place and that all the timing relationships within the waveform will be precisely maintained.

### **LIVE WAVEFORM MANIPULATION LET'S YOU CONTROL THE WAVESHAPE QUICKLY AND INTERACTIVELY WHILE BEING DISPLAYED ON THE INTERNAL CRT DISPLAY**

Select a section of the waveform using the time cursors, then select one of a set of waveform manipulation operations (e.g. move feature, delay, amplitude,...) and turn the knob! That is how easy it is to continuously modify all or part of a waveform. Time shifts, as small as 100 ps, amplitude variations on a peak, or changes in signal duration are instantly reflected in the output signal. Margin testing or characterization, with the most complex waveforms, has never been so simple.

### **WAVEFORM CREATION HAS NEVER BEEN EASIER**

Waveforms can be selected from libraries of traditional function generator waveforms. They can also be created using equations or imported from external sources such as oscilloscopes or other computer programs. Waveforms, once created or captured, can be further manipulated using the internal waveform (array) math processing. The waveform math functions include basic arithmetic operations, smoothing, integration, differentiation, and convolution.

A highly developed waveform editing capability uses advanced signal processing to provide bandlimited cut, paste, insert and offset operations with minimum editing artifacts. Single sample resolution eliminates the constraint found in other AWGs that waveforms be multiples of 8 or even 32

## LeCroy WaveStation LW410/LW420 Arbitrary Waveform Generator 400 MHz Sample Clock

### Main Features

- 100 ps feature placement resolution
- 400 MS/s maximum sample clock per channel
- 1 and 2 channel versions
- Live update of waveform output
- Built-in display
- Stand Alone Design, no PC required
- 8 bits of vertical resolution
- Up to 1 MByte of playback waveform memory per channel
- Internal 130 MByte hard disk drive for project, sequence, and waveform storage (>400 MByte optional)
- Built-in Floppy Disk Drive for waveform and sequence file transfer and storage
- Digital Outputs optional



samples further simplifying the waveform creation process.

#### PULL WAVEFORMS DIRECTLY FROM MOST DIGITAL SCOPES

Connect a GPIB cable between the LW420 and your digital oscilloscope. Select your scope from a list of commonly available scopes. Then simply touch a softkey to select the trace on the oscilloscope that you would like to transfer to the AWG. That's all you need to do. Once in the WaveStation all the manipulation, editing and math tools can be used to put the waveform in the shape you need for your task.

#### 400 MS/S MAXIMUM CLOCK RATE, 1 MBYTE WAVEFORM LENGTH, SYNTHESIZER TIMEBASE MEANS BETTER PERFORMANCE

A maximum sample rate of 400 MS/s combined with up to 1 MByte of waveform memory gives you the raw performance you need to generate the most demanding, complex stimuli. The timebase combining 3 ppm accuracy and 1ppm/year stability assures that the waveforms you test your systems with next year will be the same as the ones you use today. Low single sideband phase noise of less than -110 dBc/Hz @ 10 KHz from a 10MHz carrier and a 1 Hz frequency resolution mean that the LW420 can be used to generate even the most demanding communications waveforms.

#### FULLY INTEGRATED AWG INCLUDES HIGH PERFORMANCE PROCESSOR, INTERNAL HARD DISK DRIVE, AND BUILT-IN 9 INCH CRT

WaveStation provides all the power needed to work with long and complex waveforms. A built-in 130 MByte hard disk drive, a 33 MHz 486 processor, up to 20 MByte of RAM, and an internal monochrome VGA display make the LW420 a fast and responsive instrument ideally suited for interactive graphical operations required in a high performance AWG.

#### Performance Specifications

##### GENERATOR MODE

##### Standard Function Waveforms

DC  
Sine, 1 Hz - 100 MHz  
Square, 1 Hz - 50 MHz  
Triangle, 1 Hz - 25 MHz  
Ramp, 1 Hz - 25 MHz  
Pulse, (period)10 ns - max. memory  
Frequency Sweep Linear / Log  
Multitone, 1-10 tones, 1 Hz - 100 MHz

##### ARBITRARY FUNCTIONS:

##### Waveform Creation

Interactive Graphical editor on Internal 9" CRT

##### Standard Functions

Sine, Square, Triangle, Ramp, Pulse, DC

##### Equation Editor

Waveform (array) Math

##### Waveform Import From

Digital Oscilloscope  
Floppy Disk

##### Waveform Feature Time Resolution:

100 ps

**Available memory:** 256k/ch. standard, 1 Mpoint optional

**Minimum segment length:** 64 points

**Maximum segment length:** Up to available memory (1Mpoint when optional memory installed)

**Segment length resolution:** 1 point

**Number of links:** 512 for 256k memory 2048 for 1M memory

**Noise:** Independent pseudo random white noise generator with Gaussian distribution and 232 states

##### WAVEFORM OUTPUT CHARACTERISTICS

**Output channels:** LW410 - 1 Channel  
LW420 - 2 Channel

**Output Impedance:** 50  $\Omega$ ,  $\pm$  5%

**DC Accuracy:** 2% of setting + 40 mV

**Vertical resolution:** 8 bits

**Minimum output voltage:** 10 mV p-p into 50  $\Omega$

**Maximum output voltage:** 10 V p-p into 50  $\Omega$

**Offset voltage range:**  $\pm$  5 V into 50  $\Omega$ . The output voltage (signal + offset) must be in the range  $\pm$  5 V into 50  $\Omega$ . Offset limited for smaller amplitudes as follows:

**Offset voltage resolution:** 0.05% of full scale

**Output bandwidth:** 100 MHz (-3dB) (widest bandwidth)

**Total harmonic distortion:** <5 V p-p <-45 dBc (-50 dBc typical) for sinusoidal output  $\leq$ 1MHz

<-35dbc for sinusoidal output 1 MHz to 20 MHz (<-45 dBc typical)

<-25 dBc to 50 MHz (<-40 dBc typical) (predominantly 2nd harmonic)

**Spurious & non-harmonic distortion:** <-60 dBc for frequencies  $\leq$ 1 MHz for output

**Signal-to-noise ratio:** >40 dB (-45 typical) for output amplitudes >100 mV @ 0 offset

**Transition times:** <6 ns 10%- 90% @ widest bandwidth

**Overshoot and ringing:** <8% of step size max. 3% typical

**Settling time:** <50 ns to within 2% of

step size @ widest bandwidth

Inter-channel crosstalk: <1%

**Ch 1 to Ch 2 skew:** <1 ns for identical waveforms in each channel (widest bw)

**Output protection:**  $\pm$  20 V

**Output filtering:** The following filter cut-off frequencies are available;

100 MHz Gaussian, 10 MHz Gaussian, 1 MHz Gaussian, 100 kHz Gaussian, 10 kHz Gaussian

**Sample clock characteristics:** (with internal 10 MHz reference)

**Maximum sample rate:**

400 MS/second

**Accuracy:** <3 ppm over operating temperature range

**Stability:** aging <1 ppm/year

**SSB Phase Noise:** <-110 (-115 typical) dBc/Hz @ 10 KHz offset for a 10 MHz sine wave at the output

**Resolution:** 1 Hz

##### TRIGGERING CHARACTERISTICS

**Trigger slope:** Positive or Negative

**Trigger input impedance:** 50  $\Omega$   $\pm$  5%

**Threshold range:**  $\pm$  2.5V

**Threshold resolution:** 20 mV

**Threshold accuracy:** 100 mV

**Threshold sensitivity:** 50 mV p-p

**Minimum pulse width:** 5 ns

**Protection:**  $\pm$  5 V

##### TRIGGER MODES

**Continuous:** Runs continuously

**Single:** Outputs 1 repetition of the waveform for each trigger received.

Triggers received while the waveform is still running are ignored.

**Burst:** Outputs the selected waveform a programmable number of times in response to a trigger. The maximum number of repetitions for a burst is 4,095. Triggers received while the burst is running are ignored.

**Gated:** The waveform starts on the leading edge of the gate signal and stops on completion of the waveform cycle occurring at the trailing edge of the gate signal.

##### TRIGGER DELAY

**Minimum delay time:** 35 ns  $\pm$  3.5 ns +5 sample clocks

**Maximum delay time:** (232-1) sample clocks

**Delay resolution:** 1 sample clock. The delay will be programmed in units of seconds. When operating from the front panel the resolution (sample clock period) will be shown to the user and the delay will change in increments of that value.

**Delay accuracy:** Same as sample clock + minimum delay time

**Delay jitter:** 1 sample clock



**TRIGGER SOURCES****Manual:** Front panel pushbutton**External:** Front panel BNC connector **GPIB:** A trigger command may be issued over the GPIB bus**AUXILIARY INPUTS****External:** 10 MHz reference A rear panel input is provided that allows an external reference clock to be input. 400 mV p-p to 5 V p-p into 50  $\Omega$ .**AUXILIARY OUTPUTS****10 MHz reference output****Timing marker:** 1 bit of memory up to 128 transitions definable**Output levels:** ECL or TTL levelsProtection: Outputs are protected to  $\pm 5$  V**Digital Output:** (optional) Channel 1 only, 8 bits and clock available from rear panel. TTL/ECL/PECL logic levels simultaneously.**Noise In/Out:** From rear panel BNC Connectors**HARD COPY OUTPUTS****Supported Printers include:**

Epson MX/FX

Epson LQ

HP LaserJet II

HP ThinkJet

**PROGRAMMABILITY**

GPIB IEEE 488.2 compatible.

Compliant with SCPI programming language. Capable of initiating and controlling waveform transfer from digital oscilloscopes by simply connecting a GPIB cable (no computer required).

**MECHANICAL****Dimensions:** 14.92" Width x  
7.67" Height x  
19.58" Depth*(37.9 cm x 19.5 cm x 49.7 cm)***Weight:** 27.6 lbs (12.5 kilograms)**ENVIRONMENTAL****Temperature:** 5° to 35° full specifications; 0° to 40° C operating; -20° to 70° C non-operating.**Humidity:** 10% to 90% relative, non-condensing**Power:** 90 - 132/180-250 V AC  
47 - 63 Hz4 amps @ 115 V AC (20 amps  
cold start surge)2 amps @ 230 V AC (40 amps  
cold start surge)

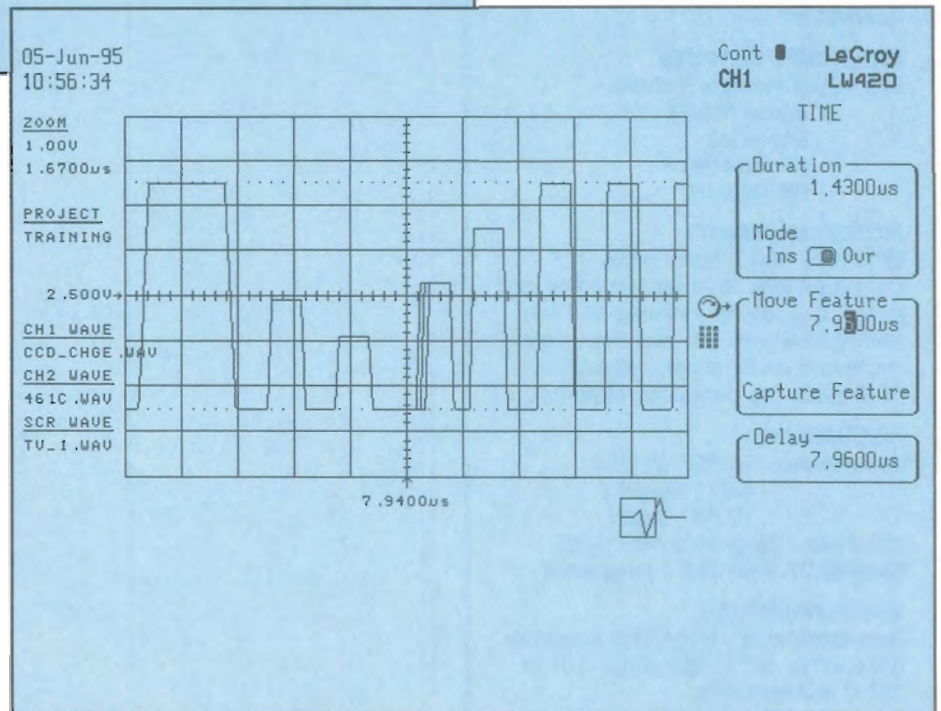
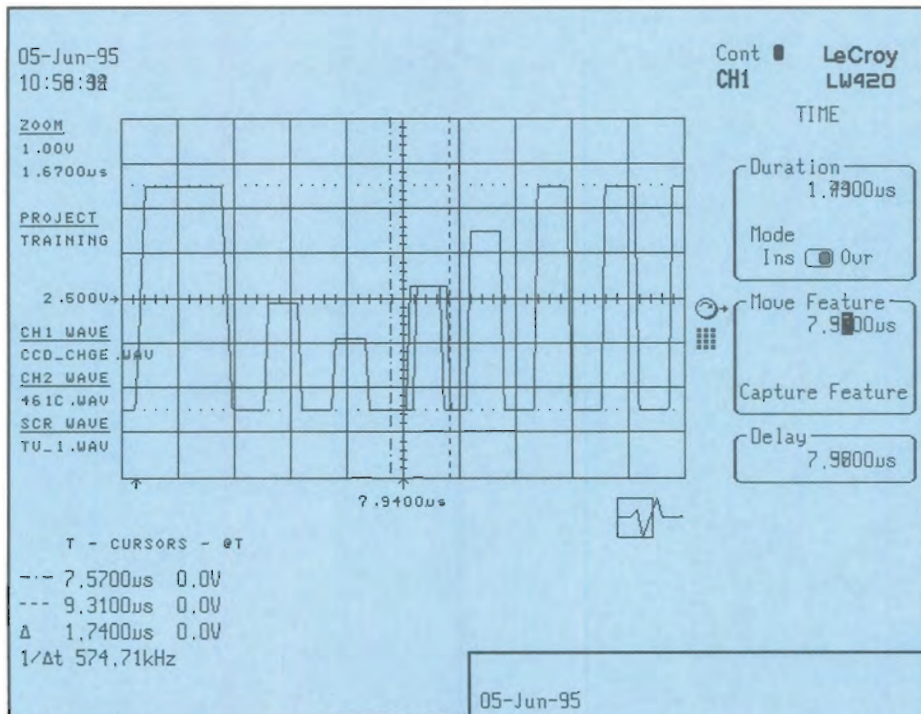

With the LW420 series it is easy to modify pulse width, risetime, falltime or to precisely move the placement of a pulse by 100 psec increments. In the top picture an entire pulse is moved while on the lower only the timing of the leading edge is changed.



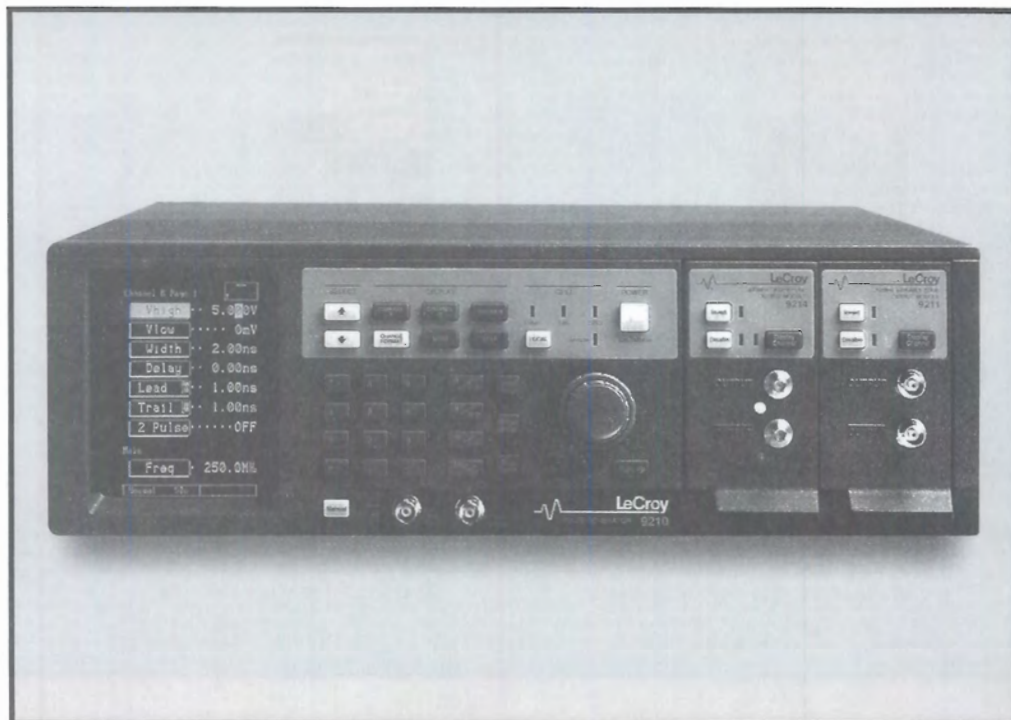

## Main Features

**Modular Architecture** - Achieves an exceptionally wide range of pulse characteristics. Output modules can be mixed in any combination within the mainframe, making future upgrades as simple as plugging in a new module.

### UNPARALLELED ACCURACY AND PRECISION

The 9210 features 10 psec resolution with  $\pm(0.5\% + 200 \text{ psec})$  timing accuracy. DC amplitude accuracy is 1%. Accuracy is guaranteed by the built-in calibration system. Automatic load compensation delivers true programmed amplitudes even with non  $50\Omega$  loads.

### EASY, INTUITIVE OPERATION -

Setting the operating parameters couldn't be easier! A bright CRT display shows all related settings at a glance. Pulse parameters and trigger settings are accessible with a single keystroke. Individual parameters are selectable from on-screen system or front-panel select keys. Displays automatically match installed modules. An on-screen graphical icon shows the pulse parameter being affected and setting conflicts are highlighted to prevent setup errors. Up to 16 setup configurations can be stored and recalled from non-volatile memory.

### CONTROL WITHOUT COMPROMISE -

Choose the data entry method you prefer, digital or analog. Use the full-featured keypad to enter parameter values with digital

precision and speed.

Use the concentric knob if you prefer the interactive analog feel. The analog knob provides both coarse range selection and vernier control, with key-selectable vernier sensitivity.

The 9210 is also fully GPIB compatible, with an easy-to-understand command set and syntax. A built-in command monitor aids in rapid debugging of your test programs.

### PLUG-IN MODULARITY

The 9210's pulse output characteristics are determined by the selection of one of three available output modules. The mainframe performs all timing, triggering, interface, and control functions. In this way, the 9210 can meet a wide range of pulse generation applications... from the large amplitude requirements of analog device characterization to the sub-nanosecond transition times required by today's fast digital IC's.

### STRAIGHTFORWARD, VERSATILE CONTROLS

- 1. Display:** Large blue keys select the display of pulse, triggering, or control parameters for adjustment.
- 2. Select:** the touch-screen CRT selects individual parameters (like pulse width) for adjustment.
- 3. Enter:** Parameter values can be quickly entered using the numeric keypad, the 1-2-5- sequence rotary ring, or the fine analog rotary control knob.

## 9200 Series, 300 MHz Programmable Pulse Generator

- Variable edge pulses (1 nsec to 1 msec) at rates to 250 MHz
- Fast 300 psec edges to 300 MHz
- Wide output swings to 32 V at pulse rates to 50 MHz
- Modular Architecture
- DC amplitude accuracy 1%
- Normal and complementary outputs
- 5 year warranty





### Model 9211

#### 250 MHz, 1 nsec output module

- 250 MHz, 1nsec output module
- Variable edged... 1nsec to 1 msec
- 5 volt swing into 50 Ohms
- Complementary outputs



### Model 9213

#### 50 MHz, 16 volt output module

- 50 MHz pulse repetition rate
- Variable edges... 6.5 nsec to 95 msec
- 16 volt p-p output into 50 Ohms
- 32 volts into high impedance



### Model 9214

#### 300 MHz, 300 ps output module

- 300 MHz pulse repetition rate
- 300 psec leading edge
- 5 volt swing into 50 Ohms
- Complementary outputs

#### HIGHEST PRECISION & ACCURACY

The 9210 uses a 12-bit ADC and a high resolution TDC to make nearly 1000 calibration measurements to guarantee timing accuracies of <0.5% and edge placement resolution to 10 psec.

#### AUTOMATIC LOAD COMPENSATION

Test fixtures and jigs can often introduce slight variations in load impedance. The load compensation capability of the 9210 delivers the programmed pulse level to any load from 47Ω to 1MΩ.

#### CONSTANT PHASE MODE

Constant Phase Mode on the 9210 maintains a constant phase relationship between two channels, even when varying the repetition rate during simultaneous clock and data simulation.

#### GPIB PROGRAMMABLE

Fully GPIB (IEEE 488.2) compatible with an easy-to-understand, plain English command set and syntax. A built-in GPIB command monitor aids in rapid debugging of automated test programs.

#### 5 YEAR WARRANTY, BY DESIGN

The 9210 Pulse Generator has a unique five year warranty. It's not an extended warranty... it's the standard warranty. The 9210 is guaranteed to meet its specs, continuously and reliably, for five full years. This type of warranty is made possible by designing in plenty of margin in the 9210's components and specifications. Component and connector counts are low, cooling is generous-

ly provided, and automated testing routines are extensive.

#### ALL THIS AT A PRICE YOU CAN AFFORD -

Compare the cost of the Model 9210 with that of comparable instruments. Even with all its innovative features and high performance, the Model 9210 is competitively priced.

## Functional Description

The LeCroy Series 9210 Pulse Generator is a high performance programmable pulse generator which uses a flexible modular architecture. The system can be performance matched to a wide range of pulse generator applications by the selection of the appropriate plug-in output modules. The modular architecture allows the pulse generator to be re-configured to match changing needs at minimum cost. The following three output modules are available, offering picosecond edges, high output swings, and wide rise time variability.

**Model 9211** - 250 MHz Variable Edge Output Module

**Model 9213** - 50 MHz Variable Edge Output Module

**Model 9214** - 300 MHz 300 psec Edge Output Module

Plug-ins can be used in any combination and changed easily at any time. Pulse parameters for each output module, including delay, width, and transition

times, are independently adjustable. The modules share a common timebase and trigger mode.

The timebase in the 9210 mainframe offers six operating modes including: normal (free run) mode; four triggered modes including single, burst, gated, and external width; and double pulse mode.

The unit can be triggered by an external signal, front panel manual push-button, or via GPIB. External trigger threshold is user-programmable either manually or with an automatic trigger level adjustment. In externally triggered modes the external trigger frequency is measured by an internal frequency counter and displayed on the CRT.

An output trigger pulse, with programmable or preset TTL or ECL compatible levels, is available for synchronization.

The 9210 Series sets a new standard for accuracy and precision. It achieves 5 mV amplitude resolution with 1% DC accuracy. Its time resolution is 10 psec with a timebase accuracy of  $\pm(0.5\% + 200 \text{ psec})$ . Internal self-calibration using a built-in frequency counter and 12-bit analog-to-digital converter are combined with other accuracy related features, such as load compensation, to obtain these high levels of accuracy.



The front panel operation of the 9210 has been designed for intuitive error free setup. The friendly user interface is centered on a bright CRT display which shows all related setup parameters at a glance. The menu based display adapts automatically to match the installed output modules. A graphical icon is included to show the parameter being adjusted. Settings conflicts are highlighted and help messages appear on screen. Settings are changed by means of either a numeric keypad for precise numeric entry or by means of an analog knob for continuous variation of parameters.

CRT touch-screen response allows the user to set and change parameters through the use of optical soft keys.

For added operational convenience, alternate settings formats can be selected. These include: duty cycle or pulse width, frequency or period, delay or phase, amplitude/median and amplitude/offset or Vhigh/Vlow, slew rate or rise time – all key selectable.

Fully programmable via GPIB, the 9210 pulse generator complies with the IEEE-488.2 interface standard. It uses a self-documenting, English-language based command set and features high-speed command execution.

**Important Note:** At least one output module (9211, 9213, or 9214) must be installed in the 9210 Pulse Generator Mainframe in order to obtain a pulse output.

## TIMING CHARACTERISTICS

Defined at 50% amplitude points and minimum transition times.

*NOTE: The minimum values listed below refer to the mainframe only, and may not be achievable with all output modules.*

**Pulse period:** 3.33 nsec to 450 msec.

**Resolution:** The greater of 0.1% of value or 10 psec.

**Accuracy:**  $\pm(0.5\%$  of value + 0.2 nsec) from 3.33 nsec to 450 msec.

**RMS jitter:**  $\leq 0.035\%$  (350 ppm) of value + 35 psec.

**Temperature coefficient:** < 250 ppm/°C typical with temperature compensation ON.

**Frequency:** Alternate format for period. Settable from 300 MHz to 2.2 Hz with 0.1% resolution.

**Pulse width:** 1.0 nsec to 450 msec. For period setting  $\leq 8.0$  nsec; max. width = period -0.8 nsec.

For period setting > 8.0 nsec; max. width = period -2.9 nsec.

**Resolution:** The greater of 0.1% of value or 10 psec.

**Accuracy:**  $\pm(0.5\%$  of value + 0.3 nsec transition time error) from 1.6 nsec to 450 msec (see output module data for transition time accuracy specifications).

**RMS jitter:**  $\leq 0.035\%$  of value + 35 psec.

**Temperature coefficient:** < 250 ppm/°C typical with temperature compensation ON.

**Duty cycle:** Alternate format for width. Settable from 1% to 99% in 0.01% steps. In this format, width is controlled as a percentage of period.

**Pulse delay:** 0 nsec to 450 msec, measured from leading edge of trigger out to *beginning* of leading edge of pulse output (relative to fixed offset).

For period setting  $\leq 8.0$  nsec; max. delay = period -2.6 nsec.

For period setting > 8.0 nsec; max. delay = period -4.7 nsec.

**Resolution:** The greater of 0.1% of value or 10 psec.

**Accuracy:**  $\pm(0.5\%$  of value + 1.0 nsec).

**RMS jitter:**  $\leq 0.035\%$  of value + 35 psec.

**Temperature coefficient:** < (250 ppm + 50 psec)/°C typical with temperature compensation ON.

**Match between output modules of the same type:** 1.2 nsec.

**Phase:** Alternate format for delay. Settable from 0° to 359.9° with 0.1° resolution. In this format, delay = phase/360 x period.

**Double pulse delay:** 4 nsec to 450 msec.

**Resolution:** The greater of 0.1% of value or 10 psec.

**Accuracy:**  $\pm(0.5\%$  of value + 0.3 nsec).

**RMS jitter:**  $\leq 0.035\%$  of value + 35 psec.

**Temperature coefficient:** < 250 ppm/°C typical with temperature compensation ON.

## INPUTS AND OUTPUTS

### External Input

**Input impedance:** 10 kW or 50 W  $\pm 5\%$ , selectable.

**Input range:**  $\pm 5$  V into 50 W or  $\pm 20$  V into 10 kW.

**Minimum detectable amplitude:** 200 mV.

**Threshold range and resolution:**  $\pm 2.5$  V adjustable in 20 mV steps.

**Threshold level accuracy:**  $\pm 100$  mV.

**Max. input frequency:** 300 MHz.

**Min. pulse width:** 1.5 nsec.

**Min. input slew rate:** 10 V/sec.

**Edge selection:** Positive, negative, neither edge (disabled).

### Trigger Output

**Output levels:** Nominal 1 V negative swing from base level into 50 W. Base level adjustable over  $\pm 1.5$  V range with 20 mV resolution. (Into Hi-Z: amplitude = -2 V. Base level of  $\pm 3$  V, 40 mV resolution.)

**Output impedance:** 50 W  $\pm 5\%$ .

**Protection:** Protected against application of  $\pm 10$  V.

**Delay from trigger input:** 21 nsec typical.

**Width:** Dependent on trigger mode.

#### Normal mode:

Period  $\leq 7.2$  nsec:

Width = 1.8 nsec typical.

7.2 nsec < period <

50 nsec:

3.6 nsec  $\leq$  width  $\leq$

7.2 nsec:

Period  $\geq 50$  nsec:

Width = 25 nsec typical.

#### Single mode:

Pulse width setting  $\leq 40$  nsec:

Trigger output width =

1.8 nsec typical.

Pulse width setting > 40 nsec:

Trigger output width =

25 nsec typical.

#### Burst mode:

Width = period x (burst count - 1).

#### Gate and ext. width modes:

Trigger output width = trigger input width.

## PROGRAMMABILITY

All generator functions are programmable over GPIB. Command set conforms with IEEE 488.2-1987.

## TRIGGERING MODES

**Normal:** Continuous pulse stream.

Trigger output for each pulse output.

**Single:** Each external trigger input generates a single output pulse. One trigger output for each trigger.

**Gated:** Signal at external input enables period generator. The first output pulse is synchronized with the gate's leading edge. Last pulse is allowed to complete. One trigger output for each gate input; 20 nsec retrigger (dead) time between gate inputs.

**Burst:** Each external trigger input generates a pre-programmed number of pulses (3 to 4095). Minimum time between two bursts is 50 nsec. One trigger output for each trigger.

**External width:** The signal at the external input is reproduced with programmable transition times and output levels. Trigger output for each external trigger.

**OPERATING FEATURES**

**Manual trigger:** Front panel push-button generates an external trigger input. Each push provides one trigger pulse in single and burst modes. Output remains active as long as button is pressed in gate and external width modes.

**Double pulse mode:** When double pulse is set to ON, two pulses are produced for each trigger. The first pulse begins as soon as possible after the trigger (approximately the minimum pulse delay time). The delay parameter now specifies the time from the leading edge of the first pulse to the leading edge of the second pulse. One trigger output occurs for each pulse pair. Compatible with all trigger modes except external width.

**ADDITIONAL CAPABILITIES**

**Limit:** When enabled, the maximum high and low level settability of the pulse outputs is limited to protect the device under test.

**Setups:** 16 setup configurations can be stored and recalled using the store and recall keys on the front panel.

**Change format:** Enables the alternate representation of a parameter or enables an alternate mode of operation. Examples are amplitude/base or amplitude/median in lieu of Vhigh/Vlow, duty cycle instead of width, phase instead of delay, frequency instead of period, slew rate as opposed to transition time.

**ENVIRONMENTAL**

The following specifications apply to the 9210 mainframe and to all output modules (9211, 9213 and 9214).

**Storage temperature:** -40°C to 70°C (temp above 40°C may degrade battery life).

**Operating temperature:** 5°C to 40°C at rated specifications, operational from 0°C to 50°C.

**Temperature & self-calibration:** Generator and output modules will meet specifications over a  $\pm 5^\circ\text{C}$  range without repeating self-calibration.

**Humidity range:** < 95% R.H from 5°C to 40°C.

**POWER**

115/220 VAC  $\pm 20\%$ ; 48 - 448 Hz, 300 Watts max. (180 typical).

**MISCELLANEOUS**

**Battery backup life:** 10 years typical.

The following specifications apply to the 9210 mainframe and to all output modules (9211, 9213 and 9214).

**Recalibration interval:** 1 year.

**Warm-up time (to meet specs):** 15 min, after which a new self-calibration must be performed.

**MAINFRAME**

**Weight:** 23 lbs. net, 34 lbs. shipping.

**Dimensions:** (HWD) 5 x 17 x 21 inches.

**OUTPUT MODULES**

**Weight:** 2 lbs. net, 4 lbs. shipping.

**Dimensions:** (HWD) 4.6 x 2.4 x 14.7 inches.



## 9211 - 250 MHz Output Module Specifications

### TIMING CHARACTERISTICS

**Maximum rep rate:**  $\geq 250$  MHz.

**Minimum pulse width:**  $\leq 2.0$  nsec.

**Fixed delay from trigger out:** 13 nsec  $\pm 4$  nsec.

### OUTPUT CHARACTERISTICS

Specified with both outputs terminated in 50.00 W. (Ratings in { } are when driving an open circuit.)

**Outputs:** Normal and complementary polarity.

**Short circuit output current:**  $\pm 260$  mA.

**DC output source impedance:** 50  $\pm 1.0$  W.

**Output protection:** Protected against application of  $\leq \pm 15$  V.

### OUTPUT LEVELS

**High level:** -4.95 V to +5.00 V { -9.90 V to +10.00 V }

**Low level:** -5.00 V to +4.95 V { -10.00 V to +9.90 V }

**Output voltage range:**  $\pm 5$  Volts ( $\pm 10$  Volts); max. amplitude of 5 V {10 V}; min. amplitude of 50 mV {100 mV}.

**Resolution:** 5 mV {10 mV}.

### Level Accuracy

**Normal output:**  $\pm 1\%$  of programmed value +1% of amplitude +40 mV into 50.00 W.

**Accuracy with load comp:** The same accuracy as stated above will be maintained for user supplied load of 47 W to 1 MW when load compensation feature is enabled.

**Complementary output:**  $\pm 1\%$  of programmed value +3% of amplitude +40 mV into 50.00 W.

**Accuracy with load comp:**  $\pm 3\%$  of setting times the ratio of the load on the complemented output to the load on the normal output). Measurements for the load compensating correction factors are made on the normal output.

### PULSE PERFORMANCE

Variable transition times (10% to 90%):

**Leading edge:**  $\leq 1.2$  nsec min (1 nsec typical) to 10 msec.

**Trailing edge:**  $\leq 1.2$  nsec min (1 nsec typical) to 10 msec.

**Ranges:** 7 ranges of 25:1. Minimum lead to trail dynamic range = 2.5:1, except 2:1 at first range break (see graph below).

**Resolution:** The greater of 1% or 100 psec.

**Accuracy:**  $\pm (10\%$  of value + 300 psec).

**Linearity:**  $\pm 3\%$  typical (10 - 90%) for transition times  $> 50$  nsec.

**Slew rate mode:** Settable down to 0.1 V/msec with 0.1% resolution and  $\pm 10\%$  accuracy (separately settable for leading and trailing edge). Max. rate determined by amplitude setting & transition time limits stated above.

**Overshoot and ringing:** The greater of  $\pm 8\%$  of amplitude or  $\pm 10$  mV.

**Settling time:**  $\leq 10$  nsec to 2% of amplitude change at fastest transition times.

**Normal to complementary output**

**skew:** 200 psec max at fastest transition times (50 psec typical).

### MODULE CONTROLS

The following controls are located on the front panel of the output module.

**Invert:** Inverts normal output pulse levels. Quiescent and active levels exchanged.

**Disable:** Output circuitry is disconnected via relay.

**Display channel:** Instructs mainframe to select and display the settings parameters for this module.

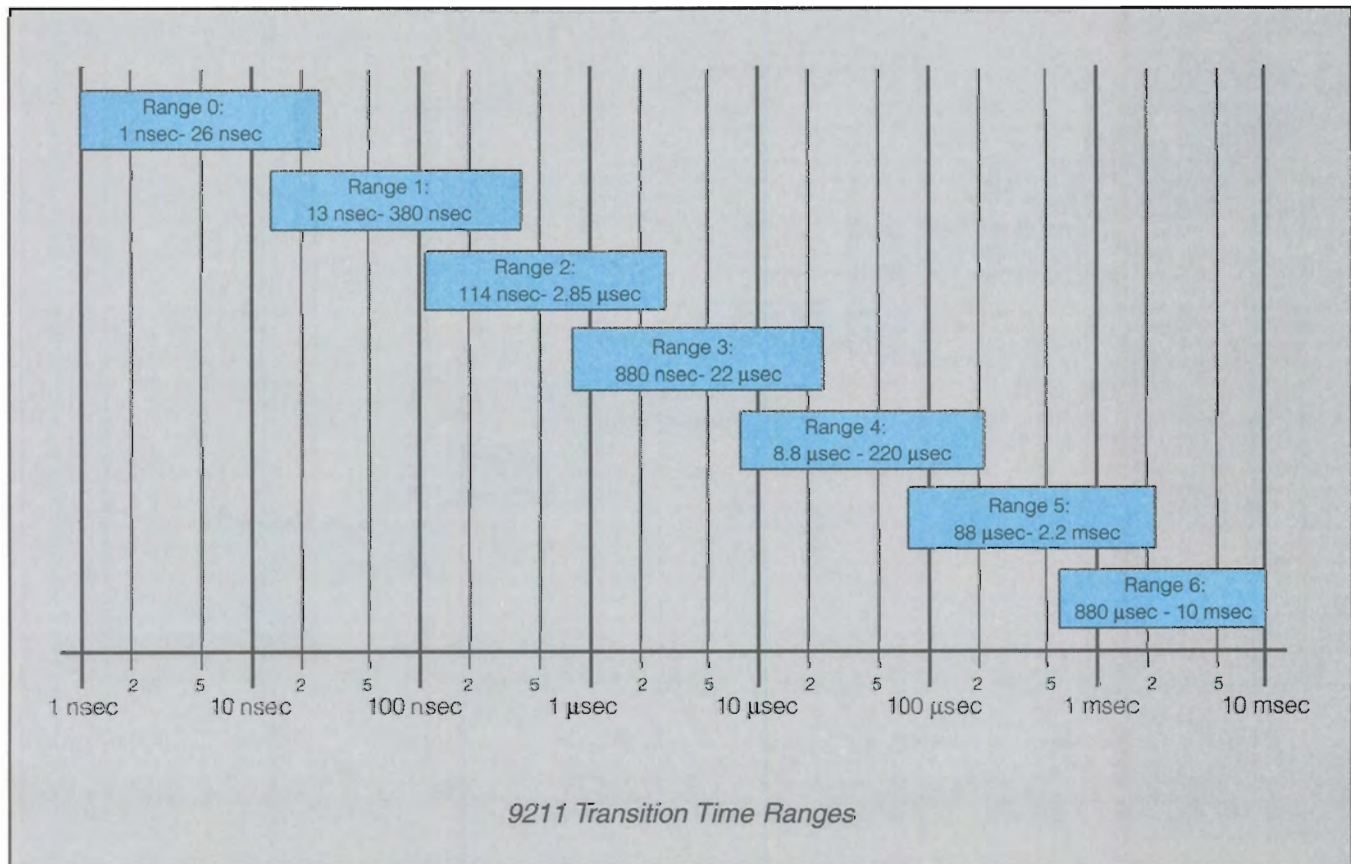

## 9213 - 50 MHz, 16 V Output Module Specifications

### TIMING CHARACTERISTICS

**Maximum rep rate:**  $\geq 50$  MHz.

**Minimum pulse width:**  $\leq 10.0$  nsec.

**Fixed delay from trigger out:** 13 nsec  $\pm 4$  nsec.

### OUTPUT CHARACTERISTICS

Specified with output terminated in 50.00 W. (Ratings in { } are when driving an open circuit.)

**Output:** Normal polarity.

**Short circuit output current:**  $\pm 200$  mA.

**DC output source impedance:**

50  $\pm 2.0$  W.

**Output protection:** Protected against application of  $\leq \pm 40$  V.

### OUTPUT LEVELS

**High level:** -7.98 V to +8.00 V  
{-15.96 V to +16.00 V}

**Low level:** -8.00 V to +7.98 V  
{-16.00 V to +15.96 V}

**Output voltage range:**  $\pm 8$  Volts { $\pm 16$  Volts}; max. amplitude of 16 V {32 V}; min. amplitude of 20 mV {40 mV}.

**Resolution:** 5 mV {10 mV}.

**Level accuracy:**  $\pm(1\%$  of programmed value  $+1\%$  of amplitude  $+40$  mV) into 50.00 W.

**Accuracy with load comp:** The same accuracy as stated above will be maintained for user supplied load of 47 W to 1 MW when load compensation feature is enabled.

### PULSE PERFORMANCE

**Variable transition times (10% to 90%):**

**Leading edge:**  $\leq 6.5$  nsec to 95 msec.

**Trailing edge:**  $\leq 6.5$  nsec to 95 msec.

**Ranges:** 8 ranges of 25:1. Minimum lead to trail dynamic range = 2.5:1 (except for lowest range, see graph below).

**Resolution:** The greater of 1% or 100 psec.

**Accuracy:**  $\pm(10\%$  of value  $+ 300$  psec).

**Linearity:**  $\pm 3\%$  typical (10-90%) for transition times  $> 100$  nsec.

**Slew rate mode:** Settable down to 0.1 V/msec with 0.1% resolution and  $\pm 10\%$  accuracy (separately settable for leading and trailing edge). Max. rate determined by amplitude setting and transition time limits stated above.

**Overshoot and ringing:** The greater of  $\pm 8\%$  of amplitude or  $\pm 10$  mV.

**Settling time:**  $< 50$  nsec to 2% of amplitude change for amplitudes  $\leq 10$  V or to 3% of amplitude change for amplitudes  $> 10$  V (at fastest transition times).

### MODULE CONTROLS

The following controls are located on the front panel of the output module.

**Invert:** Inverts normal output pulse levels. Quiescent and active levels exchanged.

**Disable:** Output circuitry is disconnected via relay.

**Display channel:** Instructs mainframe to select and display the settings parameters for this module.

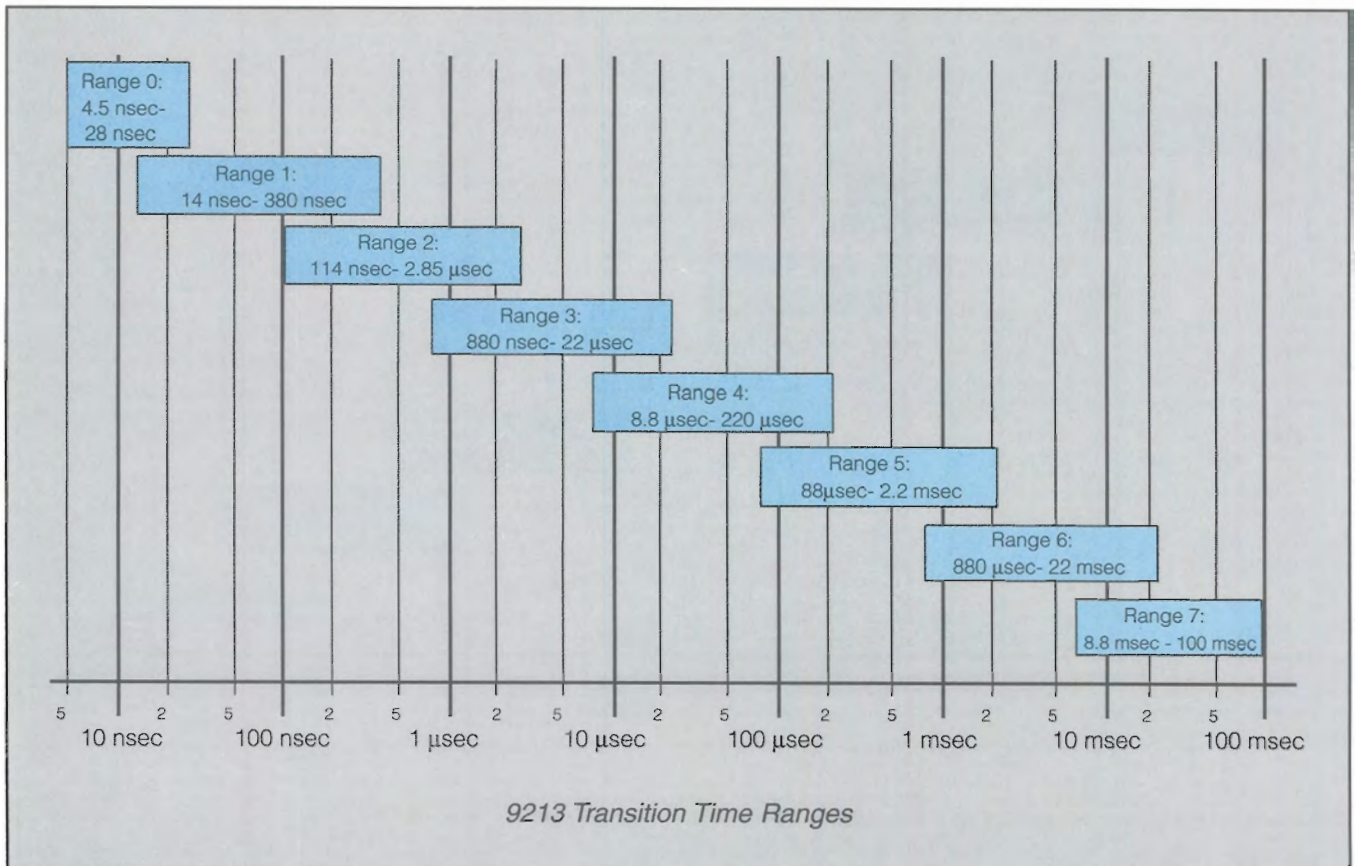



## 9214 - 300 MHz, 300 psec Output Module Specifications

### TIMING CHARACTERISTICS

**Maximum rep rate:**  $\geq 300$  MHz.  
**Minimum pulse width:**  $\leq 1.2$  nsec.  
**Maximum pulse width:**  
 For period setting  $\leq 8.0$  nsec;  
 max. width = period -1.4 nsec.  
 For period setting  $> 8.0$  nsec;  
 max. width = period -3.5 nsec.  
 Fixed delay from trigger out: 13 nsec  
 $\pm 4$  nsec.

### OUTPUT CHARACTERISTICS

Specified with both outputs terminated in 50.00 W. (Ratings in { } are when driving an open circuit.)  
**Outputs:** Normal and complementary polarity.  
**Short circuit output current:**  
 $\pm 240$  mA.  
**DC output source impedance:**  
 $50 \pm 1.0$  W.  
**Output protection:** Protected against application of  $\leq \pm 6$  V.

### OUTPUT LEVELS

**High level:** -4.50 V to +5.00 V  
 {-4.00 V to +5.00 V}  
**Low level:** -5.00 V to +4.50 V  
 {-5.00 V to +4.00 V}  
**Output voltage range:**  $\pm 5$  Volts { $\pm 5$  Volts} (amplitude will double into a high impedance up to the 5 V level limit). Max. amplitude of 5 V {10 V}. Min. amplitude of 500 mV {1 V}.  
**Resolution:** 5 mV {10 mV}.  
 Level Accuracy  
**Normal output:**  $\pm 1\%$  of programmed value +1% of amplitude +40 mV into 50.00 W.  
**Accuracy with load comp:** The same accuracy as stated above will be maintained for user supplied load of 47 W to 1 MW when load compensation feature is enabled.  
**Complementary output:**  $\pm 1\%$  of programmed value +3% of amplitude +40 mV into 50.00 W.  
**Accuracy with load comp:**  $\pm 3\%$  of setting times the ratio of the load on the complemented output to the load on the normal output). Measurements

for the load compensating correction factors are made on the normal output.

### PULSE PERFORMANCE

**Minimum transition time:**  $\leq 300$  psec guaranteed (20% - 80%).  
**Overshoot and ringing:** The greater of  $\pm 10\%$  of amplitude or  $\pm 10$  mV.  
**Settling time:**  $\leq 10$  nsec to 2% of amplitude change.  
**Normal to complemented output skew:** 100 psec max. (25 psec typical).

### MODULE CONTROLS

These controls are located on the front panel of the output module.  
**Invert:** Inverts normal output pulse levels. Quiescent and active levels exchanged.  
**Disable:** Output circuitry is disconnected via relay.  
**Display channel:** Instructs mainframe to select and display the settings parameters for this module.



Models 9211, 9213 and 9214 plug-ins



The 9210 makes it easy to monitor the pulse generator setup. It also changes format to match the way you specify pulses. You can ask for "duty cycle" instead "width" and "frequency" or specify the leading edge risetime in "slew rate" instead of "nanoseconds".



## 9200 & LW400 Series

### Signal Sources

		US \$
9210	300 MHz Modular Pulse Generator Accommodates 2 output modules	7,875
9211	250 MHz Output Module With complementary outputs and variable transition times	2,365
9213	50 MHz Output Module With variable transition times	1,575
9214	300 MHz Output Module with complementary outputs	3,045
LW410	Single Channel 400 MS/s Arbitrary Waveform Generator	13,945
LW420	Dual Channel 400MS/s Arbitrary Waveform Generator	18,950

### Signal Source Options & Accessories

9210-OM	9210 Operator's Manual Included with 9210	85
9210-2-50/M1	9210 W/2 9213 plus MOD1 x10 better delay resolution	11,025
9210/RM	9210 Rack Mount Assembly For 9210 Mainframe	290
9210/SC	Soft Carrying Case for 9210	310
9210-SM	9210 Service Manual Covers all 92XX modules	125
LS-RM	Rackmount Adapter for LW410/420	340
LS-SOFT	Soft Carrying Case for LW410/420	199
LS-TRANS	Transit Case For LW410/420	570
LW410-ME2	1 Megasample memory 1 Channel	3,495
LW420-ME2	1 Megasample memory 2 Channels	4,995
LW400-HD1	>400 Mbyte Hard Disk Drive	1,195
LW400-OM	Operators Manual for LW410/420 Included with LW410/420	85
LW400-RPG	Remote Programming Manual for LW410/420 Included with LW410/420	85
LW400-SM	Service Manual for LW410/420	125
LW400-09	Digital Output Channel 1 Only	1,995
OC9003	Oscilloscope Cart with Drawer and Printer Shelf	795

# 1-800-5-LECROY

Signal Source Ordering Information

# Ordering Information

## 9200 & LW400 Series

### Warranties & Calibration

		US \$
91XX-EW	1 Year Extended Warranty on any 9100 Series Signal Source	520
91XX-CC	NIST Calibration Certificate on any 9100 Series Signal Source	350
91XX-MIL	MILSTD 45662A Calibration on any 9100 Series Signal Source	450
91XX-CM5	5 MILSTD Calibrations on any 91XX Series Signal Source	1400
91XX-C5	5 NIST Calibrations on any 91XX Series Signal Source	1,000
91XX-T5	5 Year Warranty and 5 NIST Cals on any 9100 Series Signal Source at time of purchase only	1,970
91XX-W5	5 Year Extended Warranty on any 9100 Series Signal Source at time of purchase only	1,190
9210-CC	NIST Calibration Certificate on 9210 Mainframe	250
9210-MIL	MILSTD 45662A Calibration on 9210 Mainframe	350
92XX-CC	NIST Calibration Certificate on any 9200 Series Plug-in	150
92XX-MIL	MILSTD 45662A Calibration on any 9200 Series Plug-in	250
LW400-EW	1 Year Extended Warranty on any LW400 Series Signal Source	350
LW400-T5	5 Year Warranty and 5 NIST Cals on any LW400 Series Signal Source at time of purchase only	950
LW400-W5	5 Year Extended Warranty on any LW400 Series Signal Source at time of purchase only	500
LW400-C5	5 NIST Calibrations on any LW400 Series Signal Source	600
LW400-CM5	5 MILSTD 45662A Calibrations on any LW400 Series Signal Source	1000
LW400-CC	NIST Calibration Certificate on any LW400 Series Signal Source	350
LW400-MIL	MILSTD 45662A Calibration on any LW400 Series Signal Source	450

Signal Source Ordering Information

# 1-800-5-LECROY

VISA AND MASTER CARD ACCEPTED



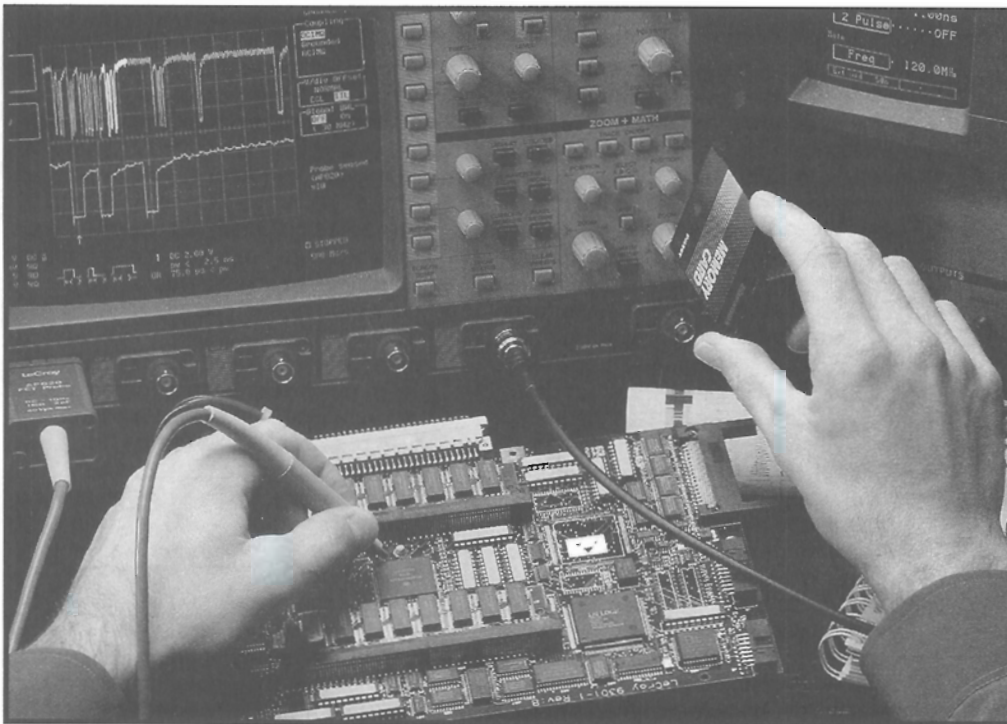

## Fundamentals of Digital Oscilloscopes and Waveform Digitizing

This technical note discusses how electronic signals are measured by data acquisition instruments and stored as numbers in fast memory. Concepts discussed include data sampling, triggering, recording, pre-trigger data, how sampling rate affects usable bandwidth and how long memory improves sampling rate. There is also a brief discussion of analysis possibilities including standard parameters, frequency analysis (FFT) and statistical analysis (histograms).

### Introduction

Digital oscilloscopes and waveform digitizers sample signals using a fast analog-to-digital converter (ADC). At evenly spaced intervals, the ADC measures the voltage level and stores the digitized value in high-speed dedicated memory. The shorter the intervals, the faster the digitizing rate, and the higher the signal frequency which can be recorded. The greater the resolution of the ADC, the better the sensitivity to small voltage changes. The more memory, the longer the recording time.

What are the benefits of this digital technology? Multiple signals associated with intermittent and infrequent events can be captured and analyzed instantly. Complex problems can be quickly identified by viewing waveform data which precedes a failure condition (pretrigger data). Captured waveforms can be expanded to reveal minute details such as fast glitches, overshoot on pulses, and noise. These captured waveforms can be analyzed in either the time or frequency domains.

#### MOST DIGITAL OSCILLOSCOPES PROVIDE:

- Capture of transient events
- Internally adjustable pretrigger viewing
- Superior measurement accuracy

- Fast measurements with cursors and automatic parametric readouts
- Quick hardcopies on printers and plotters
- Archives for later comparison or analysis
- Waveform mathematics and spectral analysis
- Complete programmability and automatic setups

#### GETTING TO AN INSTRUMENT SOLUTION

The instrument purchaser needs to understand basic digitizer specifications and architectures to get the right digitizer for the application. For analog oscilloscopes, the primary specifications are simply bandwidth, voltage sensitivity, and accuracy. For digital oscilloscopes, the basic specifications also include sample rate, vertical resolution, and waveform memory length. Some digitizer architectures are optimized for transient signal capture, while others only record repetitive signals.

#### KNOW YOUR WAVEFORM

Before you evaluate digitizers, evaluate your signals. Answering these questions regarding your signal and the types of measurements needed will help you choose the right instrument. This preparation will save time and money in the long run.



1. Are the signals ever transient in nature (intermittent, single-shot, random, modulating, drifting quickly, or occurring slower than 100 times per second)?
2. What is the signal bandwidth?
3. How small are the details you need to resolve relative to the peak-to-peak voltage?
4. How accurately do you want to measure voltages and times on the waveforms?
5. How long a waveform portion do you want to capture?
6. What conditions do you need to trigger on?
7. How often should the display update with new waveforms and analyzed results?
8. What kinds of analysis do you want?
9. How often will you change set ups?
10. Do you want to automate tests?
11. Do you want to store and recall waveforms?

#### TRANSIENT CAPTURE

Most analog scopes have a difficult time displaying transient events. In contrast, many digital oscilloscopes are designed for transient capture. Three basic digitizer architectures exist. Transient digitizers and Random Interleaved Sampling (RIS) digitizers can capture transient signals; sampling digitizers cannot. All three types can record repetitive signals. Only transient and RIS digitizers record pre-trigger waveform information; sampling digitizers cannot.

Transient digitizers contain an analog-to-digital converter (ADC) and waveform memory. Once "armed", the ADC digitizes the signal continuously and feeds the samples into the memory using circular addressing. After the last memory location is filled, the system overwrites the stored data, starting at the beginning of memory. After a trigger is generated, memory continues to fill with a user-selected number of post-trigger samples. Then the ADC stops feeding the memory. If the user had selected 100% pre-trigger data, then the ADC would stop sending data as soon as the trigger arrived. If the user selected 100% post-trigger, then the system

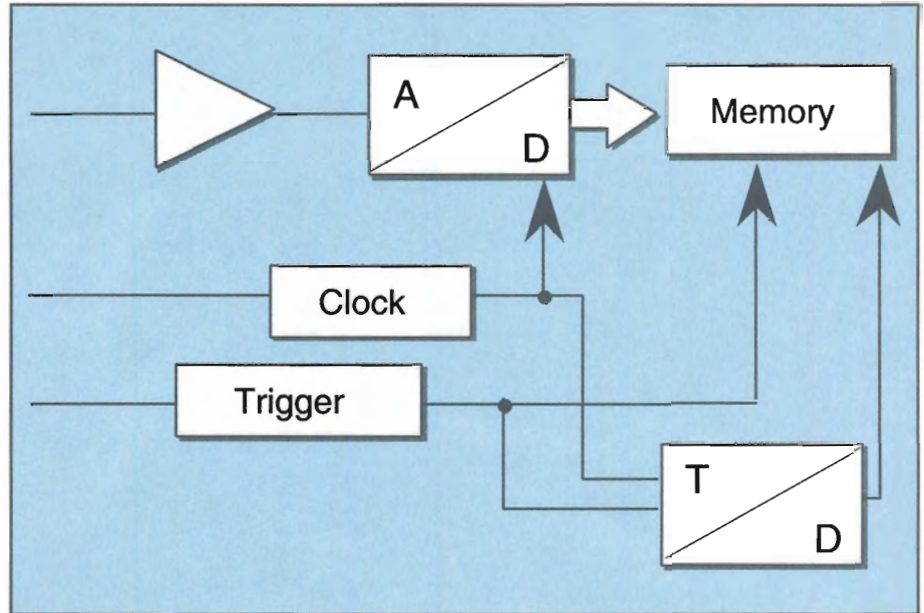

RIS digitizer block diagram

would fill every memory location one more time and stop. Memory would contain waveform data which occurred after the trigger.

RIS digitizers consist of a transient digitizer with the addition of an interleaved mode. For each trigger, the RIS digitizer records a set of waveform sample points. The digitizer interleaves sample point sets from additional triggered acquisitions to construct a detailed representation of the original wavelshape.

Since the digitizer has no way of knowing when the trigger will arrive, the sample clock and the trigger point are asynchronous. Therefore, the time between the trigger and the very next sample clock randomly varies from waveform acquisition to acquisition. The RIS architecture uses a time-to-digital converter (TDC) to measure this relationship and

accurately interleave successive waveform acquisitions. The TDC has much better timing resolution than the sample interval, so RIS reconstructions can reveal details that the transient digitizer alone misses. Yet the RIS digitizer provides user-selectable pretrigger recording, just like the transient digitizer.

Sampling digitizers effectively consist of a sampling head, an ADC, waveform memory, and some timing circuitry. The sampling head stores the voltage and then holds it while the ADC digitizes it. Sampling digitizers acquire just one sample per trigger. For each successive trigger, the timing circuitry delays the time from the trigger to the sample point. For example, for an equivalent sample rate of 1 GS/sec, the first sample point would be at the trigger point, the second delayed by 1 nsec, the third delayed by 2 nsec, and so on. Since the sample points are delayed from the

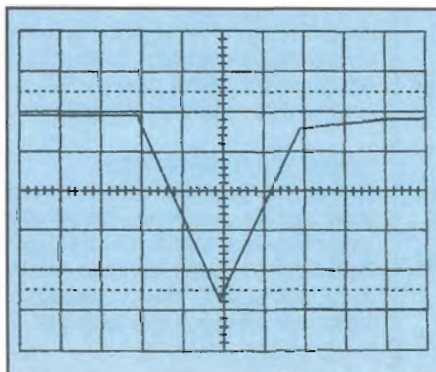

100 MS/sec digitizing of 5 nsec wide pulse

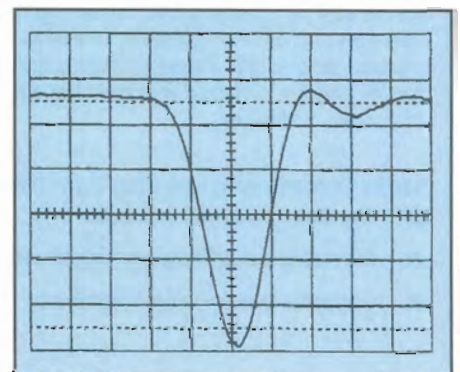

5 GS/sec RIS digitizing of 5 nsec wide pulse



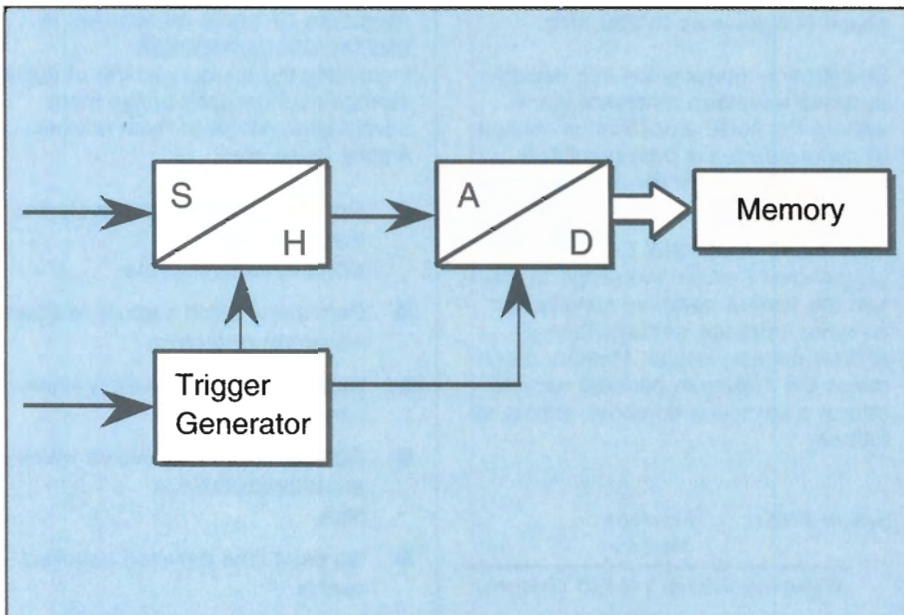

Sampling digitizer block diagram

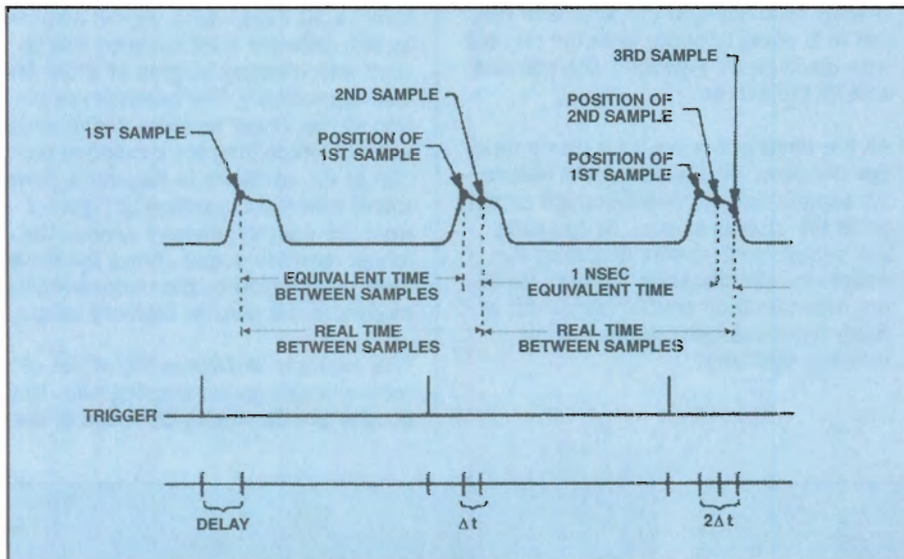

Sampling digitizer block diagram

trigger point, sampling digitizers cannot record pre-trigger information. With one sample per trigger, sampling digitizers can take a long time to construct long waveform records. For example, for a 1,000 point long record, they require 1,000 waveforms to occur, and for a 50,000 point record, 50,000 waveforms.

### BANDWIDTH AND SAMPLE RATE

Bandwidth is an important specification for digitizers, just like analog scopes. The digitizer's input amplifiers and its filters determine the bandwidth. Fast pulse edges and sharp waveform peaks contain high frequen-

cy signal components. To accurately record these edges and peaks, the digitizer must have adequate bandwidth to pass these high frequency signal components with minimal attenuation.

But how much bandwidth is enough? To accurately indicate signal peak amplitudes, the digitizer bandwidth should exceed the signal bandwidth. So first determine the signal bandwidth by estimating the fastest pulse rise time in your signal. Assuming a single pole system response, the signal bandwidth is as follows:

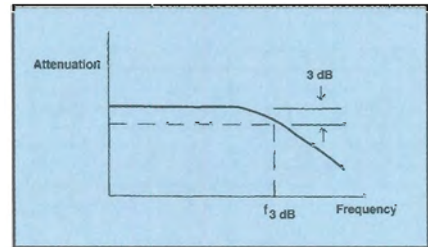

Attenuation occurs within the passband, not just at the cutoff (-3dB) frequency.

$$\text{Signal Bandwidth} \approx 0.35 / (10\% - 90\% \text{ rise time})$$

The digitizer bandwidth indicates the frequency at which the signal is attenuated by 3 dB (29%). This attenuation occurs gradually, starting at a much lower frequency. Therefore, choose a digitizer with higher bandwidth than the signal.

### SAMPLE RATE EFFECTS ON USABLE BANDWIDTH

The digitizer sample rate can degrade the usable bandwidth. To ensure adequate sampling, obtain 4 samples per cycle with  $\sin(x)/x$  interpolation, or 10 samples per cycle with straight line interpolation. If your signal is transient, then look at the single shot sample rate specification; if repetitive, then the faster equivalent time sample rate can be used.

Given an ideal the digitizer with no noise and given a bandwidth limited signal, Nyquist criterion holds true. Nyquist states that at least two samples must be taken for each cycle of the highest input frequency. In other words, the highest input frequency cannot exceed one half the sample rate. Given this scenario, a  $\sin(x)/x$  interpolation algorithm can reproduce the digitized input signal fairly accurately. The  $\sin(x)/x$  algorithm fits curve segments between sample points to create a smooth waveform representation. Unfortunately,  $\sin(x)/x$  interpolation can amplify noise. Since noise exists in real signals and digitizers,  $\sin(x)/x$  should be used cautiously,

Input Frequency (Relative to -3dB Frequency (F <sub>0</sub> ))	Attenuation	
	dB	%
1.0 F <sub>0</sub>	-3 dB	-29%
0.5 F <sub>0</sub>	-1 dB	-11%
0.1 F <sub>0</sub>	0.1 dB	-1%



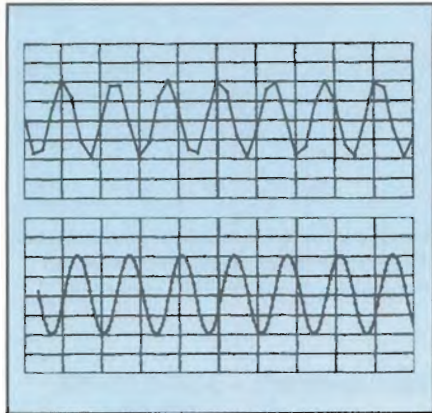

Sine wave digitized at 5 and 25 samples/cycle respectively, with straight line interpolation applied

especially with only 2 samples per cycle.

Sin(x)/x algorithms can also create undesirable overshoot and preshoot on fast edges. At least 2 data samples are required on the fastest edge in a signal. It is important that the user be able to examine the number of raw data points acquired in any scope using Sin(x)/x display.

For more accurate waveform representations, the digitizer should record at least four sample points per cycle of the highest frequency sine component. The additional sample points effectively enhance the signal-to-noise ratio for Sin(x)/x interpolation. For example, a 1 GS/sec (gigasample per second) sample rate could capture the wave-

shape of signals up to 250 MHz.

Straight line interpolation can deliver accurate waveform representations without the noise amplification caused by curve fitting. For best results, it requires 10 or more samples per cycle.

#### MAINTAINING USABLE BANDWIDTH

Long memory allows the scope to maintain the fastest specified sample rate on more timebase settings than a shorter memory scope. Memory determines the maximum possible sample rate at a particular timebase setting as follows:

$$\text{Sample Rate} = \frac{\text{Waveform Memory}}{(\text{Timebase Setting}) \times (\# \text{ CRT Divisions})}$$

For example, if the digitizer contained 50,000 points of memory and 10 CRT display divisions and the timebase is set to 5  $\mu\text{sec}/\text{division}$ , then the sample rate could be as high as 1 GS/sec and still fill the screen.

As the timebase is reduced (more time per division), the digitizer must reduce its sample rate to record enough signal to fill the display screen. By reducing the sample rate, it also degrades the usable bandwidth. Long memory digitizers maintain their usable bandwidth at more timebase settings than short memory digitizers.

#### BENEFITS OF LONG MEMORIES IN DIGITAL OSCILLOSCOPES

Increasing the memory length of digital storage oscilloscopes brings many advantages, not all of them obvious. Among these are:

- No missed details on waveforms, thanks to higher effective sampling rate.
- Permanent glitch capture, without waveform distortion.
- Better time and frequency resolution.
- Reliable capture of events which are unpredictable in time.
- No dead time between acquired events.

#### NO MISSED DETAILS

Figures 1 and 2 show the same waveform (a 50 msec video signal) acquired by two different oscilloscopes configured with memory lengths of 2.5M and 50k respectively. The superior resolution of the longer memory scope is best seen by comparing the expanded portion of its waveform in Figure# 1 (lower trace) with the expansion in Figure 2 from the shorter memory scope. The longer memory scope shows the waveform undistorted by the undersampling evident in the shorter memory scope.

This example illustrates the effect of record length upon sampling rate. Both scopes are displaying 50 msec of data

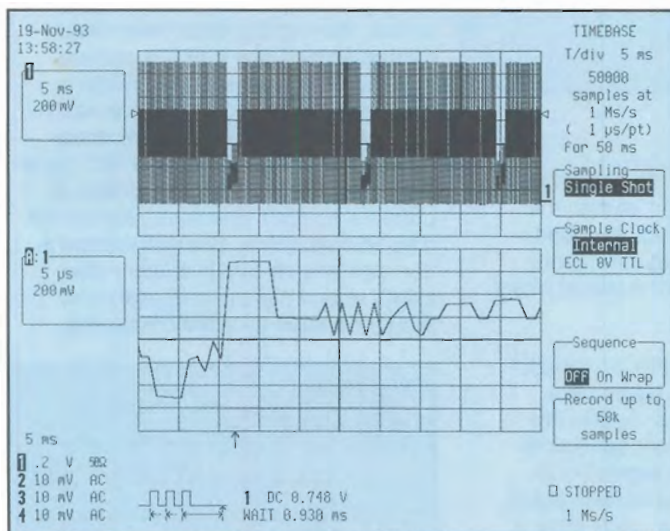

Figure 1: The 9354L always shows the maximum record length on screen, and sampling is always optimal. Note that the original trace and its expansion can be displayed simultaneously.

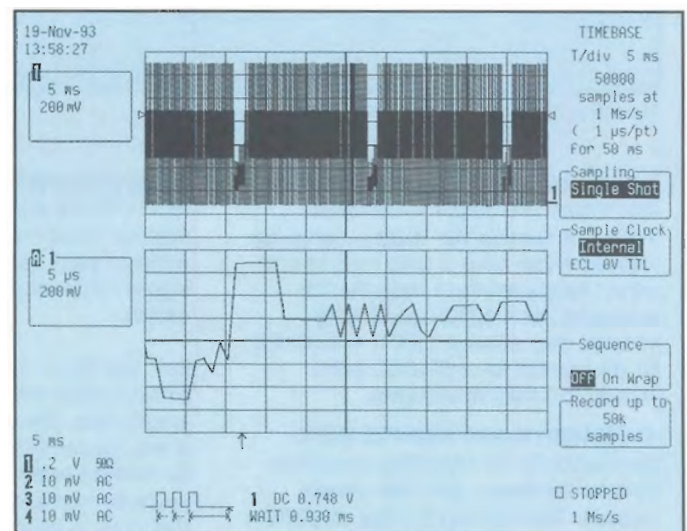

Figure 2: The same signal captured by a 50k memory scope. The trace is undersampled as shown in the expansion below the main trace.



(10 divisions at 5 msec/div). Thus the 50k point scope is digitizing at:

$$50 \text{ msec}/50,000 = 1 \text{ } \mu\text{sec per point} \\ = 1 \text{ MS/s}$$

while the 2,500,000 point scope is digitizing at:

$$50 \text{ msec}/2,500,000 = 20 \text{ nsec per point} \\ = 50 \text{ MS/sec}$$

Hence the sample rate is a direct function of memory length. (This is true up to the limit of the scope's maximum sample rate.) As a result, the scope with the longer memory will maintain its bandwidth over more time per division settings without compromising it with a much lower sampling rate. Even if two scopes have the same basic sampling rate capability for short waveforms, the DSO with the longer memory can "put more points on the waveform" and thereby give greater usable bandwidth for longer signals.

A word about default setups. In LeCroy oscilloscopes, the easiest to use default setup automatically digitizes the signal at a memory length and sampling rate optimized to yield the highest sampling rate possible for that time base setting. Scopes from other vendors may have a default setting that results in a 500 point digitization and 500 point display. Given the length of the waveform to be measured, an alternate setup will then have to be selected for it to capture and display the entire signal. The defaults represent a difference in philosophy, but the result is a difference

in convenience and often performance.

### PERMANENT GLITCH CAPTURE

Not all long memory scopes display data in the same way. Some display only a small portion of their long memory on screen, and window or scroll the display to show the rest of the data. LeCroy scopes represent all measured points on-screen in such a way that a live waveform can be displayed together with up to three expanded views. This is done using a proprietary compaction algorithm, and ensures that any glitch, representing as little as 1/8,000,000th of the displayed waveform, will always be captured accurately and displayed.

Compare this with scopes that rely on peak detection to capture glitches. While peak-detected data acquired may be useful to look at, it will no longer yield accurate parametric or cursor measurements, since all the time information has been randomly skewed.

Some DSO's have a special "Peak Detect" mode in which the ADC runs at its fastest sampling rate but only the maximum and minimum signal values are stored in memory. The time at which these peaks occur is not well known. An advantage of LeCroy's long memory is that half the memory can be used to store peak detected values while the other half can store a normally digitized picture of the signal.

### BETTER TIME AND FREQUENCY RESOLUTION

Comparing the different scopes in Figures 1 and 2, the first scope offers

50 times more horizontal points, and thus has better horizontal resolution by a factor of 50:1. Better horizontal resolution will improve the accuracy of any time-related measurement. It will also result in improved frequency domain (i.e., Fourier Transformed) displays, since the number of points displayed in an FFT is equal to the number of points in the original record (only half are displayed; the other half represent negative frequency).

### RELIABLE CAPTURE OF UNPREDICTABLE EVENTS

The occurrence of some events may be so unpredictable that they are difficult to trigger on reliably. The easiest way to acquire this type of event is with a long memory oscilloscope. The entire pulse train may be captured and expanded for examination. Once the nature of the failure is understood, LeCroy's SMART Trigger may be used to trigger on this particular type of event.

### NO DEAD TIME BETWEEN ACQUIRED EVENTS

There is a finite period of time after an acquisition has been made before any scope is ready to make another acquisition. During this period the scope performs various processing and display routines. This dead time, typically several milliseconds, creates problems when sequential events are being acquired. An example is the sequence of bursts shown in Figure 3. Displaying this accurately requires a high sampling rate over a relatively long period of time.

Figure 4 shows a similar signal, with longer "quiet time" between bursts.

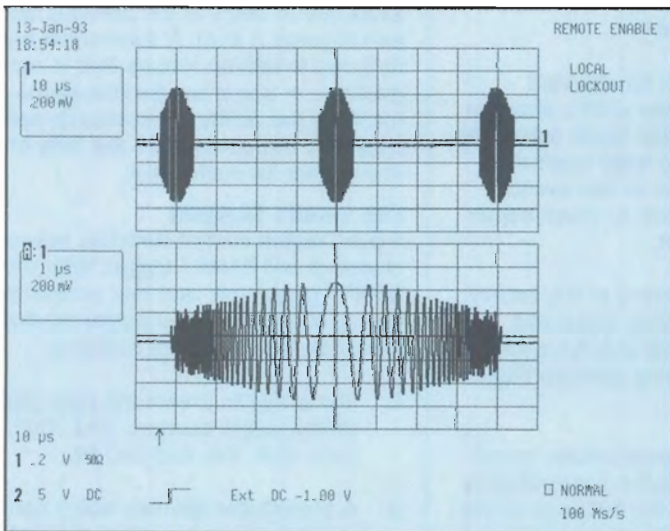

Figure 3

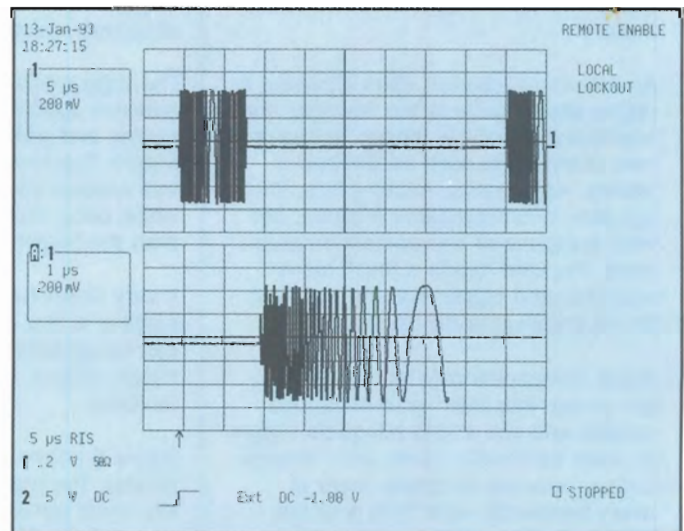

Figure 4

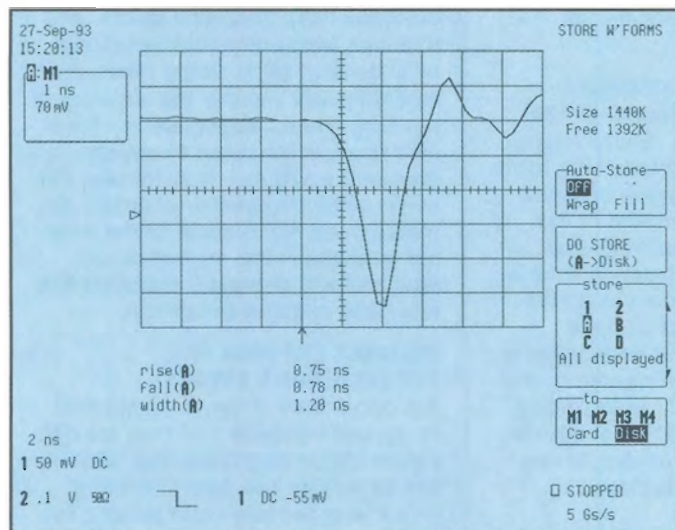

Figure 5: A typical 9354 display. Note the trigger level and source identified below the grid. The left-side and bottom arrows give a visual indicator of trigger level and time.

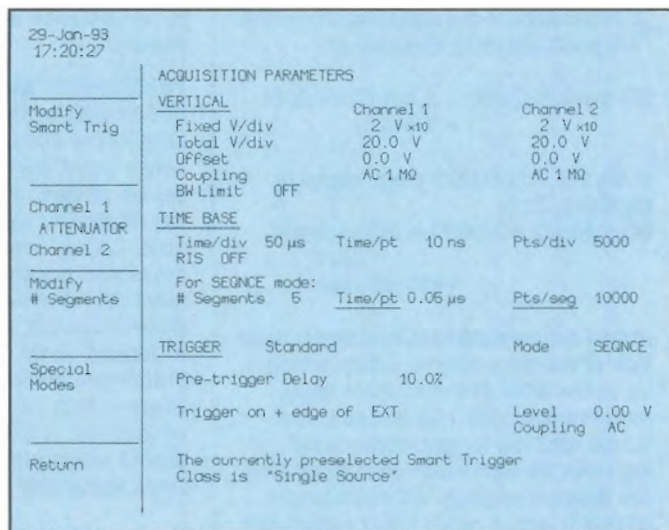

Figure 6: The acquisition parameter menu of the 9354 shows a summary of both the data acquisition and trigger conditions.

One way to acquire such bursts is to segment the scope's acquisition memory into many shorter memories. Using this technique will reduce the measurement dead time from milliseconds to less than 100 microseconds. Thus the bursts in our illustration could be stored into 50 separate, time-stamped memories of 1k each. The time stamp for each trigger is important since users often want to know the time when each event occurred. Scopes from some manufacturers will store multiple events without any time stamp information.

### TRIGGERING

The power of a digital oscilloscope in any given application depends on a combination of several features including the ability to trigger on the event of interest.

An important criterion when choosing a digital oscilloscope is the flexibility and sophistication of the trigger. To capture rare phenomena such as glitches or spikes, logic states, missing bits, timing jitter, microprocessor crashes, network hang-ups or bus contention problems, the user needs a much more sophisticated trigger system than that found in conventional oscilloscopes.

Some companies put their "good" trigger design into their more expensive scopes and use a less adequate trigger in lower bandwidth, lower price scopes. LeCroy believes all scope users at every bandwidth want both a simple standard trigger and the power of a

SMART Trigger to capture difficult events.

### THE STANDARD TRIGGER MODE

The standard mode resembles that of a conventional analog oscilloscope, and is directly controlled using the front-panel controls. The following controls and modes are available:

**Trigger source:** Channel 1, Channel 2, (Channel 3, Channel 4), Line, Ext, Ext/10.

**Trigger coupling:** AC, LF Reject, HF Reject, DC, HF.

**Trigger slope:** Positive, negative.

**Trigger level:** Channel 1, 2, 3 or 4. Ext: Adjustable to  $\pm 2$  V.

**Ext/10:** Adjustable to  $\pm 20$  V.

**Line:** Not adjustable.

**Trigger mode:** Single event, normal, automatic, sequence.

The trigger delay can be adjusted between 1,000 screen widths after the trigger, and one screen width before the trigger. Together with large memories, this enables the user to see events which occur much later or much earlier than the trigger itself.

A very distinctive feature of the LeCroy triggers is that coupling, slope and level can be adjusted separately for each trigger source, allowing ultimate trigger flexibility.

Figure 5 shows a typical LeCroy scope display. The trigger level is indicated by the small arrows at the left edge of the grid and the trigger timing position by

the arrow under the grid. At the bottom of the screen, a trigger summary, including LeCroy's trigger graphics, gives an overview of the trigger conditions. Figure 6 shows the data acquisition menu which is available at the touch of a button. The trigger conditions, as well as the acquisition conditions, are fully specified here.

Another important feature of the LeCroy triggers is Sequence Mode, which divides the long acquisition memories into as many as 4,000 segments. The instrument can then acquire as many events as the defined number of segments, and record each new event in successive segments.

Sequence Mode Acquisition is explained in detail in the previous section (Figures 3 & 4). A substantial benefit found in LeCroy scopes that is not available in some competitive instruments is the ability to timestamp each trigger so the user knows the time of occurrence for each event.

### THE SMART TRIGGER

A push-button control switches between standard and SMART trigger. With the SMART trigger the user has access to a variety of sophisticated trigger modes based on two important facilities.

1. The ability to preset the logic state of the trigger sources, Ch1, Ch2, Ch3, Ch4, Ext, and Ext/10.
2. A presettable counter, which can be used to count a number of events



between 1 and 109 or to measure time intervals from 2.5 nsec up to 20 sec in steps of 1% of the time scale.

Combining these two facilities opens the door to such a large variety of trigger conditions that the oscilloscope could potentially become cumbersome and difficult to use. However, great care has been taken to make the SMART trigger mode user-friendly without loss of versatility. On the screen, special trigger graphics illustrate the trigger conditions for every trigger mode. Examples of these graphics can be found below the grid in all the screen figures. The SMART trigger has several principal modes of operation:

- Single source trigger with hold-off
- Width triggers (+ glitch)
- Pattern trigger
- Dropout Trigger
- State-qualified trigger
- Edge-qualified trigger
- TV trigger

### SINGLE SOURCE TRIGGER - HOLD-OFF

Using this trigger mode, the user can select the desired source and its coupling, level and slope. A hold-off can be set when the waveform contains bursts or patterns and can be specified as a hold-off by time or number of events.

**Hold-off by time:** Many oscilloscope measurements require the ability to acquire a complex waveform which lacks any unique features to trigger on. Examples of these types of waveforms include data packets from local area networks, disk drive data streams, and outputs from charge coupled devices. These signals, which are clocked and generally of fixed length, are easily synchronized by using trigger hold-off by time or event.

Consider the Ethernet packet in Figure 7. Normal edge trigger cannot be used because there are many signal transitions that satisfy the trigger requirements. Since they occur at a much higher rate than the overall signal duration, the signal display is not stable. By using trigger hold-off, with a hold-off time equal to the signal duration, all intermediate triggers are ignored and the displayed trace is synchronized.

**Hold-off by events:** Consider the need to synchronize the acquisition of a pseudo random noise generator output. The data offers no distinctive trigger

points and the only available timing signal is the generator's clock signal. Knowing the length of the pseudo random sequence, 4095 states in the example shown in Figures 8 & 9, allows the use of hold-off by events. The clock signal, with a hold-off by 4094 events, is used as the trigger source.

Trigger hold-off is setup using the LeCroy SMART Trigger setup menu. In this application the single source trigger was used, as shown in Figure 8. The number of events is set to trigger on the 4095th clock synchronizing the acquisition with the pseudo random

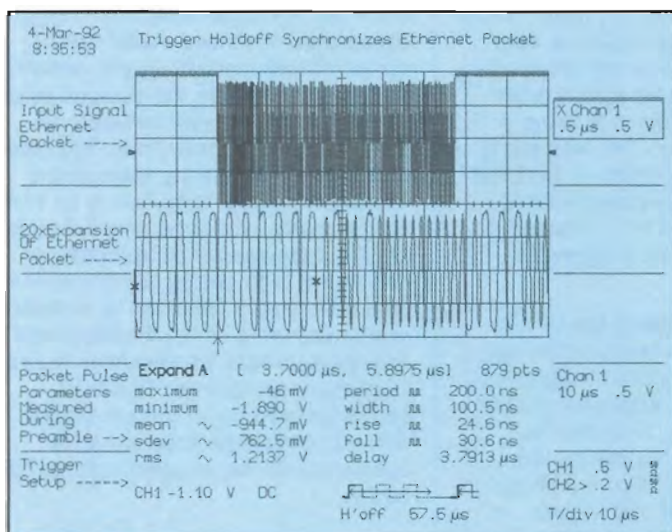

Figure 7: Trigger hold-off by time allows the above Ethernet signal to be displayed in its entirety as a stable trace despite repeated occurrences of valid trigger conditions. The 20:1 expansion in the lower trace and automatic pulse parameters characterize the packet's preamble.

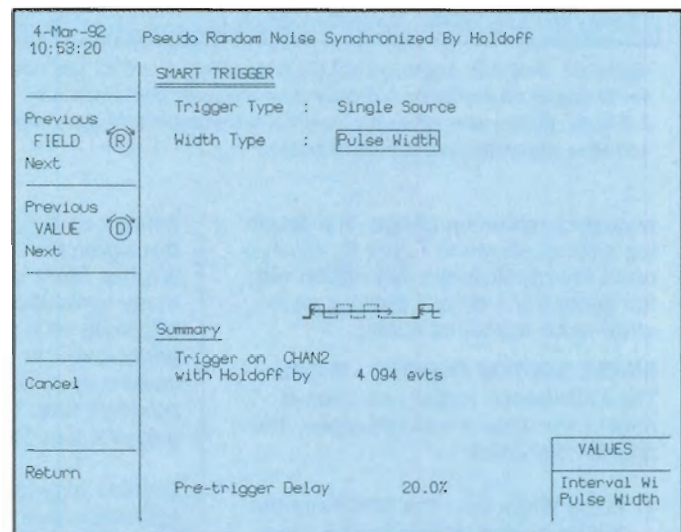

Figure 8.

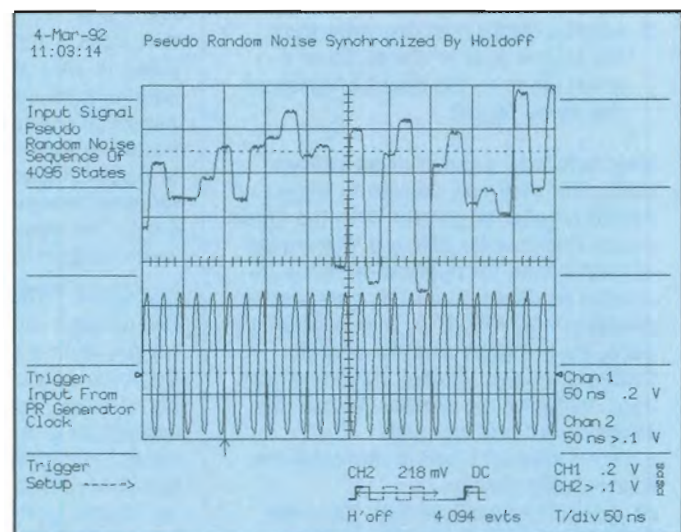

Figure 9.



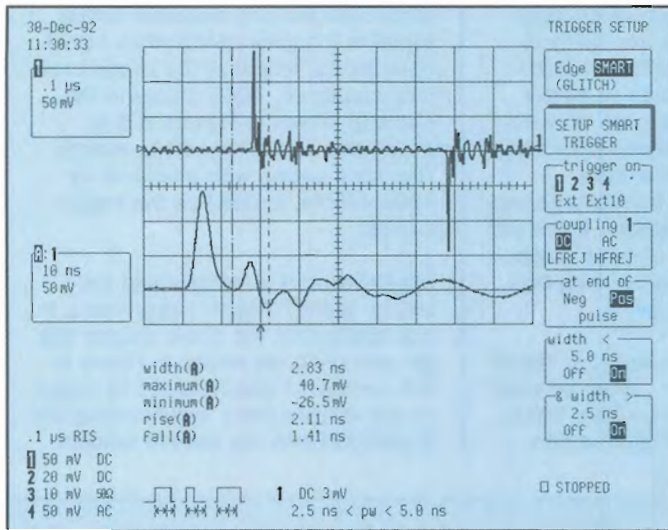

Figure 10: Selective trigger on a 2.83 nsec glitch. The DSO has been set to trigger on any pulse narrower than 5.0 nsec and wider than 2.5 nsec. Pulse parameters are used to characterize this phenomenon after expansion in the bottom trace.

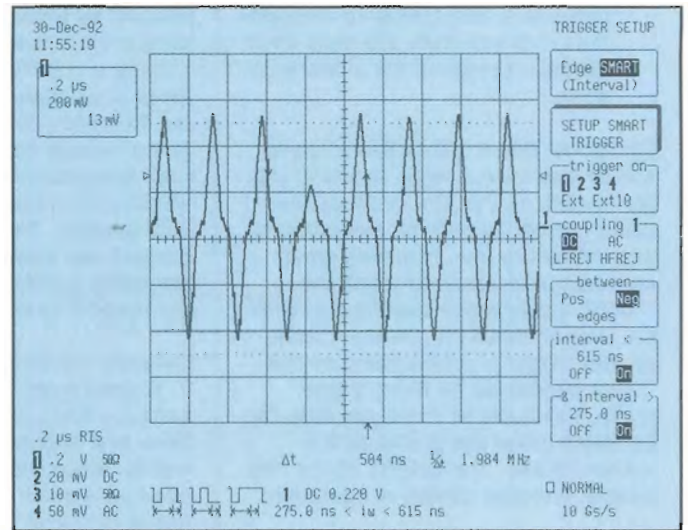

Figure 11: Triggering on a missing bit when reading a magnetic disk. A missing bit can be interpreted as a pulse wider than the period of the pulses, or a pulse separation greater than the pulse period. The "interval width >" is used to trigger on this condition.

sequence repetition period. The resulting display, shown in Figure 9, synchronizes the oscilloscope acquisition with the generator's output allowing each state to be examined easily.

#### SINGLE SOURCE TRIGGER - WIDTH

The width-based trigger has been a major innovation in oscilloscopes. Two possibilities exist:

1. Pulse Width (i.e., the time from the trigger source transition of a given slope to the next transition of opposite slope).
2. Interval Width (i.e., the time from the trigger source transition of a given slope to the next transition of the same slope).

After selecting a pulse or an interval width, the user can choose to trigger on widths smaller or greater than the given value. This feature offers a wide range of capabilities for application fields as diverse as digital and analog electronic development, ATE, EMI, telecommunications, and magnetic media studies. Catching elusive glitches becomes very easy. In digital electronics, where the circuit under test normally uses an internal clock, a glitch can be theoretically defined as any pulse narrower than the clock period (or half period). The oscilloscope can selectively trigger only on those events, as shown in Figure 10.

In a broader sense, a glitch can be

defined as a pulse much faster than the waveform under observation. As glitches are a source of problems in many applications, the possibility of triggering on a glitch, investigating what generated it, and measuring the damage caused by it, represents a fundamental research tool. The width-based trigger provides this capability.

Besides triggering on short widths (glitches) there is another substantial benefit of the "Width" trigger. In cases where jitter or other timing problems cause a pulse to be too wide, the user can trigger on long widths (trigger condition width > XX). Triggering on a wide pulse is also useful in many communications protocols where a wide pulse occurs at the beginning of a data-stream. In some cases, the user wants to trigger the scope based on the time elapsed between two rising or falling edges. An example of this "interval width" trigger is shown in figure 11.

#### DROPOUT TRIGGER

The dropout trigger allows the user to trigger when a signal stops occurring. Common applications are microprocessor crashes, network hangups and bus contention problems. The user connects the signals of interest to the oscilloscope and specifies a time period for one of them. If that signal becomes quiescent the scope triggers and data is displayed from all input channels. An example of dropout trigger used in power supply testing is shown on Page 175.

#### MULTI-SOURCE TRIGGERS - PATTERN

The pattern trigger is based on the logic state of the several input channels, CH1, CH2 (CH3, CH4) and EXT. Here the user can set the coupling and trigger level of each channel. He then chooses the required logic state for each input and decides whether the scope should trigger at the beginning of the defined pattern or at the end, i.e., when the pattern is "entered" or "exited". This type of trigger is present in 7200, 9400 and some 9300 series DSOs.

The width and time-separation trigger capabilities described above can be combined with pattern trigger, enabling the user to compare the duration of the pattern, or the interval between patterns, with a reference time. This type of trigger will be greatly appreciated whenever complex logic has to be tested. Examples are: setup and hold times on IC's, computer or microprocessor debugging; high energy physics where a physical event is identified by several events occurring simultaneously; and debugging of data transmission buses in telecommunications. Figure 12 shows an example of pattern trigger with no constraints apart from the occurrence of the required logic combination.

The pattern trigger is the logic AND of two to five defined input logic states. However, applying de Morgan's laws, the pattern trigger becomes much more general. To demonstrate this, let's look



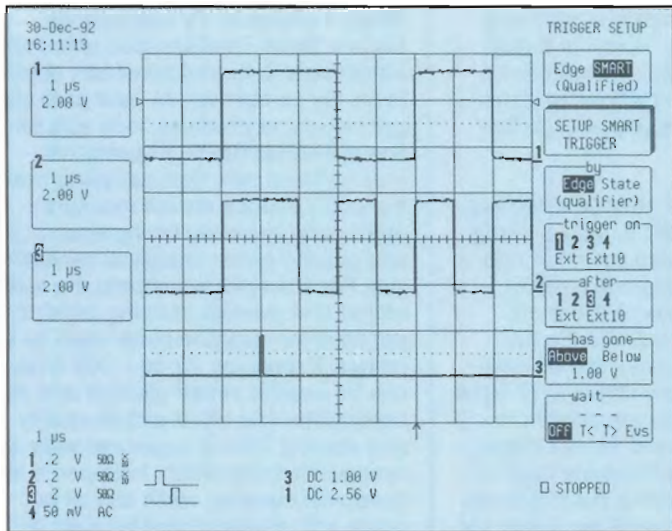

Figure 12: Logic Qualified (Pattern) Trigger: In this figure, acquisition is triggered on Channel 1's trigger conditions only after the signal on Channel 3 meets its own, independent set of trigger conditions. The trigger setup menu shows setup options, including delay (wait) by user-entered time or number of trigger events.

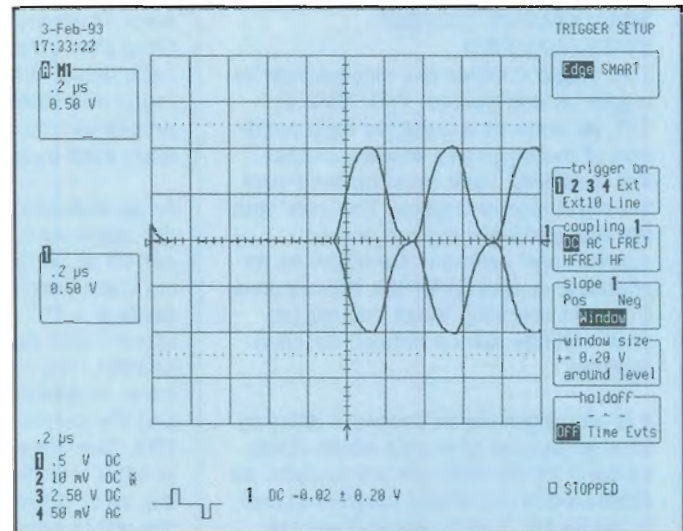

Figure 13: Example of bi-level trigger. The pattern trigger is set so that the scope can trigger on both the upper as well as the lower trace. While the lower trace shows Channel 1, the upper trace shows a previous event stored in memory M1. The arrow at the bottom of the screen shows the trigger time in both cases.

at an example which is of particular importance, that is a bi-level trigger (see Figure 13). Bi-level trigger means that the user wants the scope to trigger on a single-shot signal of unknown polarity and of roughly known amplitude.

This can be done by connecting the signal source to two inputs, for instance CH1 and CH2. Let's imagine setting the threshold of CH1 to +100 mV and the threshold of CH2 to -100 mV. Bi-level triggering occurs if the scope triggers on CH1 for any pulse greater than +100 mV OR on CH2 for any pulse more

negative than -100 mV.

**In Boolean notation we can write:**

Trigger = CH1 + CH2 (when entering the pattern).

By deMorgan's law this is equivalent to:

$$\text{Trigger} = \text{CH1} \cdot \text{CH2}$$

i.e., trigger on CH1 = low AND CH2 = high when exiting the pattern. This last configuration can be easily programmed. The possibility of setting the threshold individually for each channel extends

this method to a more general window trigger. In this case, to trigger the DSO the input pulse amplitude must lie within or outside a given window. Another important aspect of the pattern trigger is that all the features of the single-source trigger mode can also be applied. That is, the user again has the choice of imposing a hold-off by time or by number of events, or alternatively, of detecting durations or intervals which are greater or smaller than a time fixed by the user.

A warning should be given here about which time interval is compared to the reference time. The pattern trigger is designed to let the user always choose the trigger point. So if, for instance, LHX-entering is chosen, the trigger will occur as soon as the pattern LHX becomes true. If we now add the condition pattern width < reference time, the width which is compared to the reference time is the width of the pattern LHX complement preceding the trigger point. Therefore, this trigger mode checks the repetition time of the pattern.

On the contrary, if LHX-exiting, pattern width < reference time is chosen, then the duration of the LHX state will be compared to the reference time and the scope will trigger when LHX becomes false (A timing diagram is shown in Figure 14 and an example in Figure 15).

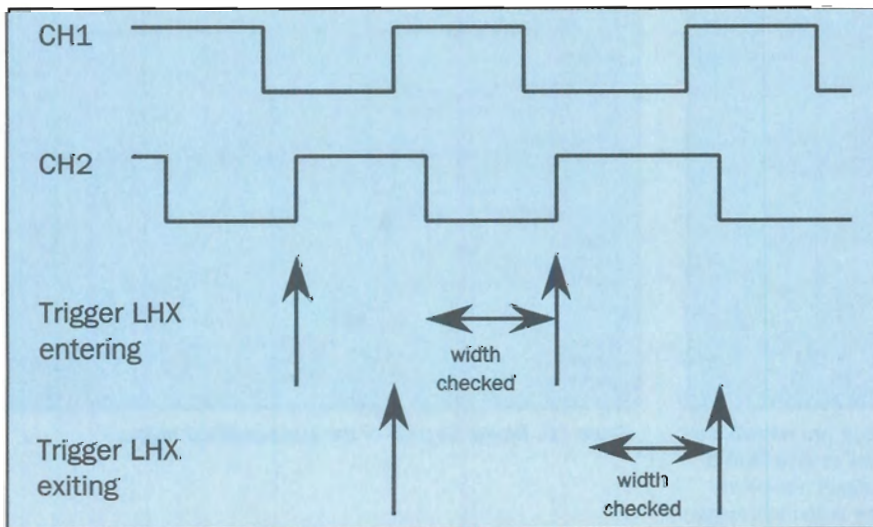

Figure 14: Timing diagram of the pattern trigger.



### MULTI-SOURCE TRIGGER - STATE-QUALIFIED

This trigger enables the oscilloscope to trigger on one source, CH1, CH2 or EXT, as soon as a selected logic condition of the other two sources exists. The qualifying state must be held until the oscilloscope triggers. The user sets the required logic pattern on two sources and uses this condition as an enable or a disable for the third source. Different coupling, slope and trigger level settings can be chosen for each channel.

It is also possible to choose a delay by time or number of events which starts as soon as the logic pattern is valid, as illustrated in the timing diagram shown in Figure 16. Typical applications for this trigger can be found wherever time violations occur, for instance in micro-processor debugging or in telecommunications.

### MULTI-SOURCE TRIGGER - TIME/EVENT (OR EDGE) QUALIFIED

This is another conditional trigger requiring a trigger source, CH1, CH2 or EXT, and a given logic state to occur on the three inputs. This trigger, unlike the state-qualified trigger, does not require that the qualifying logic state be maintained until the trigger occurs. From the moment that this logic state is present or absent, a delay can be defined in terms of time or number of events. When the delay has elapsed, triggering is enabled as shown in Figure 17. This feature provides a solution to applica-

tions which involve systems with long firing jitter time, e.g., lasers and magnetic discs. Other applications can be found in telecommunications or micro-processors for debugging of asynchronous data buses.

As an example of an edge-qualified trigger application, a DSO is set up to trigger off of the 5th pulse out of an optical shaft encoder. This pulse represents a 1.75° rotation of the shaft, where 1024 pulses represent a full rotation. The index pulse, the 0° reference, is applied to the DSO's CH2 input and the output pulses are applied to CH1. The edge-qualified SMART trigger is used with the positive-going edge of the index pulse, enabling the trigger on the positive-going edge of the signal on CH1. Hold-off by event is set to trigger after four trigger events. Thus, the oscilloscope triggers on the desired fifth positive-going edge. See Figure 18.

### TV Trigger

The user can decide whether he wants to trigger on every field, on either odd or even fields, or, when working with color TV signals, he can trigger on one of the four or eight color fields. This can be done for TV standards such as NTSC, PAL-M, PAL and SECAM-625.

Once the field has been selected, the user can selectively trigger on any line within the field.

When it comes to TV applications, LeCroy digital oscilloscopes offer many advantages over traditional test equipment. By combining pre- and post-trigger viewing capabilities, long acquisition memories (up to 2 Mword per channel) and very high sampling rates, the oscilloscopes enable measurements with improved timing accuracy and provide better analytical capabilities. For example, waveforms are easily stored and overlaid allowing rapid comparisons for measurements such as K ratings. Expansion (up to 1,000 times) can be used to reveal glitches and discontinuities that affect picture quality and stability. Timing measurements on sync width, burst width, front-porch and horizontal blanking width can all be made with greater precision even on single-shot acquisitions. And, an optional FFT (Fast Fourier Transform) Spectral Analysis package is available so that frequency, power and phase information can be revealed at the touch of a button.

The LeCroy 9300 series DSOs offer the most comprehensive trigger systems available in an oscilloscope. Versatility has been combined with user friendliness to provide instruments with exceptionally powerful triggers.

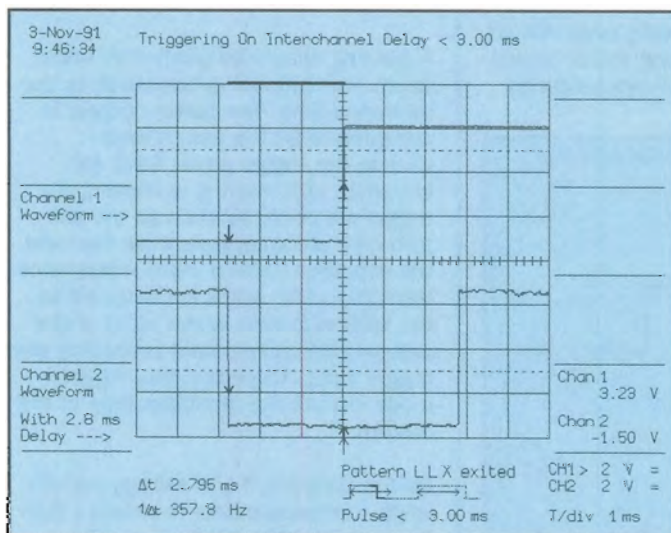

Figure 15: Example of triggering on the delay between two waveforms using pattern trigger. The DSO is triggered on a delay of less than 3 msec between Channel 1 and Channel 2. Pattern trigger has been set for triggering when Channel 1 and Channel 2 are both more negative than the trigger threshold levels for pulses narrower than 3 msec. Triggering will occur on exiting the pattern.

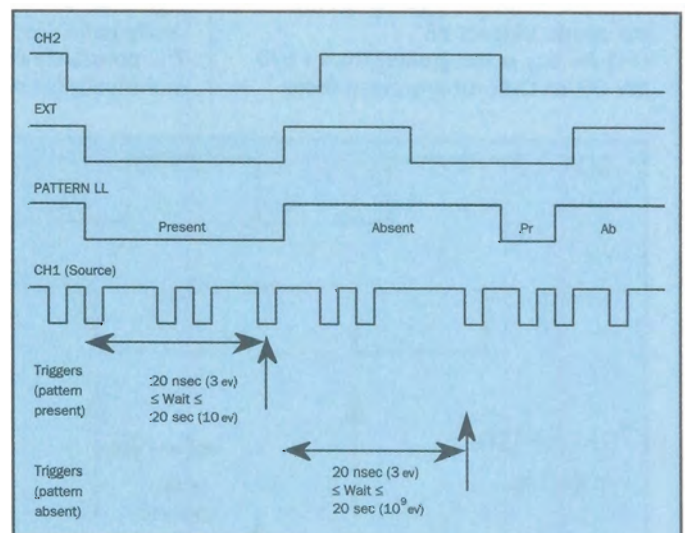

Figure 16: Timing diagram of the state-qualified trigger.



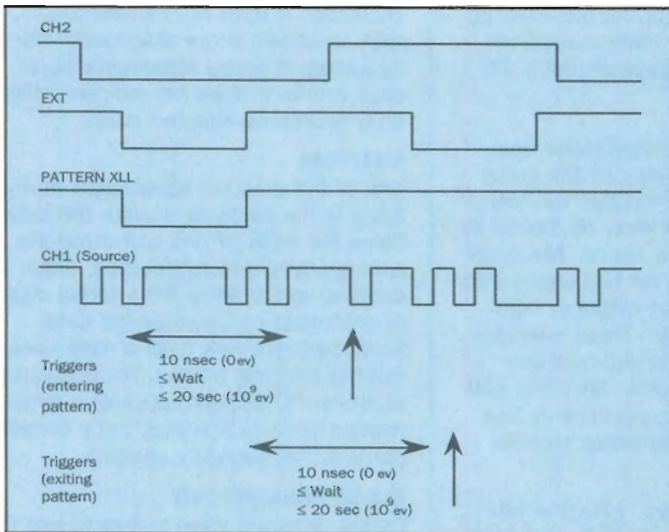

Figure 17: Timing diagram of the edge qualified trigger.

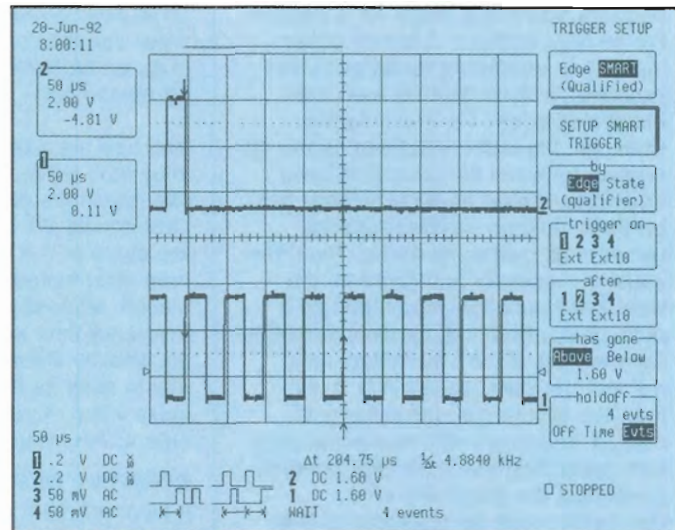

Figure 18: Example of edge-qualified trigger to find the 5th pulse after occurrence of fiducial event.

## DISPLAY

Analog oscilloscopes update 10 to 100 thousand times per second. Digitizers update much less frequently. Fast update rates give digitizers a “live response”, or an analog feel. If the response is too slow, the digitizer can miss changing or infrequent events, can be irritating to operate because of the lack of feedback, and can even provide erroneous results. Digitizer architecture, processor type(s) and speed(s), analysis algorithm efficiency, and display algorithm are determining factors in the display update rate.

## PROCESSOR SPEED

Microprocessors are used in most DSOs. They handle data transfers between memory, the display, any communication ports, and internal storage devices. They accept settings changes from the front panel controls or from the ports. In some cases, they control the waveform acquisition and configure advanced trigger settings. Their efficiency at manipulating data tremendously affects display update rates.

Use of multiple, fast-clocked, 32-bit processors plus dedicated digital signal processors can cause a digitizer to approach real-time update rates, even when extensive signal processing, such as FFT, is applied to the signal. Digitizer designs using a single, slow-clocked, 8-bit processor are less expensive, but can also make the instrument slow to operate.

## DISPLAY ALGORITHM

Use of dedicated display processors and simple long-memory compression techniques increases the display update rate. For example, if the CRT can display 2000 waveform points horizontally and memory holds 50,000 points, then only one out of each 25 points can be displayed. A simple display data reduction algorithm is to take every 25th point and display it. Although fast, this technique can miss important signal peaks and glitches. LeCroy’s proprietary “compaction” algorithm shows all the details and takes only slightly longer to run. High speed 32-bit processors minimize the effect of the additional calculations. Other display algorithms, such as smoothing or  $\sin(X)/X$  interpolation, require many calculations and, therefore, processing time.

## DYNAMIC ACCURACY

Accuracy consists of resolution, precision, and repeatability. Resolution indicates uncertainty associated with any reading. Precision indicates how well the reading matches the actual voltage. Repeatability indicates how often the same reading occurs for the same input.

All digitizers contain numerous measurement error sources which limit precision and repeatability. These errors include:

- Harmonic distortion
- Spurious response

- Differential non-linearity
- Noise (both amplitude and aperture jitter)
- Phase shift with frequency
- Amplitude and offset response with frequency

DC errors indicate how accurately the digitizer will measure static or slow moving signals. The input amplifier, not the ADC, determines DC accuracy. Analog oscilloscopes typically have 3% DC accuracy which matches the display errors. Digitizers can deliver better measurement accuracy, and thus should have better DC accuracy (typically 1-2%).

Dynamic accuracy represents DC accuracy plus numerous other error sources as well. Amplitude non-linearities result in harmonic distortion. These include static (DC) non-linearity, sometimes called integral non-linearity. Dynamic non-linearities, as can be induced by slew-limiting, contribute to harmonic distortion. All of these factors introduce spectral components into the digitized waveform data, at integral multiples of the input frequency. For example, for a 5 MHz sine input, 2nd and 3rd harmonic distortion adds 10 MHz and 15 MHz components to the original signal. Typically, dynamic non-linearities become larger for higher input signal frequencies and levels.

Differential non-linearity is a measure of the uniformity in the spacing of

adjacent quantizing levels for a digitizer. For an N-bit digitizer, 2 to Nth power minus one quantizing levels exist. For example, an 8-bit digitizer has 255 quantizing levels. For each digitizer code, the bin-width is defined as the difference between its upper and lower quantizing levels. An ideal digitizer has perfectly uniform, nominal spacing between all quantizing levels. The differential non-linearity is defined as the worst-case variation, expressed as a percentage, from this nominal bin-width. For example, if the LSB voltage is 2 mV and the worst case bin is 3 mV, then the differential non-linearity is 50%. A "missing code" has equal adjacent quantizing levels, or zero bin-width, precluding the possibility of the correct code being output at that input level. Differential non-linearity typically causes significant errors only for small signals since the error is usually only one count of the ADC.

Phase distortion means the digitizing system phase shifts the input signal different amounts at different input frequencies. Square pulse edges are composed of a spectrum of frequencies. The pulse waveshape is maintained only if the phase of all the sine components remains constant. Therefore, phase distortion induces erroneous overshoots and rise times on edges.

Amplitude noise is random or uncorrelated to the input signal. The amplifier associated with the digitizer generates noise into the digitizing process. Noise can mask subtle input signal variations on transient events. For repetitive signals, noise can be reduced by averaging several waveform acquisitions. A high resolution FFT plot of a digitized sine input indicates noise distribution, but it also indicates quantization noise. Even an ideal digitizer will have an FFT

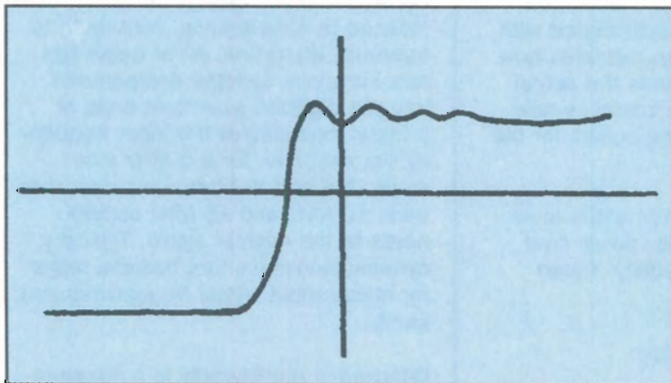

Phase distortion can cause pulse overshoot.

noise floor because of the quantization noise caused by the finite resolution (e.g., an ideal 8-bit digitizer has a -75 dB noise floor).

Aperture uncertainty represents sampling time noise, or jitter on the clock. The amplitude noise induced by clock jitter equals the time error multiplied by the slope of the input signal. The amplitude error increases for fast signal transitions, such as pulse edges or high frequency sine waves. Thus, aperture uncertainty affects timing measurements such as rise time, fall time, and pulse width. Aperture uncertainty has little effect on low frequency signals.

#### EFFECTIVE BITS

A figure of merit called "effective bits" provides a simple means of comparing the accuracy of two digitizers. It indicates dynamic performance. The effective bits measurement includes errors from harmonic distortion, differential non-linearity, aperture uncertainty, amplitude noise, and slewing. The effective bits measurement compares the digitizer under test to an ideal digitizer of identical range and resolution.

Effective bits as a performance indicator has many drawbacks. Effective bits measurements change with input frequency and amplitude. Since the effects of harmonic distortion, aperture uncertainty, and slewing increase at higher signal frequencies and amplitudes, the effective bit values decrease. To represent overall performance under a wide variety of conditions, effective bits should be plotted for various frequencies and amplitudes.

The effective bits indicator is calculated using sine wave inputs.

Therefore, it does not include phase, gain, or offset errors which vary with frequency. It poorly represents worst case errors. It does not indicate which error source contributed most.

#### ANALYSIS

One of the greatest advantages of digitizing is the ability to analyze the data. Since the digitizer has converted the analog signal into digital data, either an external computer or the internal digitizer processor can analyze the data. Most digitizers now have a wide spectrum of analysis built in. For additional analysis, PC software packages simplify custom array processing. Let's consider some of the available analysis.

#### PULSE PARAMETERS

Cursor readouts allow a user to use the full resolution of the ADC to measure absolute and relative times and amplitudes on a waveform. However, most users commonly measure the same parameters on a waveform. These parameters include rise time, fall time, pulse width, overshoot, undershoot, peak voltage, peak-to-peak voltage, maximum, minimum, standard deviation, rms value, frequency, and period. The IEEE-194-1977 Standard defines how to make these pulse parameter measurements.

#### WAVEFORM MATH AND ENGINEERING UNITS

Waveform math allows the user to display final answers, rather than raw data. For example, inputs from voltage and current transformers can be multiplied together to display power. LeCroy scopes have a very important feature

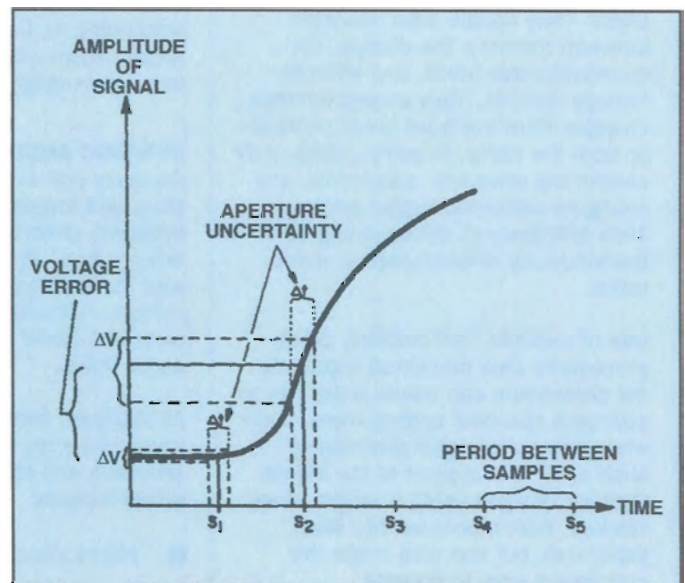

Aperture uncertainty causes errors on fast edges.



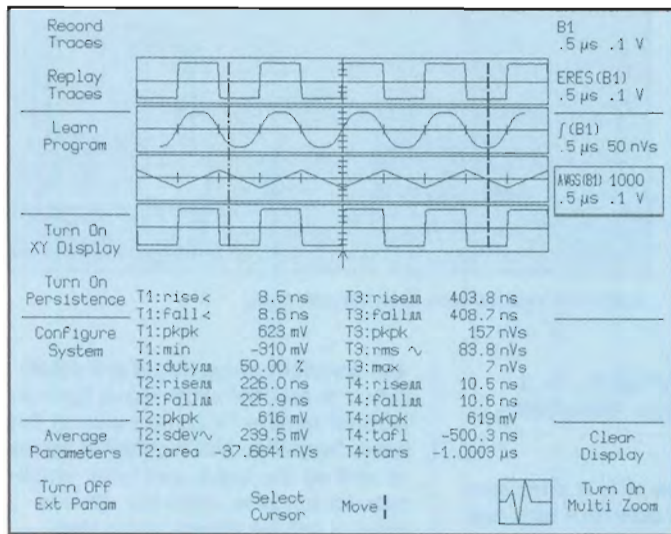

Automatic pulse parameter readout in a 7200A.

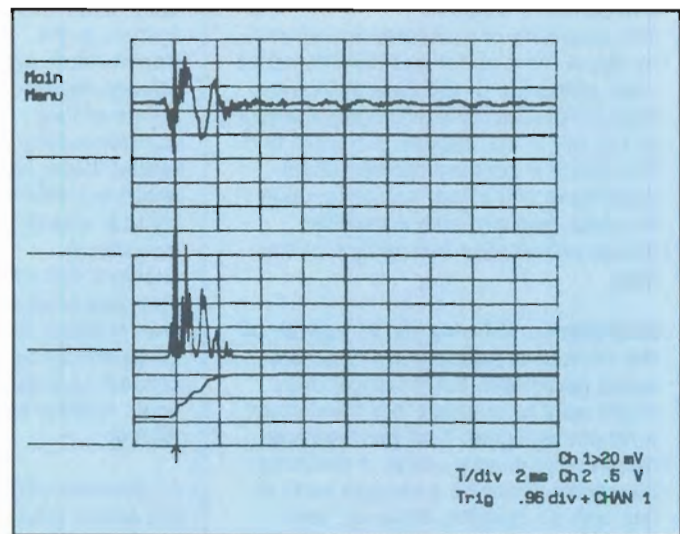

Figure 19: Current and voltage waveforms multiplied and integrated to display total energy.

which is the ability to daisy chain math functions. For example, the power trace can be integrated to display energy (Figure 19).

### SIGNAL VARIATION

Digitizers can accurately indicate subtle changes in a repetitive signal via either a roof/floor envelope or a persistence mode (e.g. "eye diagrams"). The roof/floor envelope, also called "extrema", records and displays the maximum and minimum values for each point. Persistence mode displays the last N waveforms acquired, where N is a user selectable number. The

persistence mode indicates the density of occurrences, extrema does not.

### FREQUENCY DOMAIN

The Fourier transform converts sampled waveform information into a unique set of sine wave components. The data is usually plotted as frequency vs. amplitude. Two algorithms are common: the discrete Fourier transform (DFT) and the fast Fourier transform (FFT). Practical implementations use the FFT since it is many times faster to calculate. The FFT can expose information not easily visible in the time domain (time vs. amplitude).

Ideal uses for FFT analysis include measuring frequency components of communication signals, monitoring drift in a oscillation, etc. The frequency resolution of an FFT is directly proportional to the number of time domain points the FFT algorithm can handle. Some companies make scopes with 500k points but their FFT algorithm can accept only 10k. Those scopes have 1% as much resolution as a LeCroy scope which can perform 1 million point FFT's.

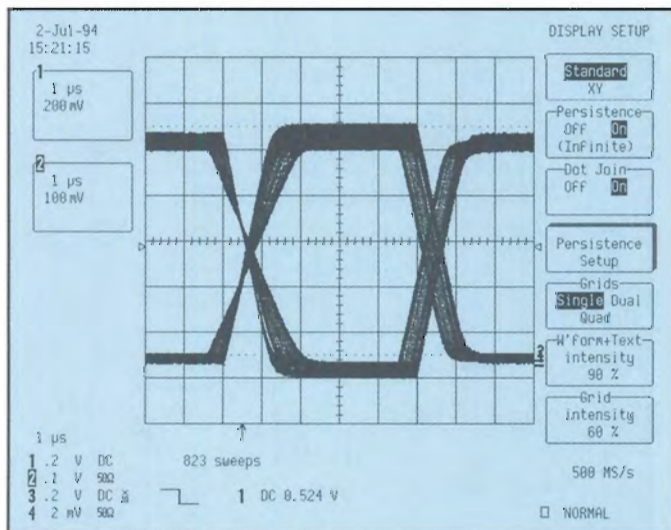

Persistence mode displays a user-selected number of sequential measurements.

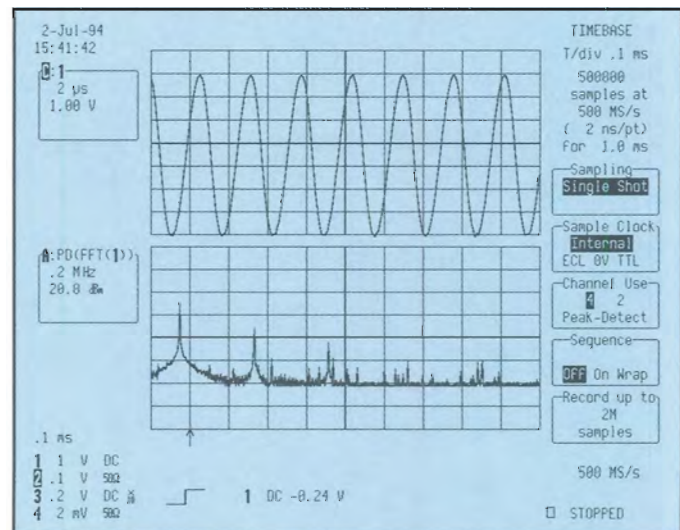

FFT of sine wave shows harmonics not visible in time domain.



### STATISTICAL DOMAIN

The existence of measured waveforms in digital representations permits convenient utilization of the data inherent in those measurements. Besides analysis of signals in the frequency domain and the ability to perform mathematical operations and signal averaging upon the data, one can also determine trends and analyze histograms of the data.

**Histograms:** A histogram is a graph of the number of occurrences of a measured parameter. For instance, one might want to measure the risetime of a repetitive signal. If all the measurements were exactly equal, a resultant histogram would be a straight vertical line with no breadth. However, variations in the risetimes create a plot with some horizontal structure, implying variations in the measurements. Certain LeCroy oscilloscopes not only create such histograms but also allow measurement of their own characteristics.

### AUTOMATING TESTS

Almost all digitizers can be controlled from a host computer across the GPIB (IEEE-488 Standard Interface bus). The IEEE-488.2 Standard specifies command structure for common digitizers settings, such as voltage range, sample rate, etc. Therefore, digitizers which conform to IEEE-488.2 have easily understood, English-like, mnemonic commands.

One of the problems associated with high-accuracy digitizers in a GPIB-based

automated test system is the transfer time and storage requirements of long waveform data blocks. Local data analysis within the digitizer allows for transfer of answers, not extensive data blocks. This analysis can be as simple as calculating pulse parameters. Or it could actually consist of PASS/FAIL testing.

A "save-on-delta" type of test compares the actual waveform against a high and low limit. The limits are set as tolerances compared to a reference waveform. If the acquired data passes outside the limits, the digitizer can take an action (beep, GPIB SRQ, etc.).

Some digital oscilloscopes may contain a more flexible and powerful test than envelope limits checking. In the 9300 series, for instance, different pulse parameters can be measured on the acquired data. Each parameter can have its own tolerance. For example, the digitizer could act if:

Rise time exceeds a 5% tolerance AND overshoot exceeds 2% OR frequency varies by 0.5% OR the third harmonic is larger than -42 dB.

In Figure 21, both a tolerance mask

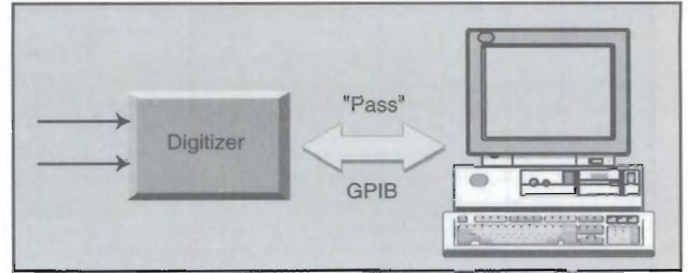

Local analysis reduces data transfer time.

and waveform parameters are established to test the drive signal from an infrared remote TV control unit. In this case, frequency and number of cycles as well as the upper and lower amplitude versus time limits are used to pass or fail the device under test.

The test conditions are completely programmable, and therefore completely flexible. The actions taken can include printing the data, printing a report, saving the waveform to disk, polling the GPIB SRQ line, modifying its own setup and taking a different measurement, beeping, turning on an external device, etc.

### STORING & RECALLING WAVEFORMS & PARAMETERS

A few digital oscilloscopes have built-in mass storage for storing large numbers of waveforms. The capability is powerful and time saving. An internal floppy drive and hard disk can store and recall waveforms, setups, measured parameters, and test programs, or can continu-

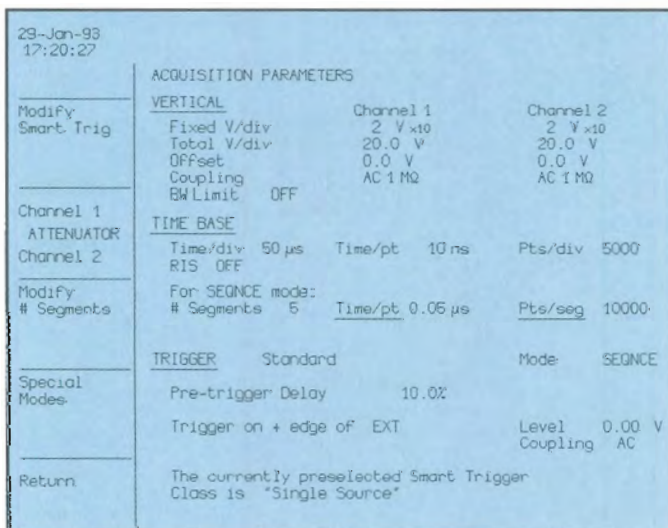

Non-volatile storage and recall of complete configurations simplify setup changes.

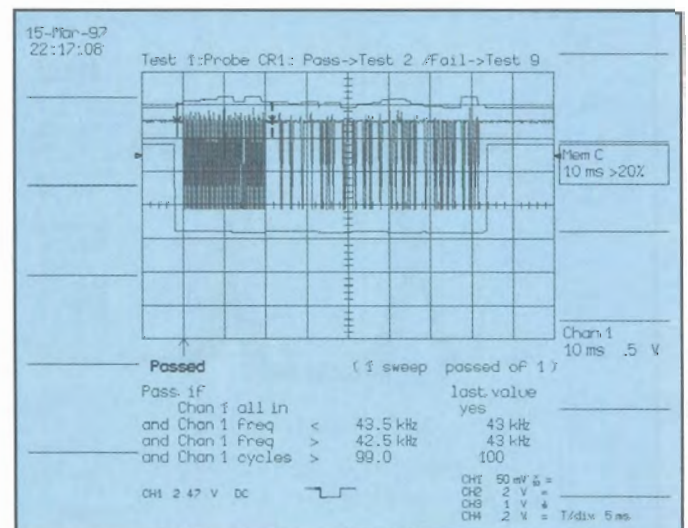

Figure 21: Testing an infra-red remote control unit. Note the simultaneous use of both parameters, such as frequency and number of cycles, and tolerance mask testing. Pass/Fail tests can incorporate up to 5 user-defined test conditions.



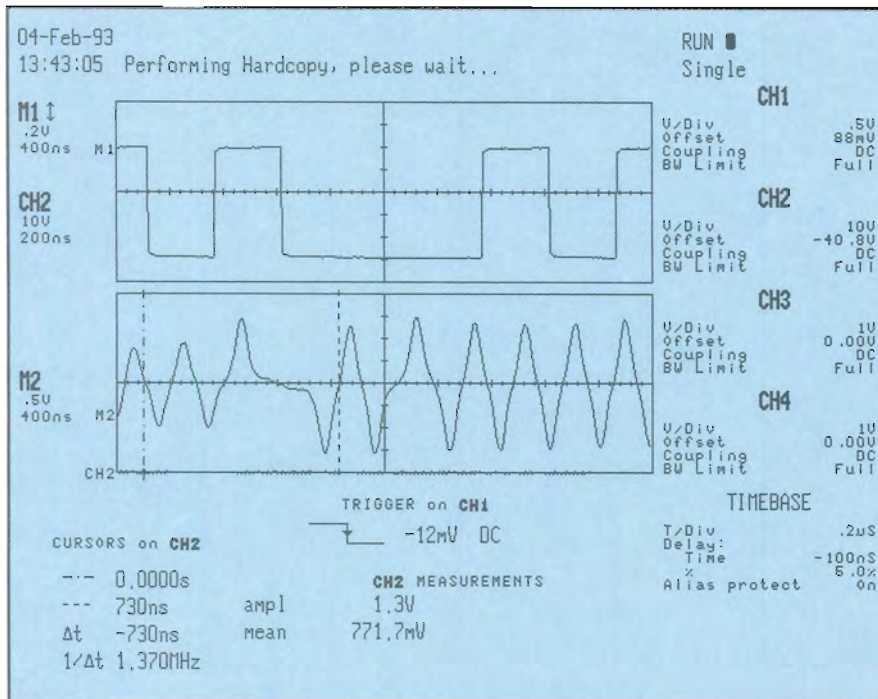

Figure 22.

ously record every waveform displayed. In the latter case, this "record" mode can be exited and the stored waveforms scrolled back onto the screen, one at a time.

Many DSOs now offer built-in floppy disks and RAM memory cards, all in DOS-compatible format. After storing waveforms, the memory card or diskette can be removed from the oscilloscope and transferred to a PC for further storage, manipulation, or network transfer, or can be carried over to or copied for other test, field service, or R&D stations. Absolute consistency can be maintained in testing via this method, as all locations share the same waveform files.

Most digital oscilloscopes have GPIB or RS-232C output as standard or optional. Direct fax connections are available on others. File formats are becoming increasingly PC-software compatible, with the LeCroy DSO ScopeStation Series outputting measurements in formats directly importable into word processor, spreadsheet, database, math package, and design simulation software. Figure 22 shows the result of a screen printout to a .PCX format file. Note that the main settings for each channel are given to the right of the screen.

Besides storage and transfer to memory devices, LeCroy digital scopes offer push-button transfer of waveforms and settings to LW400 series Arbitrary Waveform Generators. This facility enables reference waveform, for instance, to be captured from a known good device and be used as a test stimulus applied to other devices.





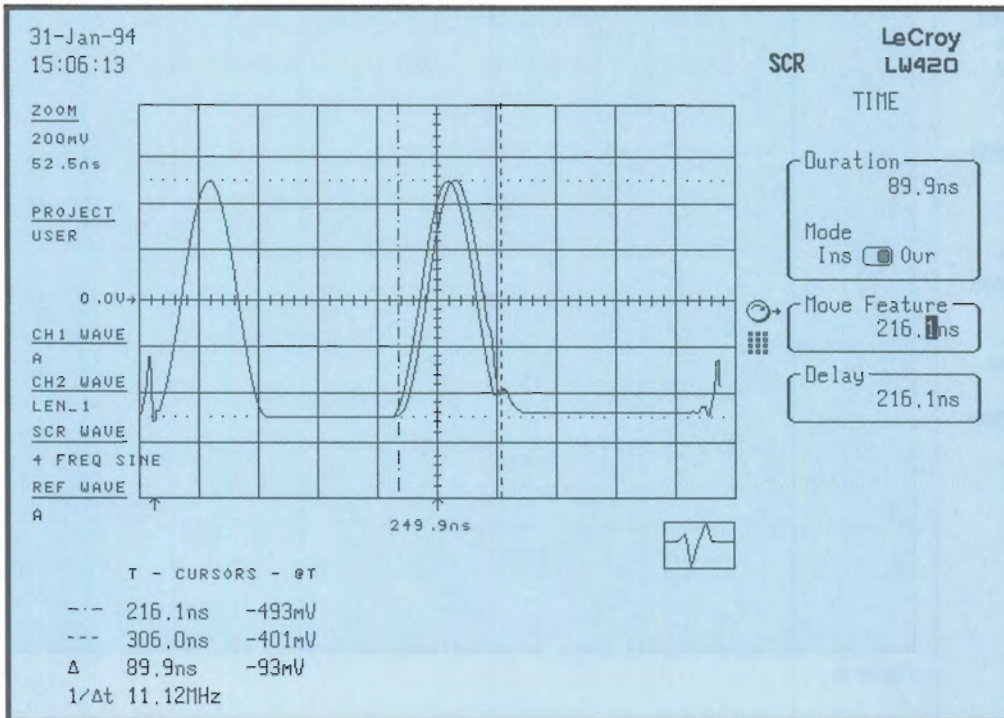

## Waveform Creation Made Easy

This technical note discusses how an Arbitrary Waveform Generator (AWG) can be used to perform the types of tests most common to engineering and test. Emphasis is made on new software and hardware technology that makes the job of generating test waveforms easier and faster.

After an introduction which discusses how waveform features can be moved and how to avoid signal discontinuities, there are specific examples of waveform creation for quadrature signal generation, pulse strings, bit jitter tolerance testing, creating jitter to specification and a variety of standard waveform elements that can be used to create signals.

## Introduction

### MOVING WAVEFORM FEATURES IN SMALL INCREMENTS

One of the most interesting capabilities of arbitrary waveform generators (AWG's) is the ability to time shift or scale waveform features such as edges and peaks by time increments significantly less than the sample clock period. Users of high performance AWG's have used a calculation intensive version of this technique for years to simulate sub nanosecond shifts in disk drive and data communications waveforms. The LeCroy WaveStation LW420, the latest and most advanced AWG from LeCroy, brings this capability to new levels of accessibility and useability. Tedious off-line computations have been replaced by a single, interactive control on the front panel.

The LW420, using a maximum sample clock rate of 400 MS/s (2.5 ns sample period), is capable of moving waveform features by an increment as small as 100 ps with a simple, single knob control. The figure above, from the LW420's front panel display, shows a pulse being moved within a waveform. Time cursors bracket the segment to be moved. Move Feature is chosen from the Time Edit menu and the segment is moved by varying the main control knob or by entering the desired time shift using the numeric keypad. Note that the Time Edit menu also includes the ability to modify the duration (time scale), and to delay (time shift) the waveform. Each edit action features a minimum time increment of 100 ps.

While the technique is implemented using some very sophisticated signal processing, the basic concept of sub-sampling interval waveform modification is very simple. Consider the two waveforms shown in Figure 1 on the next page. There are two ways to add a time delay to a waveform. Samples can be delayed in time by multiples of the sample clock period. This technique works well for large delays and is very simple.

The LW420 uses this technique for coarse movement of waveform features. Finer delay increments are achieved by changing the amplitude of the samples to correspond with the amplitudes of the the desired sample points on the delayed waveform.

For example, if the amplitude at each sample point in the figure is moved to the amplitude of the delayed waveform, then the resultant waveform is moved later in time by "t" seconds. This is indicated, in the figure, by the arrows which show the amplitude changes necessary to move from the original to the delayed waveform. The vertical resolution, one part in 256 for an 8 bit system, offers significantly finer placement of each point on the waveform than shifting by the sample clock period. The correct amplitude value corresponding to a desired time delay is determined by numerical interpolation using advanced signal processing techniques.

Other processing methods are used to optimize the transition points to minimize signal discontinuities. All of this processing occurs so fast that the changes, controlled by front panel knob, appear at the output as the knob is turned.

The oscilloscope display shown in Figure 2 illustrates the results of the waveform time shift operation. It shows overlaid pulses, from the LW 420, being shifted by increments of 2, 3, 3.5, and 3.7 ns. Note that the effect is to translate the waveform in time without changing or distorting the waveform in any way.

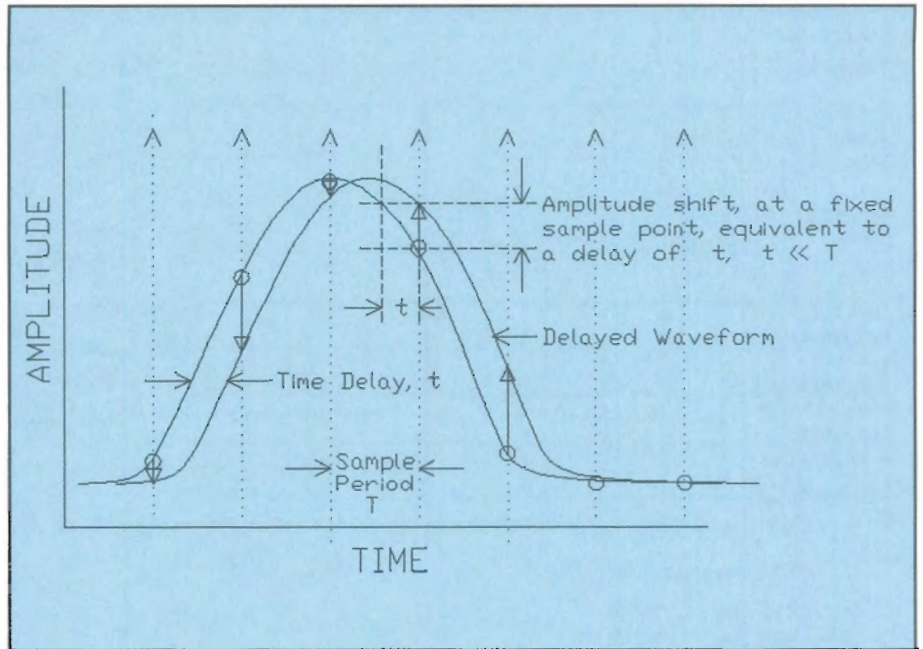

Figure 1.

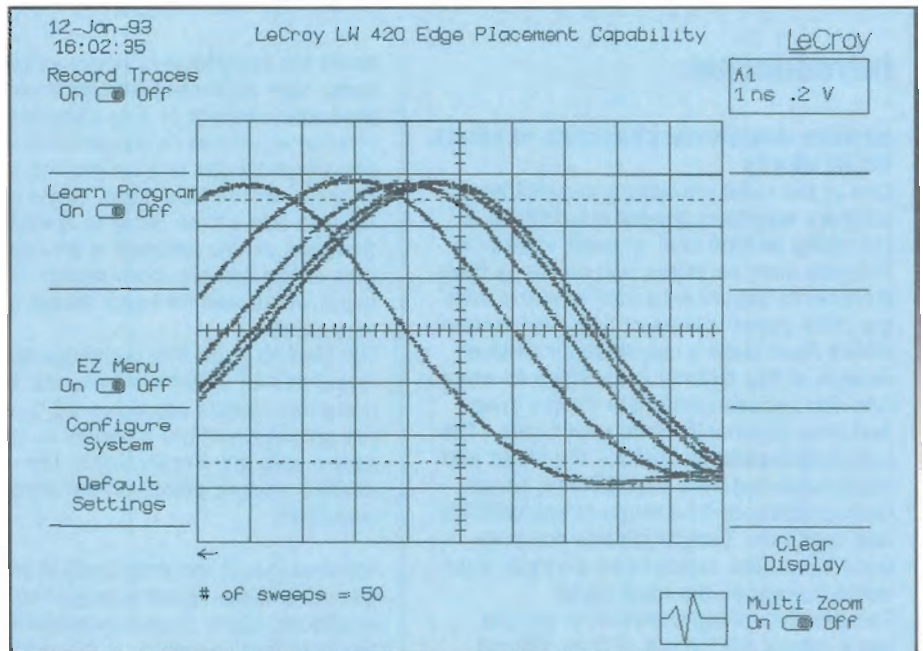

Figure 2.



## Preventing Signal Discontinuities (Nyquist Violations)

The LeCroy WaveStation LW400 Series arbitrary waveform generators use advanced signal processing techniques to perform live waveform manipulations, such as duration

ply output as an analog waveform. The bandwidth would be limited by the output circuits. However, to achieve the benefits of live waveform manipulation, the waveform must be processed further. For example, to move the edge in 100 ps increments, the data must be passed through a Sin(x)/x, finite impulse response (FIR), digital filter. The Sin(x)/x inter-

of the time displacement. Automatic bandlimiting eliminates this response and produces a clean transition with minimum overshoot and ringing.

When a discontinuity is detected the data samples are passed through an FIR smoothing filter shown in the block diagram of Figure 4 on the next page. The three coefficient filter converts the input discontinuity, such as a step waveform, into a ramp function.

The smoothed output data can be used in the Sin(x)/x interpolator without the aberrations described earlier. The entire process is totally automatic and transparent from the users point of view. The response of the LW400 interpolator to both the smoothed and unsmoothed data is shown in Figure 5. The smoothed data exhibits almost no overshoot. This response minimizes changes in the waveform shape when sub-sample delay, move and duration changes are evoked.

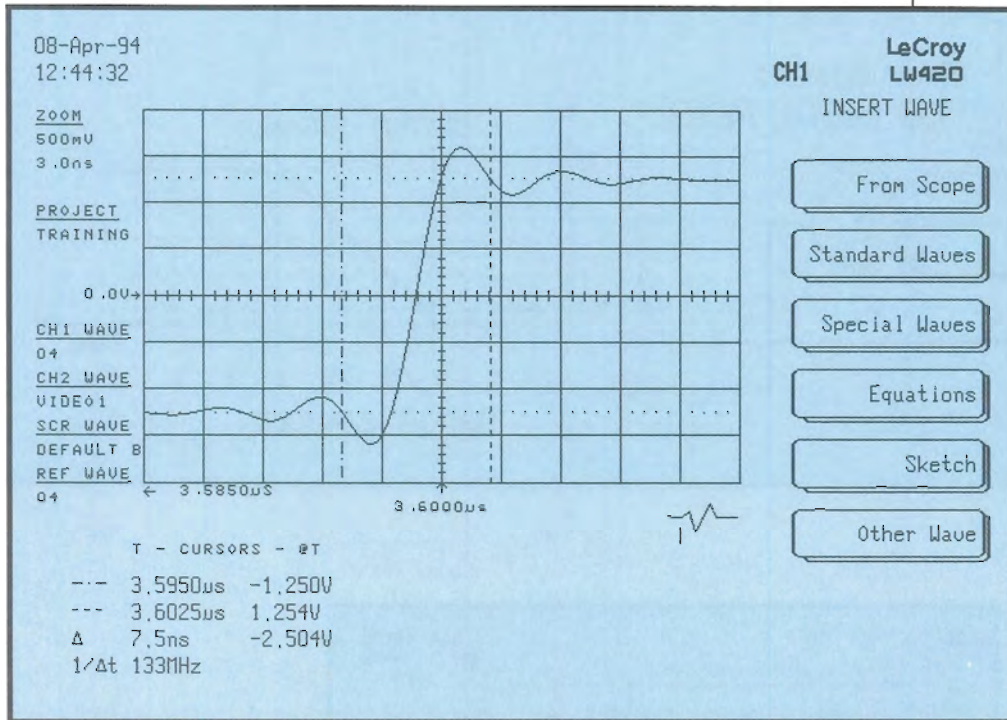

Figure 3.

change, move, and delay with 100 ps time resolution. The interpolation and resampling processes used to perform this task require properly bandlimited data to produce clean, aberration free output waveforms. Waveform editing, a process common to all AWG's, can be the source of signal discontinuities which violate the Nyquist criteria resulting in undersampled data. The LW400 includes an automatic bandlimiting algorithm which locates and eliminates such discontinuities arising from editing, waveform mathematics, or other sources.

Waveform editing operations such as deletions (cut) and insertions (paste) can produce step changes that occur in less than one sample period. For example, a step waveform within the 2.5 ns sample period of the LW400 has a bandwidth in excess of 1 GHz. This type of discontinuity would generally cause little problem if it were sim-

polation filter is used because of its flat frequency response out to the Nyquist frequency limit. It also has the property of passing input sample points through to the output if they occur at the identical time. The only draw back of this type of filter is a step response that exhibits overshoot and ringing. If a step discontinuity is applied to the filter input, then the output is shown by the adjacent figure. The filter produces an output where all the output sample values match the desired input sample amplitudes. Two such points are identified by the time cursors on the display. Between the samples the waveform will exhibit the aberrations shown in Figure 3. This is the step response of the digital filter. These values will be seen at the output as the waveform is moved in time by less than a sample period. The result would be an output level that varied in amplitude as a function

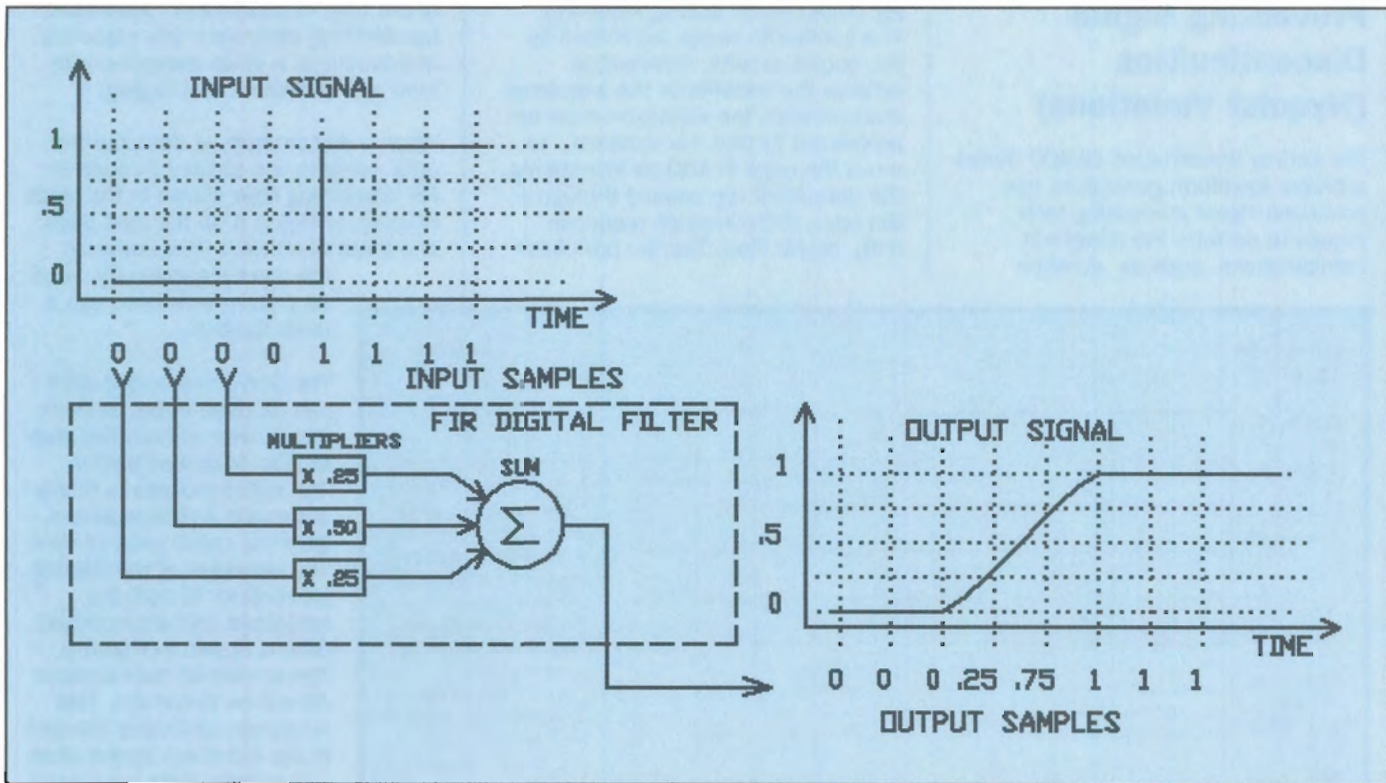

Figure 4.

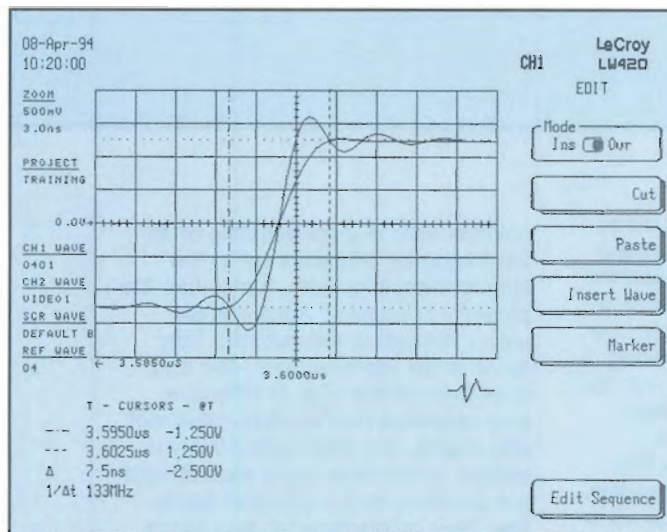

Figure 5.



## Quadrature Signal Generation - Simulating Phase Encoded Data

Dual channel arbitrary waveform generators (AWG's) are ideal for simulating quadrature signal generation processes. Mixed analog/digital waveform creation coupled with waveform math and precise time, phase, and amplitude modification capabilities offer a full range of functional and margin test opportunities.

Consider the quadrature phase shift keyed (QPSK) system shown in the block diagram of Figure 6. The QPSK output is the sum of dual binary phase shift keyed (BPSK) generators using quadrature local oscillator (LO) signals. A LeCroy WaveStation, LW420, can be used to replace any, or all, of the system blocks to provide signals with a full range of variability to simulate worst case changes in amplitude, phase, frequency, or signal to noise ratio.

Figure 7 shows the I and Q data signals as they would appear at the output of the level shifters in the block diagram. These waveforms were created in the LW420 using the dual channel outputs. Signals can be created from standard wave shapes, equations, or imported from digital oscilloscopes. Independent waveshapes, sharing a common output clock, guarantee correct synchronization. 100 ps edge time resolution in varying edges

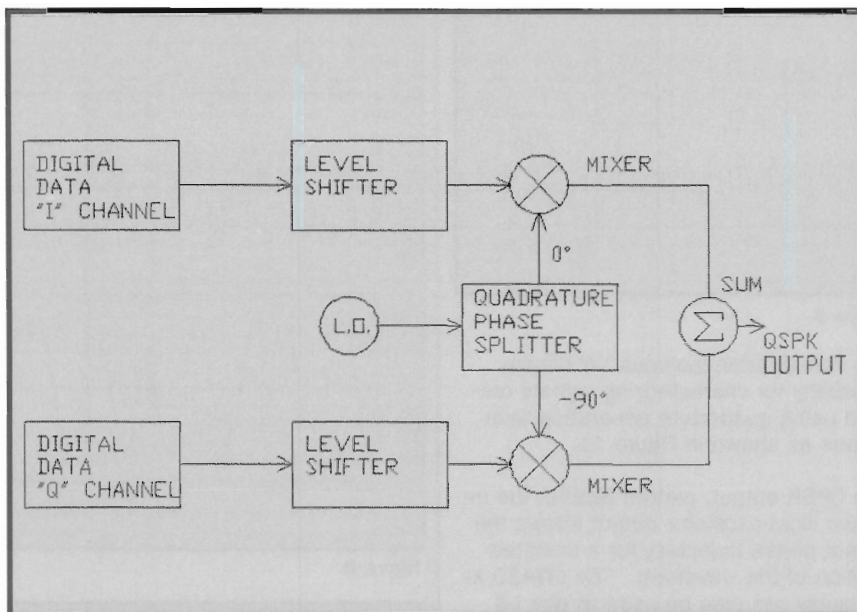

Figure 6.

position and duration make it easy to simulate jitter and variations in edge rate.

The local oscillator outputs are created using the standard sine function. In addition to the amplitude, frequency, and number of cycles parameters, the standard sine includes the start phase, settable to 0.01 precision (see Figure 8). This parameter was used to create the -90° phase shift for the quadrature local oscillator output. These waveforms can also be created using equations. Waveforms created using equations can be phase shifted

by adding the phase offset in the function argument. For example, LW420 equations,  $\text{SIN}(2*\text{PI}*T*1\text{M})$  and  $\text{SIN}(2*\text{PI}*T*1\text{M}+\text{PI}/2)$  are 90° out of phase as are  $\text{SIN}(2*\text{PI}*T*1\text{M})$  and  $\text{COS}(2*\text{PI}*T*1\text{M})$ .

The outputs of the I and Q mixers are obtained by using the LW420 waveform mathematics (Wave Math) to multiply the data and corresponding local oscillator signals. The resultant I and Q BPSK waveforms, shown in Figure 9, are then added to produce the QPSK output waveform. Wave Math operates on entire waveforms and include standard arithmetic functions, integration, differentiation, and convolution.

Figure 10 shows the QPSK output signal. In addition to the waveform manipulation operations which were mentioned previously, uncorrelated Gaussian noise, at user specified relative amplitude, can be added to the output. This permits testing the effect of signal to noise ratio on detector performance.

The LW420 has 5 linear phase low pass filters with bandwidths of 100MHz to 10 kHz in decade steps. It automatically selects a filter appropriate for the sample rate. If necessary a lower bandwidth may be selected.

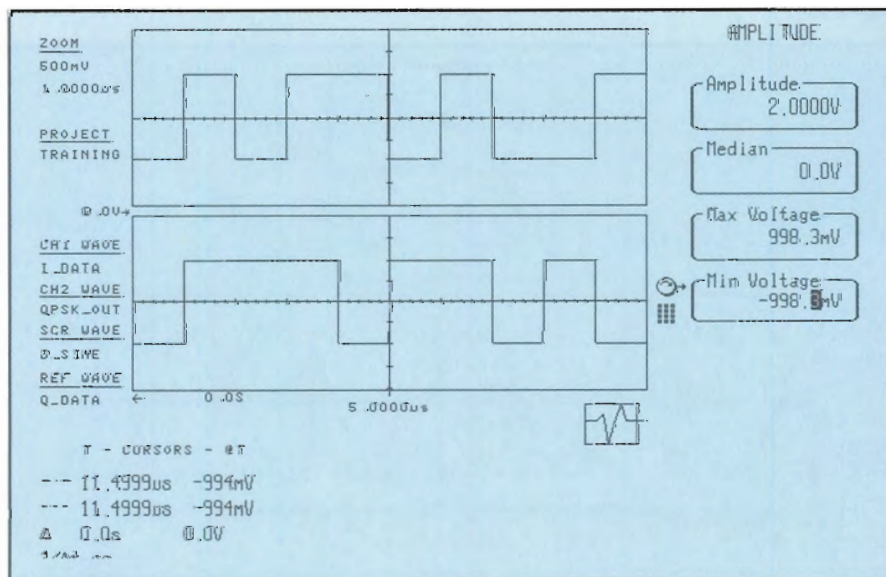

Figure 7.

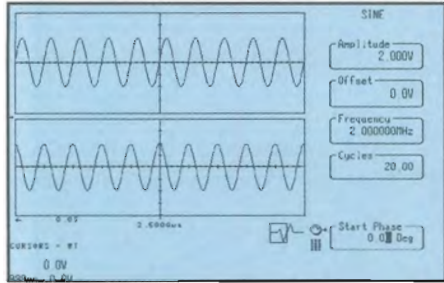

Figure 8.

The WaveStation includes X-Y display capability for characterizing signals created using quadrature generation techniques as shown in Figure 11.

The QPSK output, plotted against the in-phase local oscillator output shows the output phase trajectory for a selected section of the waveform. The LW420 X-Y display can also be used to plot I-Q diagrams for visually determining output phase angle and signal magnitude.

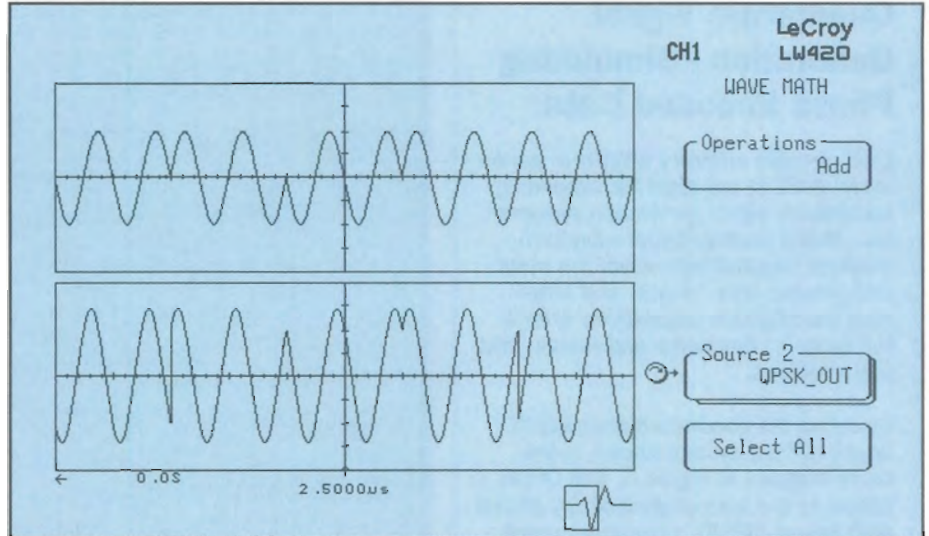

Figure 9.

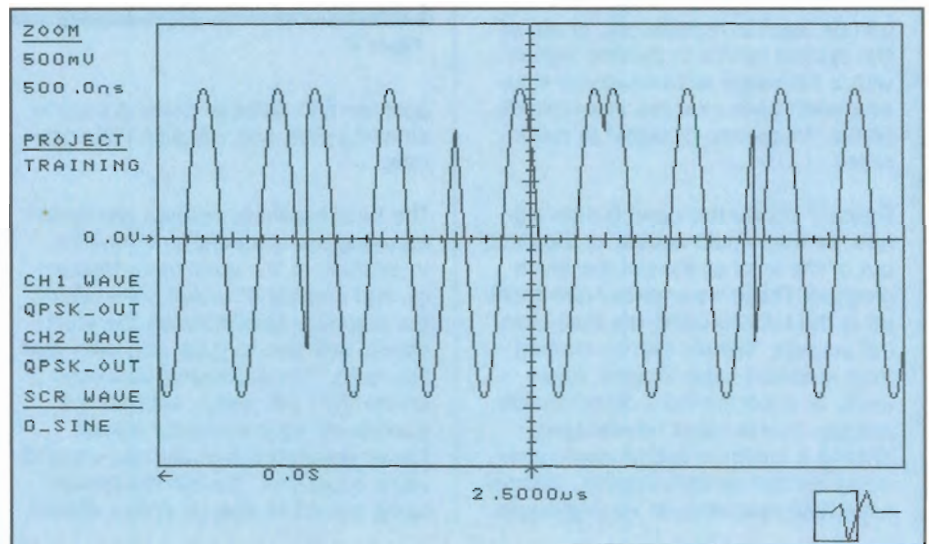

Figure 10.

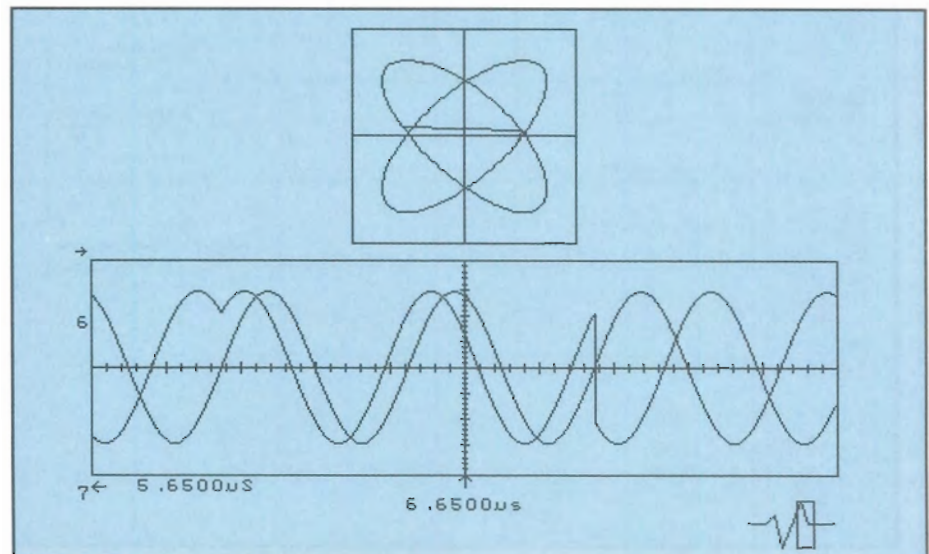

Figure 11.



## Generating Pulse Trains with an AWG

Many electronic applications require non-standard pulse waveforms. Periodic pulses, with multiple levels, controlled amounts of noise, and added or missing pulses are difficult to obtain from conventional pulse generators. The LeCroy WaveStation, LW400, series of AWG's are ideal sources of both special and standard pulse waveforms. Non-standard pulses can be created by combining standard waveforms or by describing them by equations. The following examples illustrate several approaches used to create special pulses using equations.

The basic pulse waveshape (Figure 12) can be described by combining two, time delayed, unit step pulses. Each step function describes an edge of the pulse. In the LW400 AWG this is expressed as:

$$\text{STEP}(T-3.5\mu) * \text{STEP}(6.5\mu-T)$$

where:  $\text{STEP}[f(t)] = 0$  for  $f(t) < 0$   
and  $\text{STEP}[f(t)] = 1$  for  $f(t) \approx 0$

Or its equivalent PULSE function in the form:

$$\text{PULSE}(3.5\mu, 6.5\mu)$$

A repetitive pulse is created by using a periodic function as an argument in the step or pulse functions as is shown in Figure 13.

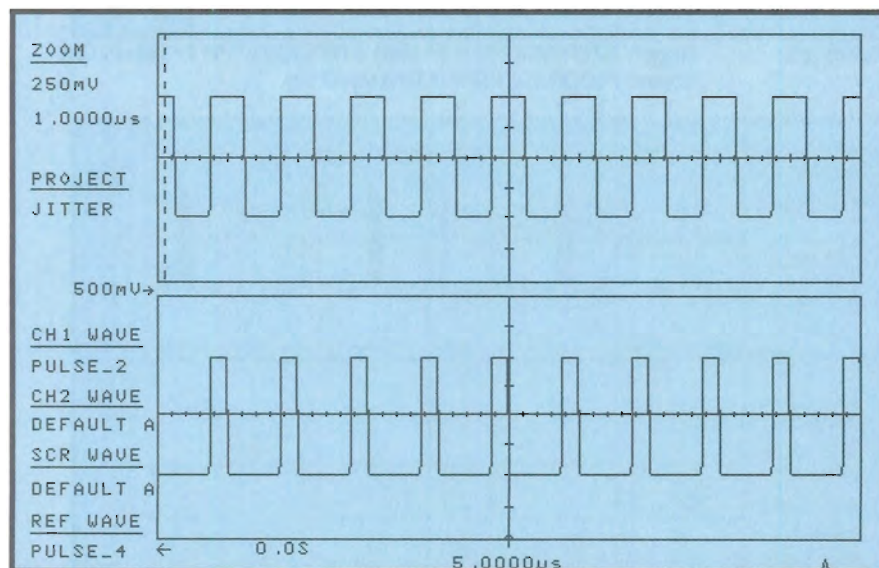

Figure 13.

Upper:  $\text{STEP}(\text{SIN}(2*\text{PI}*T*1\text{M}))$   
Lower:  $\text{PULSE}(\text{SIN}(2*\text{PI}*T*1\text{M}), \text{COS}(2*\text{PI}*T*1\text{M}))$

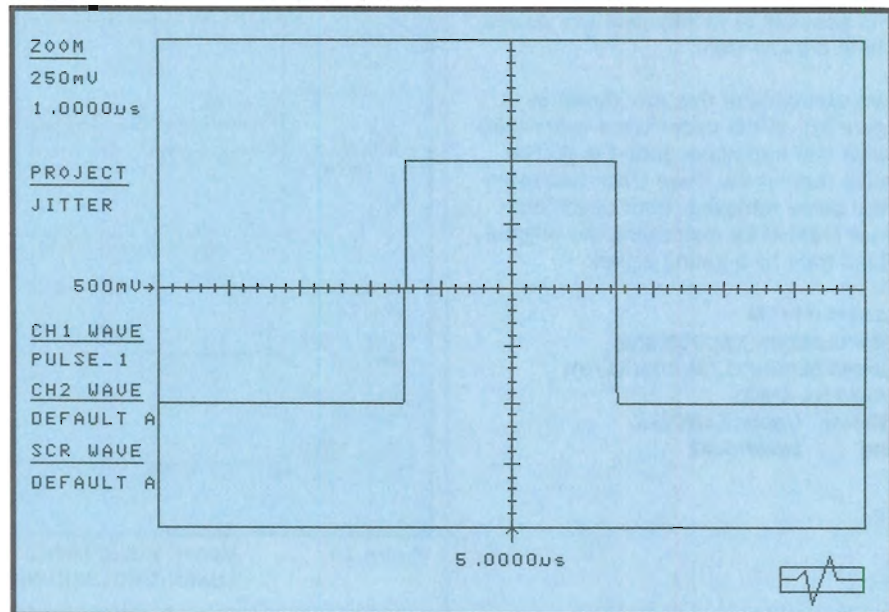

Figure 12.

PULSE (3.5µ, 6/5µ)

The upper trace is a square wave created by using a 1 MHz sine wave as an argument of a step function:

$$\text{STEP}(\text{SIN}(2*\text{PI}*T*1\text{M}))$$

In the lower trace, 2 periodic arguments were used in the pulse function to create an asymmetric pulse:

$$\text{PULSE}(\text{SIN}(2*\text{PI}*T*1\text{M}), \text{COS}(2*\text{PI}*T*1\text{M}))$$

The duty cycle of the pulse train is

determined by the phase relationship of the functions chosen for the arguments.

The duty cycle of a pulse described by,

$$\text{PULSE}(\text{SIN}(2*\text{PI}*T*1\text{M}), \text{SIN}(2*\text{PI}*T*1\text{M}+\phi))$$

will vary from 50% to 0% as the phase offset,  $\phi$ , changes from 0 to  $\pi$  radians. Duty cycles in the range of 50% to 100% are created by taking the complement of this pulse using the equation:

$$\text{1-PULSE}(\text{SIN}(2*\text{PI}*T*1\text{M}), \text{SIN}(2*\text{PI}*T*1\text{M}+\phi))$$

The duty cycle now varies from 50% to 100% as the phase offset is changed from 0 to  $\pi$  radians (Figure 14 lower trace).

Multi-level pulses can be created in many ways. A simple method of creating a bipolar, tri-level pulse analytically is to use the following equation:

$$\text{STEP}(\text{SIN}(2*\text{PI}*T*1\text{M})) - \text{STEP}(\text{SIN}(2*\text{PI}*T*1\text{M}+\text{PI}/2))$$

An alternative technique is to use the integer floor function with an amplitude offset sine wave:  
 $\text{FLOOR}(\text{SIN}(2*\text{PI}*T*1\text{M})+0.5)$   
The width of the positive and negative pulses will depend on the value of the offset.

It is possible to modify selected pulses within a pulse train.

Two examples of this are shown in figure 16. In the upper trace every third pulse has had noise added to it. The pulse train in the lower trace had every third pulse removed. Both conditions were created by multiplying the original pulse train by a gating signal:

$$X1=2*PI*T*1M$$

$$X2=PULSE(SIN(X1),COS(X1))$$

$$X3=PULSE(SIN(X1/3),COS(X1/3))$$

$$X4=X2*(1-K*X3)$$

Where: Upper:  $K=NOISE$ ,  
and Lower:  $K=1$

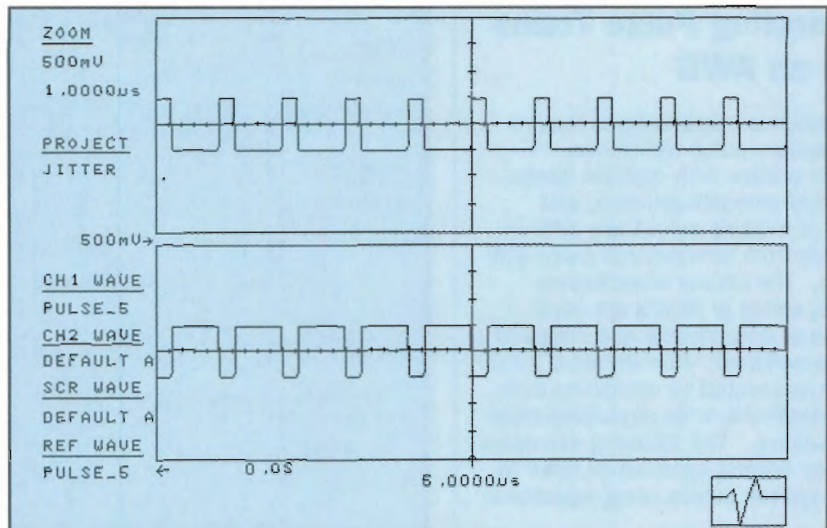

Figure 14.

Upper:  $PULSE(SIN(2*PI*T*1M),SIN(2*PI*T*1M+PI/2))$   
Lower:  $1-PULSE(SIN(2*PI*T*1M),SIN(2*PI*T*1M+PI/2))$

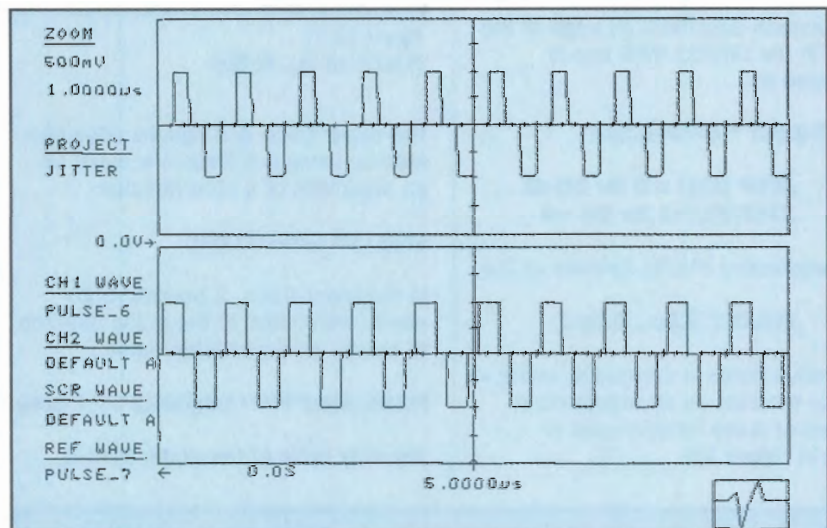

Figure 15.

Upper:  $STEP(SIN(2*PI*T*1M)) STEP(SIN(2*PI*T*1M+PI/2))$   
Lower:  $FLOOR(SIN(2*PI*Ti*1M)+0.5)$

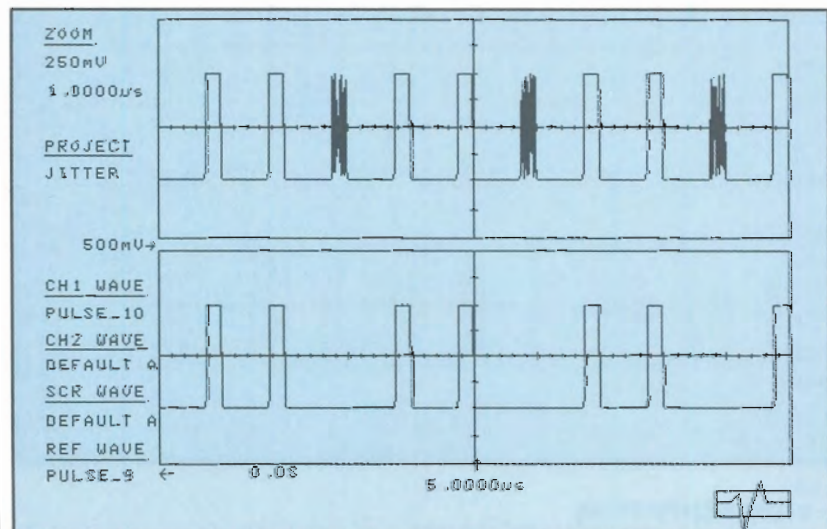

Figure 16. Modifying selected pulses within a pulse train



## Generating Bit Jitter Tolerance Tests

Arbitrary waveform generators (AWG's) are ideal sources of pulse waveforms for testing self clocked data communications and magnetic media storage systems. Unlike conventional pulse generators, selected pulses within a long pulse train can be modified to simulate a variety of conditions. Pulse amplitude, duration, transition time, or placement can be changed with great precision. The LeCroy LW400 Series AWG's, which include the ability to change waveform timing with 100 ps precision, are ideally suited for simulating bit jitter for testing clock recovery and data synchronizing circuits.

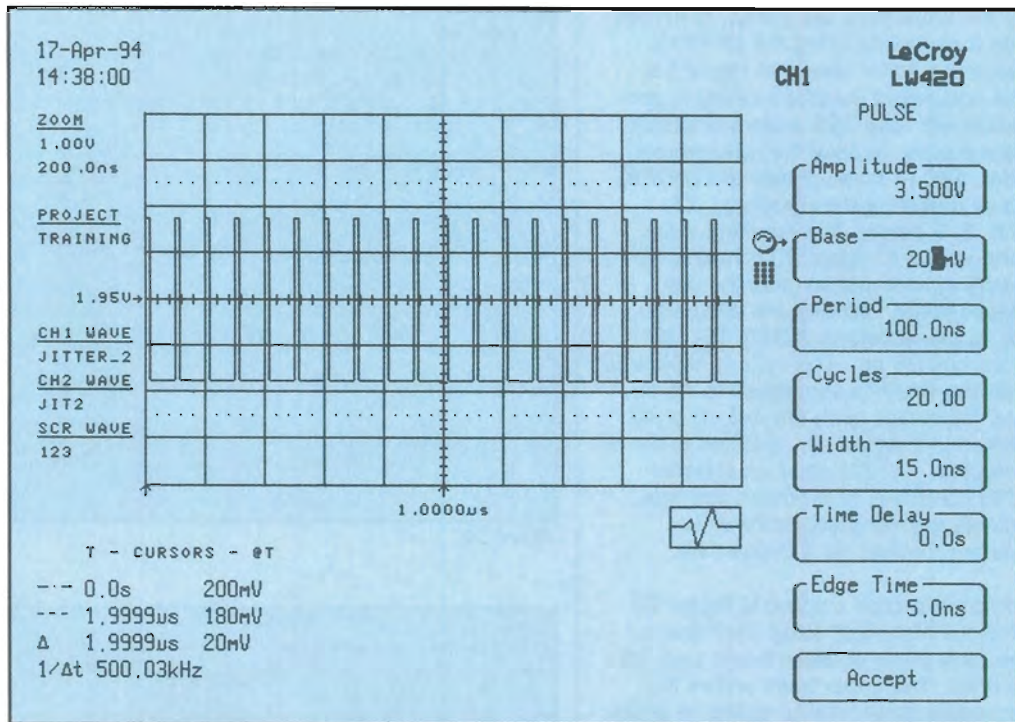

Figure 17.

A static window truncation test for disk drives, which determines the limits of the timing synchronization window, is a typical test of this type. The test uses a simulated encoded read data stream consisting of a long synchronization field of about 200 bits, with a single, move-

able bit at its end. The bit is initially located well outside the synchronization window and is gradually moved toward the nominal window center until it is reliably detected. The process is then repeated with the

moveable bit starting on the opposite side of the window. Figure 17 shows part of the synchronization field, made up of 20, 15 ns wide pulses with a 100 ns period, created using the standard pulse function in an LW 420 dual channel AWG. This waveform, repeated 9 times, will have another waveform, with the moveable bit, linked to it.

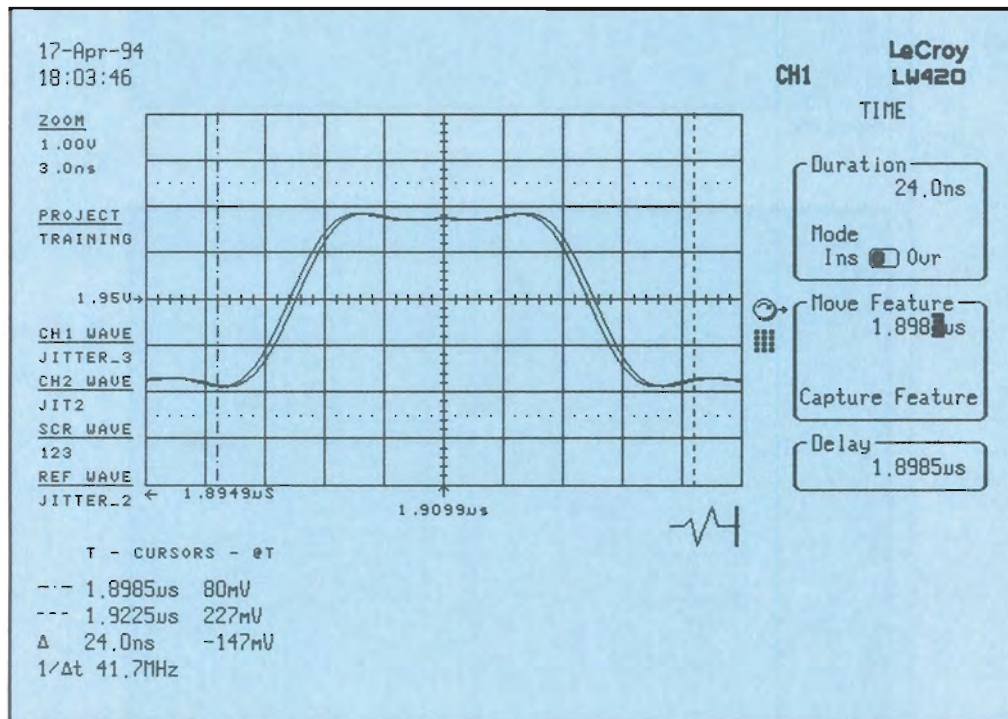

Figure 18.

The moveable bit is created at the end of a separate waveform, also containing 20 bits. The final bit in the waveform is moved in time by using the LW420's Move Feature capability which has 100 ps time placement resolution (see Figure 18). This pulse was advanced in time by 300 ps so that it is easier to see the displacement relative to the overlaid reference waveform. For this test, a series of these final waveforms, each containing a final bit with the displacement varied in 1ns steps, is created.



All the waveforms are joined, or linked, into a sequence using the LW420's sequence editor shown in Figure 19. The compound waveform which is generated will have 199 uniformly spaced data pulses, to allow for synchronization. 180 of these pulses are generated by repeating the waveform, JITTER\_2, 9 times. The resulting waveform shown in Figure 20 contains 19 evenly spaced pulses plus the displaced pulse. Initially, the moveable bit, in the waveform JITTER\_25, is advanced 25 ns. The cycle is repeated, with the advance decreased to 24 ns and continues, with the moveable bit shifted in 1 ns steps, until the pulse is detected. At this point an external GPIB controller, or a human operator, selects a second sequence which repeats the test for a delayed bit.

The oscilloscope display, in Figure 20, shows a history of pulse positions for the early pulse displacements from 25 to 0 ns. The upper trace shows the moveable pulse relative to the neighboring fixed pulses. The lower trace is a horizontal expansion of the upper trace showing the uniformity of the time displacements over the 25 ns range.

The test described above used a 1ns time displacement increment. The LW 420 is capable of 100 ps displacements as shown in the oscilloscope display of Figure 21. The lower trace, a highly expanded view of the moveable pulse, shows the pulse with 0.5, 1, 1.3, 1.4, and 1.5 ns displacements from the initial rightmost trace.

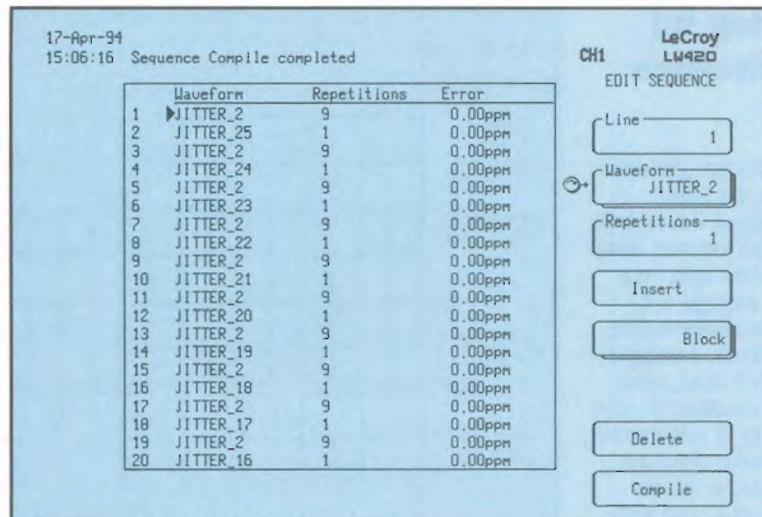

Figure 19.

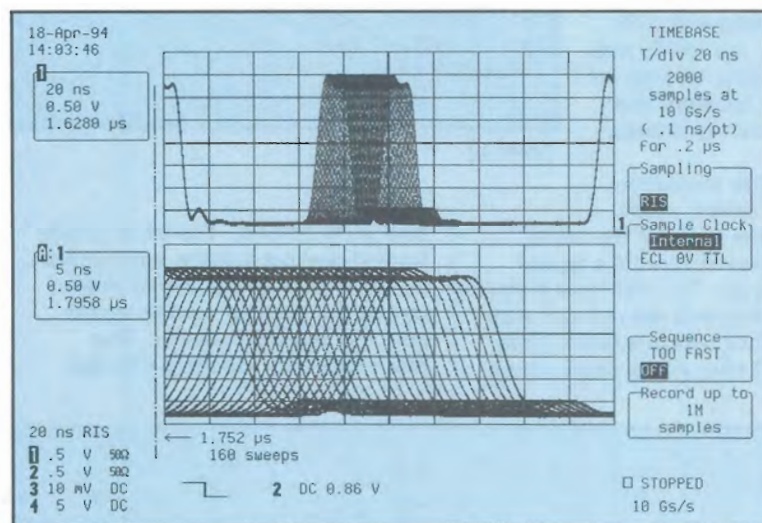

Figure 20.

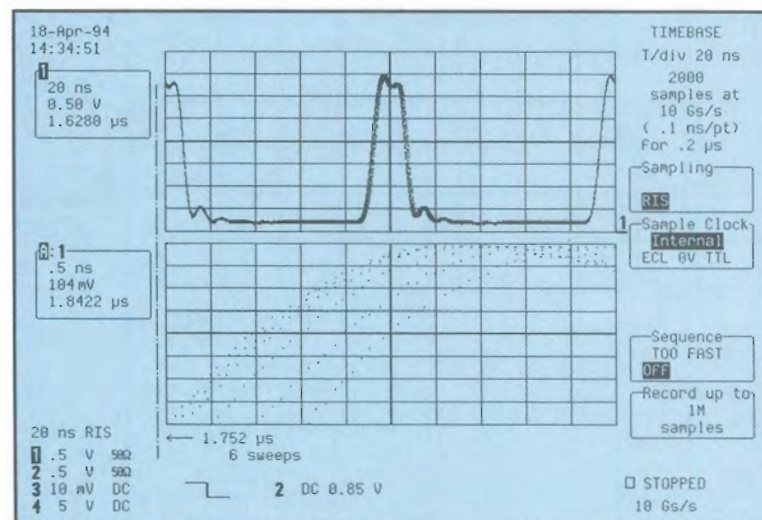

Figure 21.



## Creating Jitter to Specification

The LeCroy LW400 series arbitrary waveform generators (AWG's) are ideal signal sources for worst case timing tests in digital communications and magnetic data storage systems. Data and timing signals can be generated with precisely controlled amounts of jitter. Signal timing can be controlled, with 100 ps timing resolution, using the LW400's waveform modification feature. Figure 22 shows a single pulse being moved within a pulse train. Individual control of waveform duration and delay are also available, each can be applied to entire waveforms or to selected portions of a waveform as shown here.

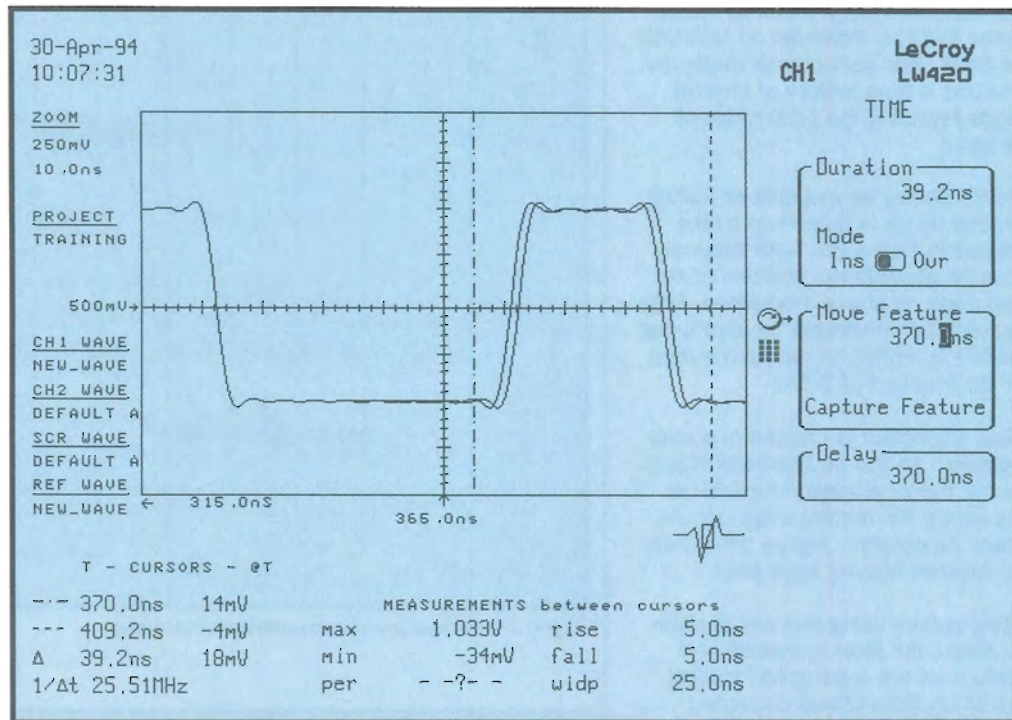

Figure 22. Modifying waveform timing using move

Jitter can also be described analytically, using equations. Creating jitter in this way allows the user to specify jitter as a function of time. Figure 23 shows the equations which describe a 10 MHz pulse train in which each pulse is displaced linearly with time. Both the leading and trailing edges move synchronously with a maximum time shift of 1/6 of a cycle (16.6 ns).

The equations in Figure 23 show the basic technique for creating a pulse train with jitter. Phase modulated sine and cosine waves are squared off using the step function and then multiplied to create periodic rectangular pulses. The phase modulation waveform, on line X1, controls the jitter waveform and magnitude. In this example the waveform is a simple ramp which produces a linear phase shift of  $\pi/3$  radian over a period of 10 msec.

(continued on next page)

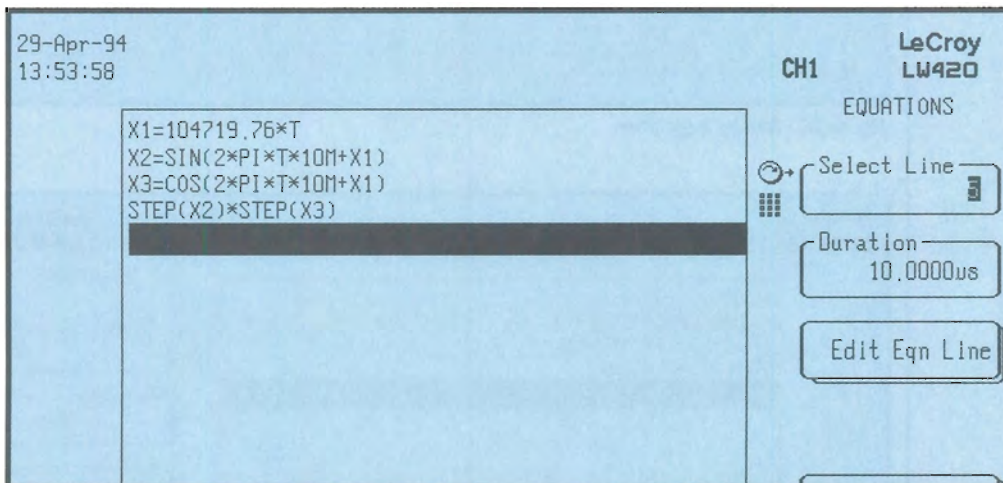

Figure 23. Equations for creating jitter

Figure 24 shows the measured output from the AWG as displayed on a LeCroy 9354 DSO. The persistence mode display shows a time history of several seconds revealing the total range of pulse jitter.

Figure 25 shows an example of trailing edge jitter which is described by the equations in Figure 26. Note that only the cosine controls the position of the trailing edge, is phase modulated. Edge placement for waveforms created using equations is limited to the AWG's minimum clock period of 2.5ns

Leading edge jitter is created in a similar fashion. As the equations in Figure 27 show, the sine wave, which determines where the leading edge occurs, is phase modulated. Figure 28 shows the measured leading edge jitter.

Creating pulses using this set of equations allows the jitter waveform and magnitude of the leading and trailing edges to be defined and controlled independently.

Figure 29 shows a simple version of this, by inverting the phase modulation of the cosine wave, edges move in opposing directions. The resultant pulse width jitter is shown in Figure 30.

Any of the LW400 waveform functions can be used to control the jitter waveform. In this example a simple linear ramp was used but sinusoidal, exponential, logarithmic and random (NOISE or GNOISE) functions can be used to describe the variation of pulse edge position as a function of time. Using the LW400 series AWG's jitter creation under the total control of the user, from live, interactive waveform manipulation to precise analytic descriptions.

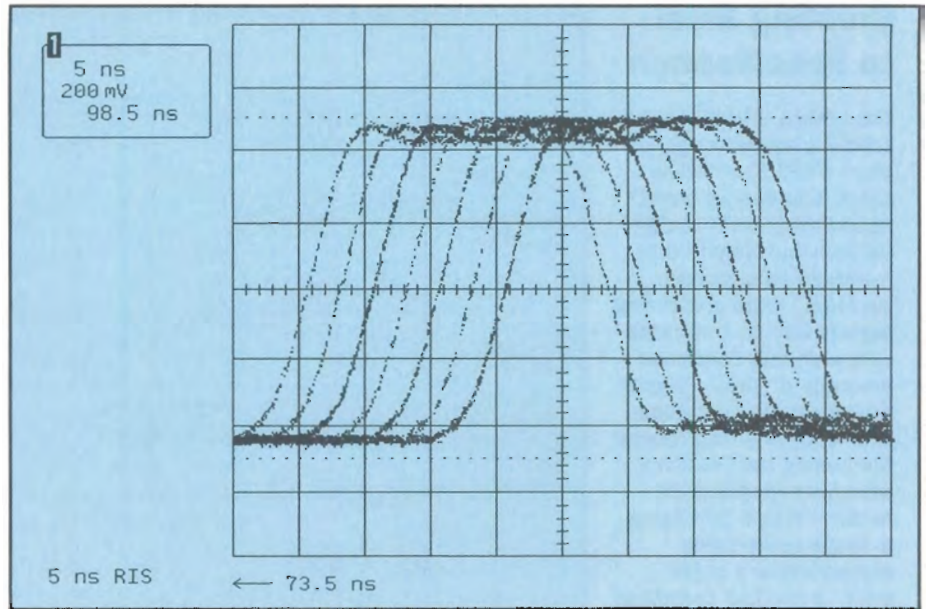

Figure 24. Persistence display showing jitter range

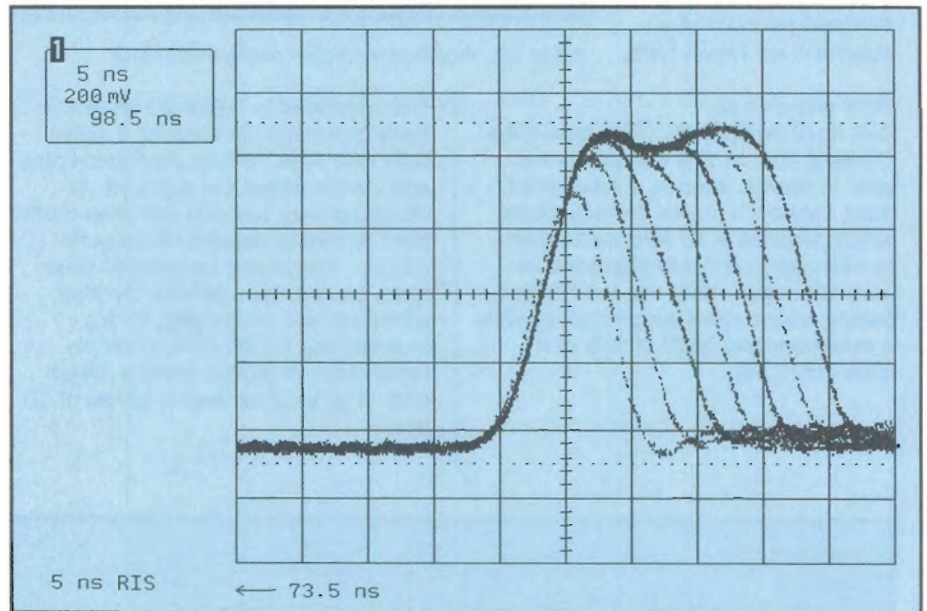

Figure 25. Trailing edge jitter

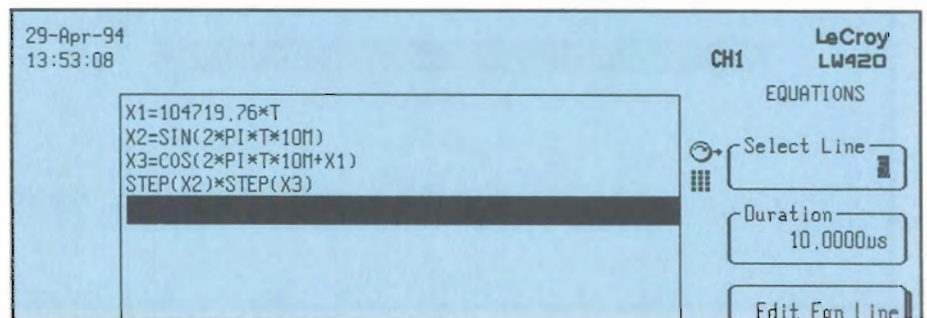

Figure 26. Equations for trailing edge jitter



29-Apr-94  
13:54:32

CH1 LeCroy  
LW420

EQUATIONS

```

X1=104719.76*T
X2=SIN(2*PI*T*10M+X1)
X3=COS(2*PI*T*10M)
STEP(X2)*STEP(X3)
    
```

Select Line

Duration  
10.0000us

Figure 27. Equations for leading edge jitter

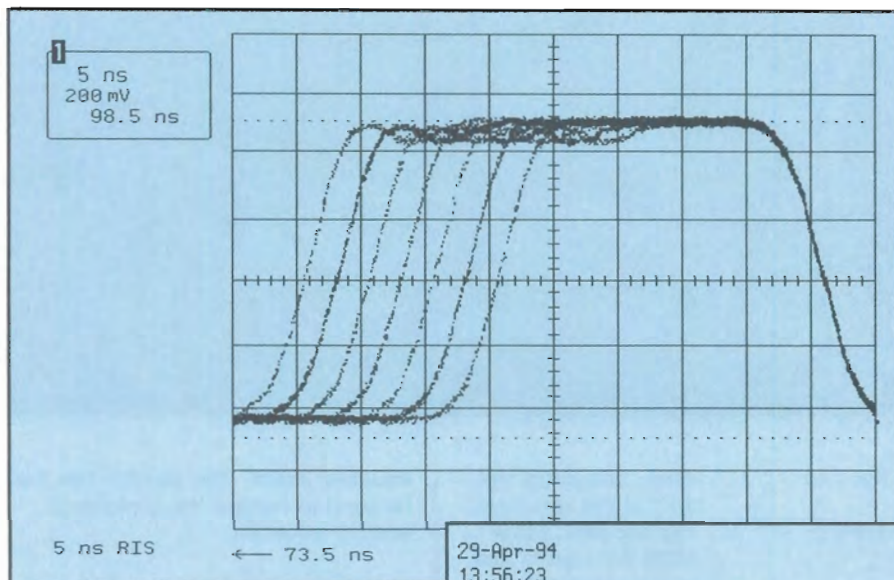

Figure 28. Leading edge jitter

29-Apr-94  
13:56:23

CH1 LeCroy  
LW420

EQUATIONS

```

X1=104719.76*T
X2=SIN(2*PI*T*10M+X1)
X3=COS(2*PI*T*10M-X1)
STEP(X2)*STEP(X3)
    
```

Select Line

Duration  
10.0000us

Figure 29. Equations for Opposing edge jitter

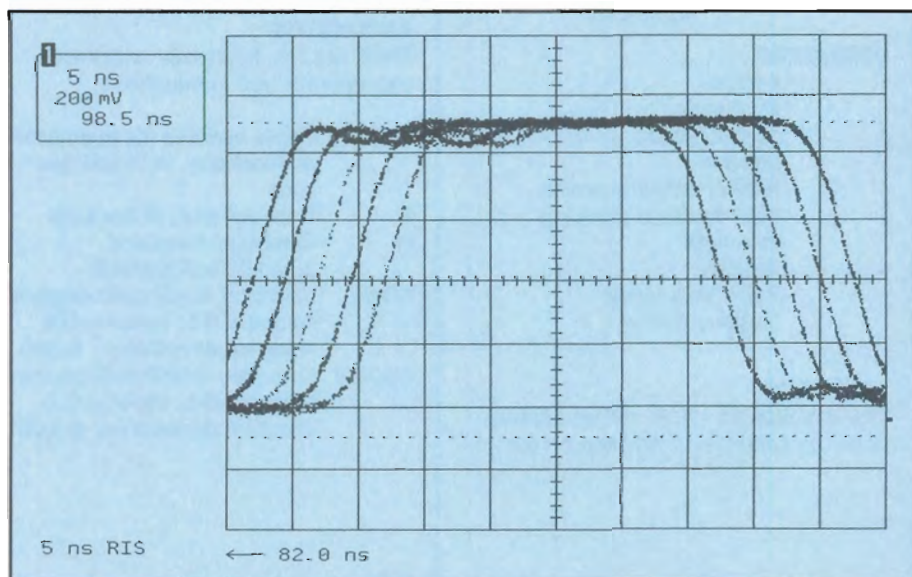

Figure 30. Edges moving in opposite directions

## LW400 Equation Notebook

Equations offer the most precise method of creating a waveform in the LeCroy WaveStation, LW400 Series Arbitrary Waveform Generator. This notebook is intended to provide examples of commonly used waveforms and the equations which describe them. It also provides examples of waveform creation techniques which can be applied more generally.

The WaveStation equation editor includes 11 mathematical functions and 9 operators, which are described briefly below. A more thorough discussion, of each, can be found in the LW400 Operators Manual:

### FUNCTIONS

ABS ( )	-Absolute value, calculates the absolute value, unipolar magnitude, of a function or argument
COS ( )	-Cosine, calculates the cosine of the argument
EXP ( )	-Exponential, calculates an exponential, using the base of natural logarithms, e, raised to the power specified in the argument
FLOOR ( )	-Floor, calculates the integer floor of a function
LN ( )	-Natural Logarithm, calculates the natural logarithm, base e, of the argument or function
LOG ( )	-Common Logarithm, calculates the common logarithm, base 10, of the argument or function
PULSE ( )	-Pulse, creates a pulse using edge locations, or functions, specified in the argument

SIN ( )	-Sine, calculates the sine of the argument
SQRT ( )	-Square root, calculates the square root of the argument or function
STEP ( )	-Step Function, creates a unit step at the location specified by the argument or function
TAN ( )	-Tangent, calculates the tangent of the argument

### OPERATORS

+	- Addition
-	- Subtraction
*	- Multiplication
/	- Division
(	- Mathematical grouping
)	- Mathematical grouping
'	- comment
=	- equality
^	- Raise to a power (exponentiation)

### VARIABLES

The variables X1 - X16 can be used to label the contents of any line on the

equation editor. The variable can then be used to replace the contents in another equation.

Example:  
 $X1 = \text{SIN}(2 * \text{PI} * 10\text{E}6 * T)$   
 $X2 = (1 + 0.75 * \text{COS}(2 * \text{PI} * 1\text{E}3 * T))$   
 $X1 * X2$

The product  $X1 * X2$  will be computed as follows:

$X1 * X2 = \text{SIN}(2 * \text{PI} * 10\text{E}6 * T) * (1 + 0.75 * \text{COS}(2 * \text{PI} * 1\text{E}3 * T))$

### ARGUMENTS

There are five functional arguments available for use in equations:

$2 * \text{PI} * T$	Phase variable for trigonometric functions, in radian seconds
T	Time variable, in seconds
PI	Numerical Constant 3.14159265358979
NOISE	Uniformly distributed random numbers 0-1, mean = 0.5 standard deviation = 0.288
GNOISE	Gaussian distributed random numbers 0-1, mean = 0.5 standard deviation = 0.1667

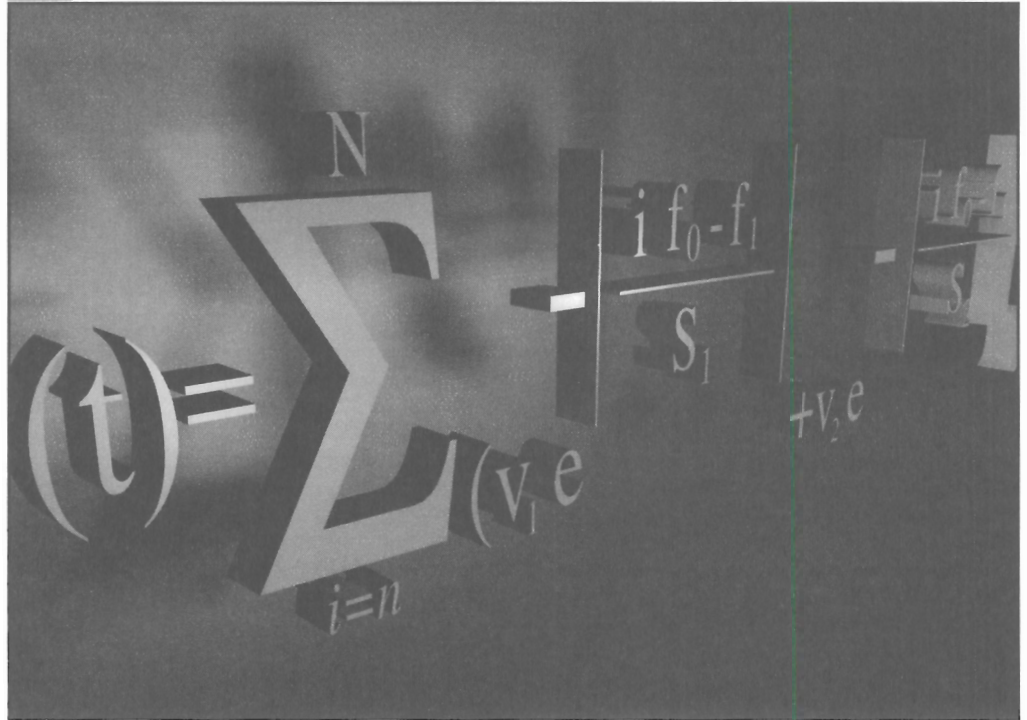



## CONSTANTS

Numerical constants can be entered from the keypad on the front panel. Use the units multiplier entry keys, p(pico, 1E-12), n ( nano, 1E-9), u (micro, 1E-6), m (milli, 1E-3), ENTER (units, 1), k (kilo, 1E3), M (Mega, 1E6) to specify the correct multiplier. For example 7.5 M = 7.5 E6 and 2n = 2 E-9

## EQUATION FILES

Equations can be created offline in a text editor and imported as equation files, specified by the file extension, .EQN. Consult the operators manual for specific information on the format of equation files.

## WAVE MATH

Equations are used in the creation of waveforms from an analytical description. Wave Math is a waveform array processor which operates on entire waveforms, regardless of their source. The operations available in wave math include:

- Smoothing
- Waveform Addition
- Waveform Subtraction
- Waveform Multiplication
- Waveform Division
- Integration
- Differentiation
- Convolution

These operations are available in addition to equation entry but are unique in that they operate on entire waveform. Wave Math operations are covered in a separate publication.

## USING THE EQUATION NOTEBOOK

In the following examples each waveform type includes a general equation showing the functions, arguments, and variables required. User entered constants are described in general terms. The accompanying waveform includes a specific numerical example. It provides the actual equation used to create the waveform shown.

**Waveform****1. Unit Step****General Equation**

STEP ( $T-T_0$ )

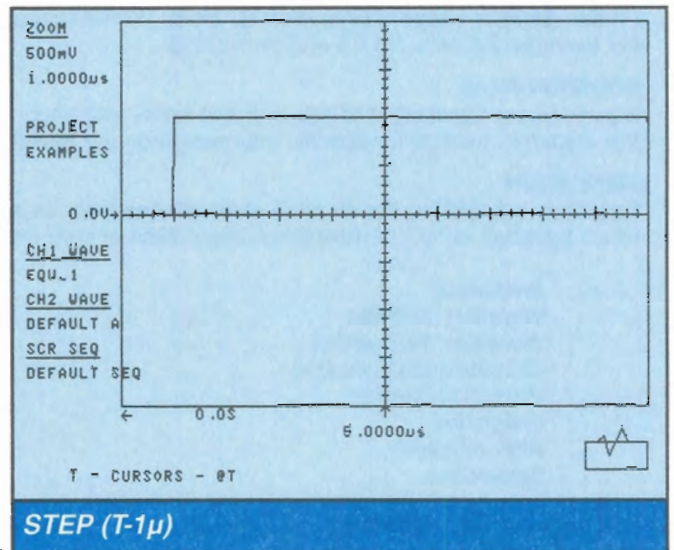
 $T_0$  - Edge location  
in seconds**LW420 Example****2. Time Reversed Step (Step Down)**

STEP ( $T_0-T$ )

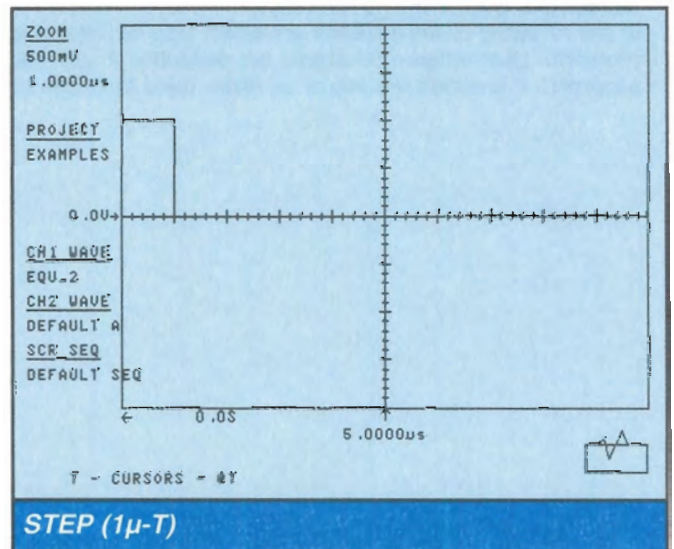
 $T_0$  - Edge location  
in seconds**3. Unit Pulse**

PULSE ( $T_1, T_2$ ) or  
STEP ( $T-T_1$ ) - STEP ( $T-T_2$ )

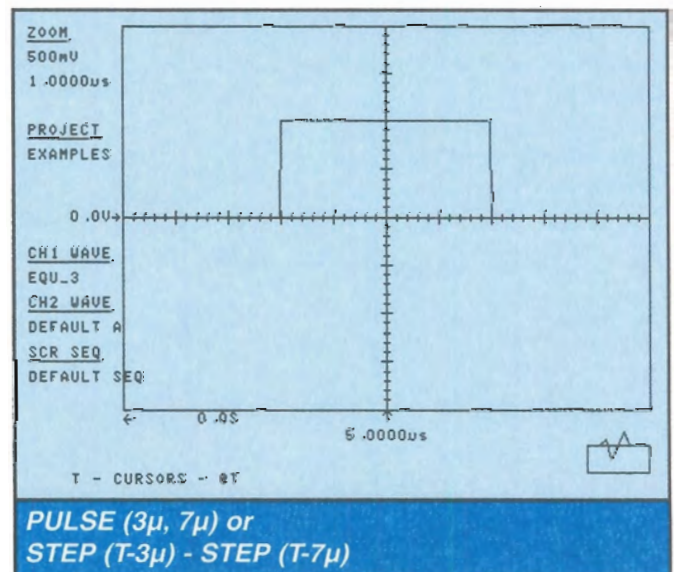
 $T_1$  - Time of leading edge  
in seconds $T_2$  - Time of trailing edge  
in seconds



## Waveform

## General Equation

## LW420 Example

### 4. Pulse Train

$$\text{STEP}(\text{SIN}(2 * \text{PI} * \text{T} * \text{F}_S))$$

$F_S$  - Pulse frequency  
in Hertz

Note: The LW420 function STEP ( ) accepts other functions, f(t), as an argument:  
 $\text{STEP}(f(t) \geq 0) = 1$   
 $\text{STEP}(f(t) < 0) = 0$

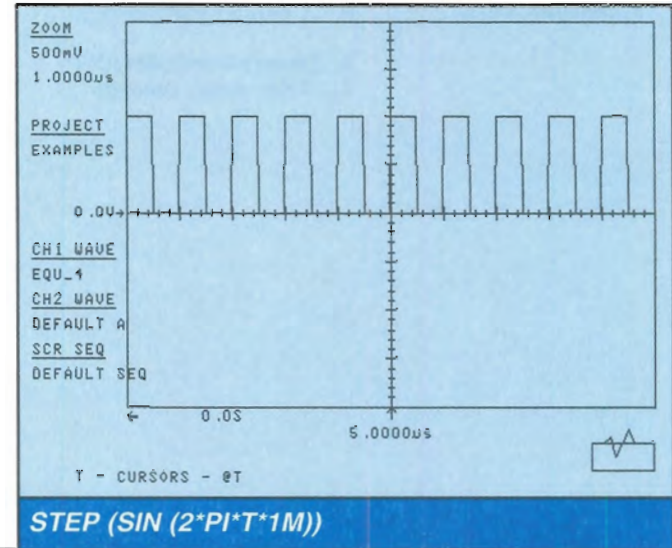

### 5. Tri-level Pulse

$$\text{PULSE}(T_1, T_2) - \text{PULSE}(T_3, T_4)$$

$T_1, T_3$  - Time of leading edges  
in seconds

$T_2, T_4$  - Time of trailing edges  
in seconds

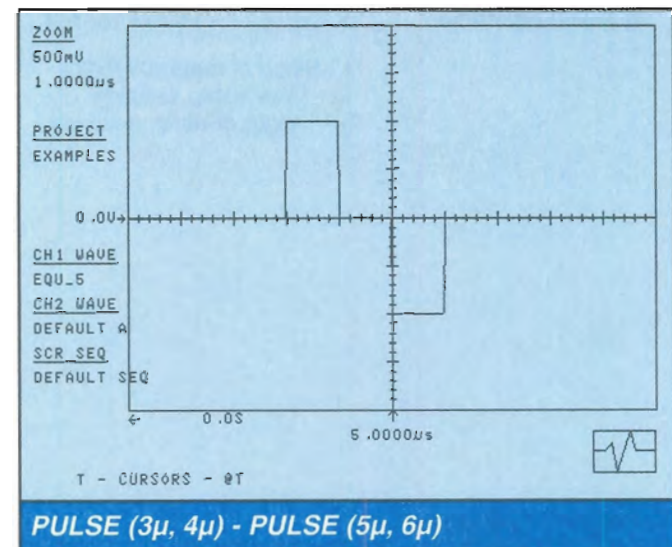

### 6. Ramp

$$A * T$$

A - Slope of ramp ( $\Delta V / \Delta T$ )

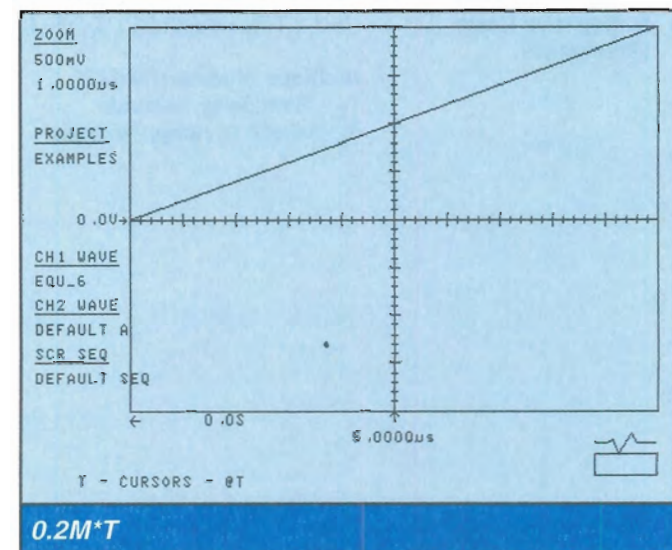

## Waveform

## General Equation

## 7. Delayed Ramp

$$A * (T - T_D) * \text{STEP}(T - T_D)$$

A - Slope of ramp (DV/DT)

$T_D$  - Time delay, seconds

## LW420 Example

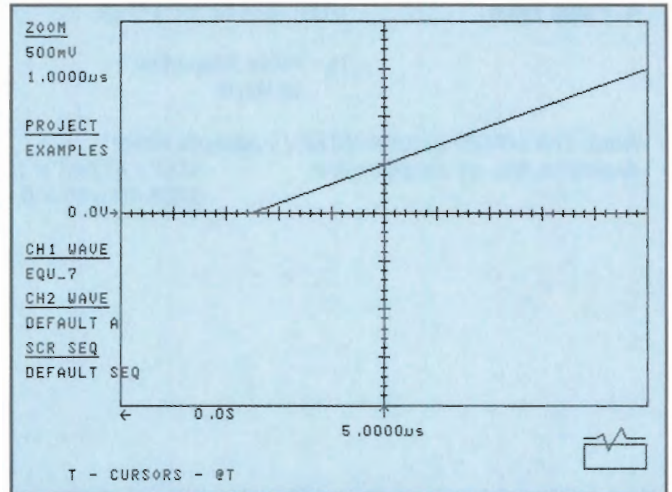

$$0.2M * (T - 2.5\mu) * \text{STEP}(T - 2.5\mu)$$

## 8. Truncated Ramp

$$A * (T - T_D) * \text{PULSE}(T_D, T_L)$$

A - Slope of ramp (DV/DT)

$T_D$  - Time delay, seconds

$T_L$  - Length of ramp, seconds

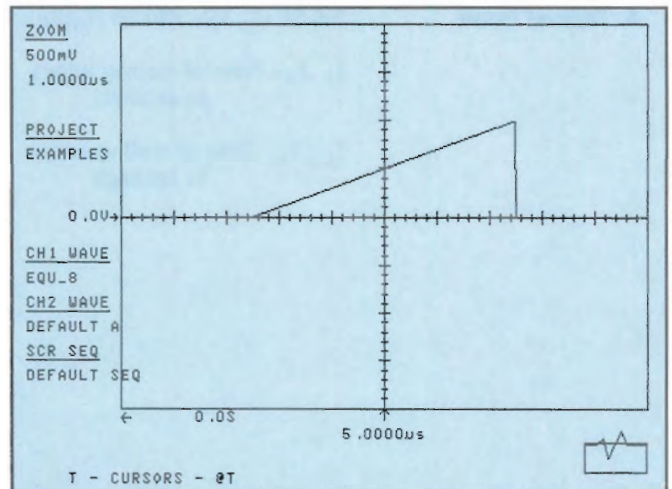

$$0.2M * (T - 2.5\mu) * \text{PULSE}(2.5\mu, 7.5\mu)$$

## 9. Negative Ramp (Truncated)

$$-A * (T - T_D) * \text{PULSE}(T_D, T_L)$$

A - Slope of ramp (DV/DT)

$T_D$  - Time delay, seconds

$T_L$  - Length of ramp, seconds

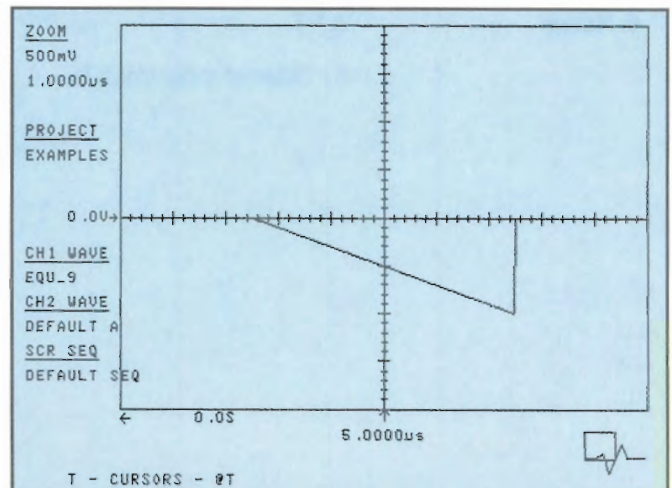

$$-0.2M * (T - 2.5\mu) * \text{PULSE}(2.5\mu, 7.5\mu)$$



## Waveform

## General Equation

### 10. Trapezoidal Pulse (with adjustable rise and fall times)

$$\begin{aligned} X1 &= -A * (T-T_1) * \text{STEP}(T-T_1) \\ X2 &= A * (T-T_2) * \text{STEP}(T-T_2) \\ X3 &= A * (T-T_3) * \text{STEP}(T-T_3) \\ X4 &= -A * (T-T_4) * \text{STEP}(T-T_4) \end{aligned}$$

A - Edge slope (DV/DT)  
 T<sub>1</sub> - Leading edge start time  
 T<sub>2</sub> - Leading edge end time  
 T<sub>3</sub> - Trailing edge start time  
 T<sub>4</sub> - Trailing edge end time  
 all times in seconds

## LW420 Example

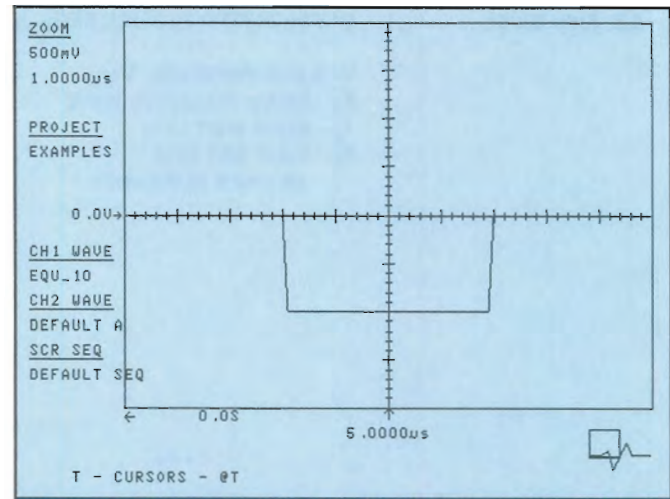

$$\begin{aligned} X1 &= -10M * (T-3\mu) * \text{STEP}(T-3\mu) \\ X2 &= 10M * (T-3.1\mu) * \text{STEP}(T-3.1\mu) \\ X3 &= 10M * (T-6.9\mu) * \text{STEP}(T-6.9\mu) \\ X4 &= -10M * (T-7\mu) * \text{STEP}(T-7\mu) \\ X1+X2+X3+X4 \end{aligned}$$

### 11. Sine

$$V * \text{SIN}(2*PI*T*F_S)$$

F<sub>S</sub> - Signal frequency, Hertz  
 V - Signal amplitude, V<sub>P-P</sub>

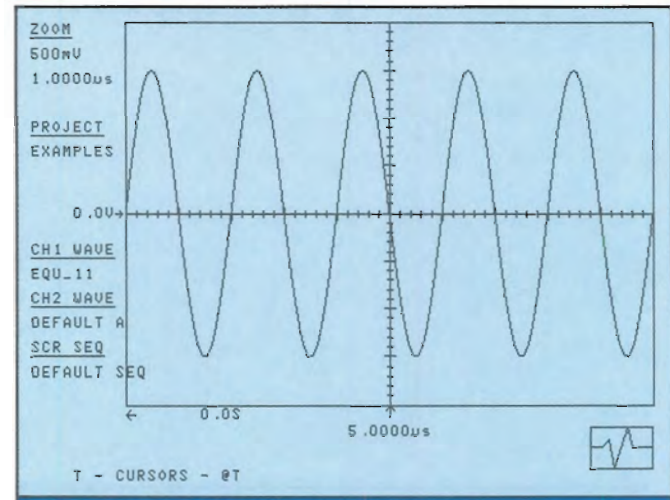

$$1.5 * \text{SIN}(2 * PI * T * 0.5M)$$

### 12. Gated Sine

$$V * \text{SIN}(2*PI*T*F_S) * \text{STEP}(T-T_G)$$

F<sub>S</sub> - Signal frequency, Hertz  
 V - Signal amplitude, V<sub>P-P</sub>  
 T<sub>G</sub> - Gate start time, seconds

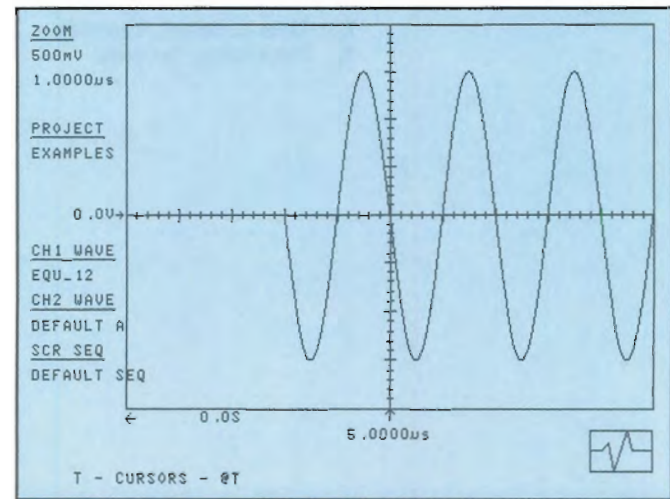

$$1.5 * \text{SIN}(2 * PI * T * 0.5M) * \text{STEP}(T-3\mu)$$

## Waveform

## 13. Sine Burst

## General Equation

$$V * \sin(2 * \pi * T * F_S) * \text{PULSE}(T_S, T_E)$$

V - Signal amplitude,  $V_{pp}$   
 $F_S$  - Signal frequency, Hertz  
 $T_S$  - Burst start time  
 $T_E$  - Burst end time  
 all times in seconds

## LW420 Example

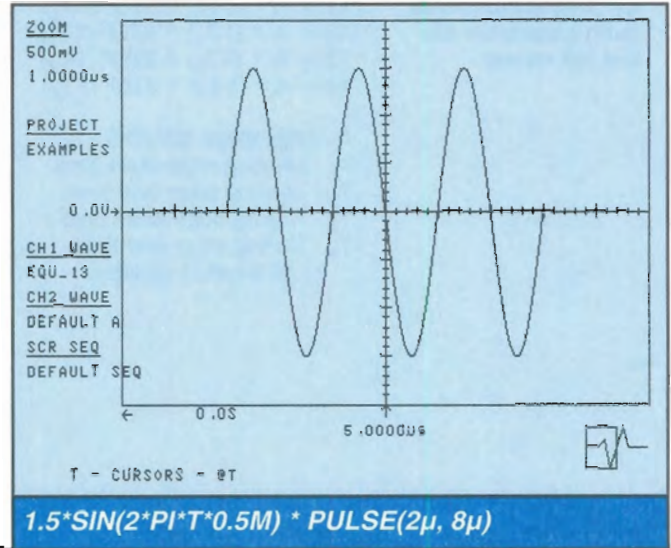

## 14. Decaying Exponential

$$\text{EXP}(-T / T_C)$$

$T_C$  - Time constant, seconds

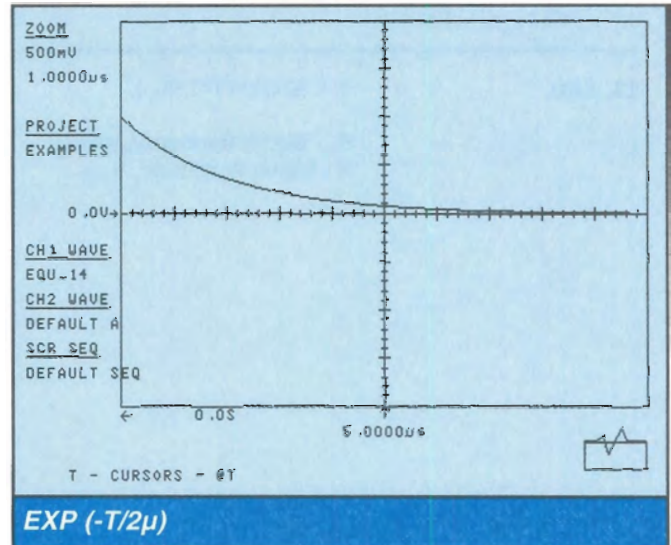

## 15. Delayed Exponential Decay

$$\text{EXP}(-(T - T_D) / T_C) * \text{STEP}(T - T_D)$$

$T_C$  - Time constant, seconds  
 $T_D$  - Time delay, seconds

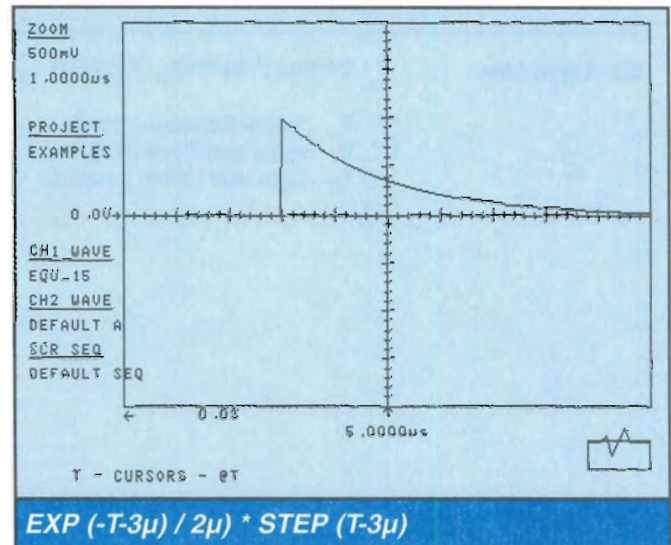



## Waveform

## General Equation

## LW420 Example

### 16. Rising Exponential

$$1 - \text{EXP}(-T / T_C)$$

$T_C$  - Time constant, seconds

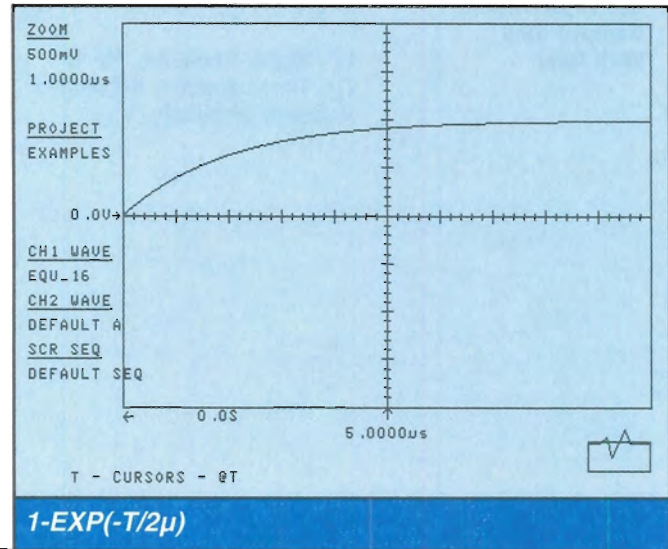

### 17. Delayed Rising Exponential

$$1 - \text{EXP}(-(T - T_D) / T_C) * \text{STEP}(T - T_D)$$

$T_C$  - Time constant, seconds  
 $T_D$  - Time delay, seconds

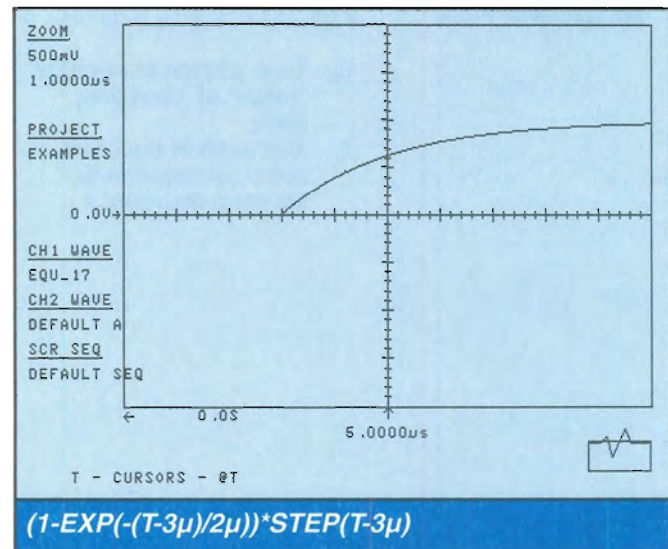

### 18. Exponential Pulse With Different Rise And Fall Constants

$$X1 = (1 - \text{EXP}(-(T - T_1) / T_2)) * \text{PULSE}(T_1, T_3)$$

$$X2 = (\text{EXP}(-(T - T_3) / T_4)) * \text{STEP}(T - T_3)$$

$$X1 + X2$$

$T_1$  - Delay of rising edge  
 $T_2$  - Time constant of rise  
 $T_3$  - Delay of falling edge  
 $T_4$  - Time constant of fall  
 $\Delta T$  - Sample period

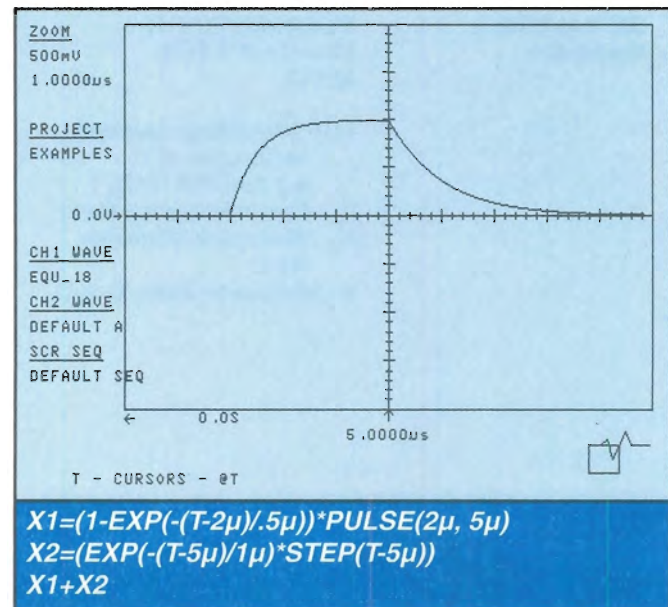

**Waveform****19. Exponentially Damped Sine With Gain****General Equation**

$$V * \exp(-T/T_C) * \sin(2 * \pi * T * F_S)$$

$F_S$  - Signal frequency, Hertz

$T_C$  - Time constant, seconds

$V$  - Signal amplitude,  $V_{p,p}$

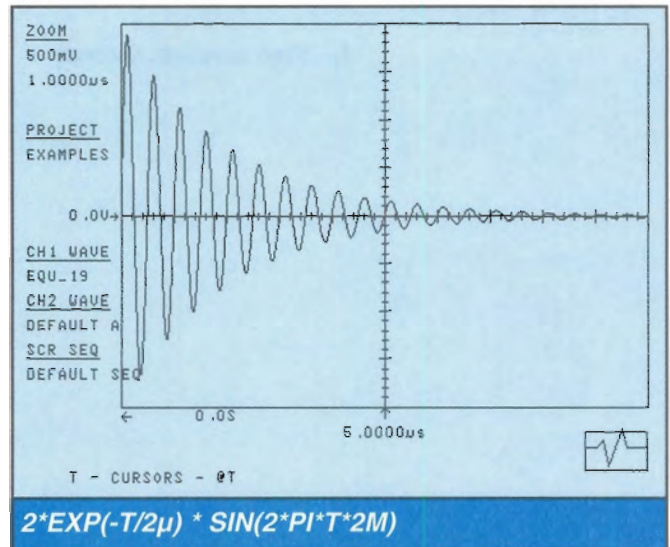
**LW420 Example****20. Gaussian Pulse**

$$\exp(-1/2 * ((T - T_M) / T_S)^2)$$

$T_M$  - Time location of center or "mean" of Gaussian pulse

$T_S$  - Half width of Gaussian point corresponds to standard deviation, s .

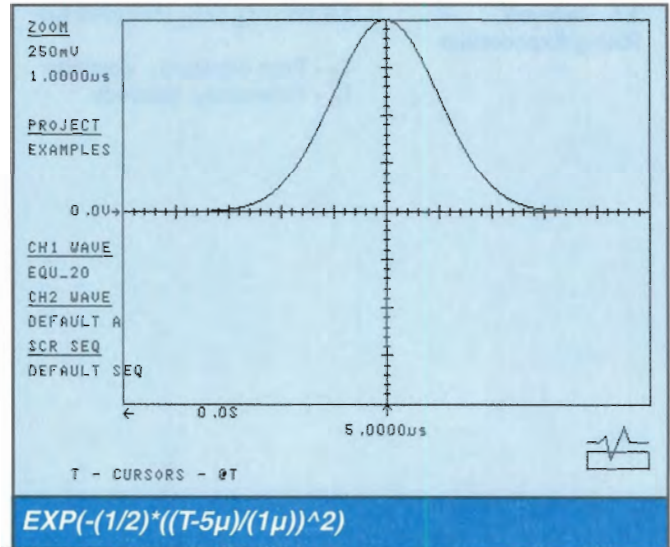
**21. Amplitude Modulation**

$$X1 = \sin(2 * \pi * T * F_C)$$

$$X2 = (1 + K * f(T))$$

$$X1 * X2$$

$f(T)$  - Modulating waveform, a function of  $T$ :

e.g  $\sin(2 * \pi * T * F_M)$

$F_C$  - Carrier frequency, Hertz

$F_M$  - Modulation frequency, Hertz

$K$  - Modulation index,  $0 < K < 1$

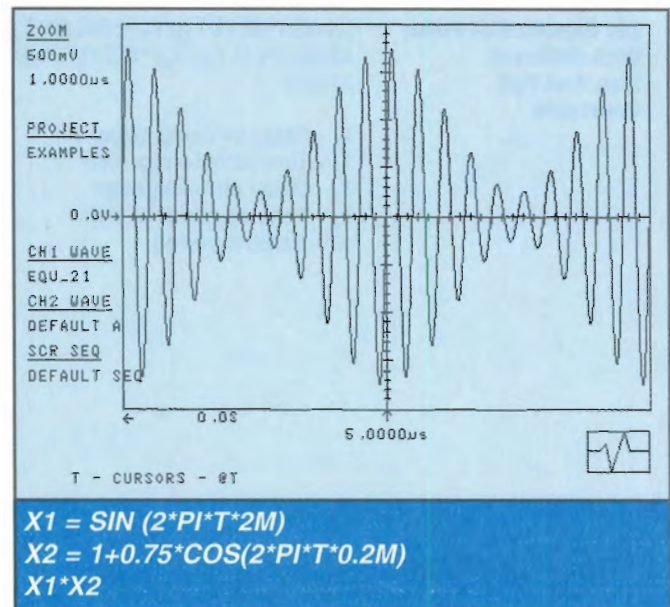



## Waveform

## General Equation

## LW420 Example

### 22. Sine Amplitude Sweep

$$(A*T) * \sin(2*PI*T*F_S)$$

A - Slope of ramp  
 F<sub>S</sub> - Signal frequency, Hertz

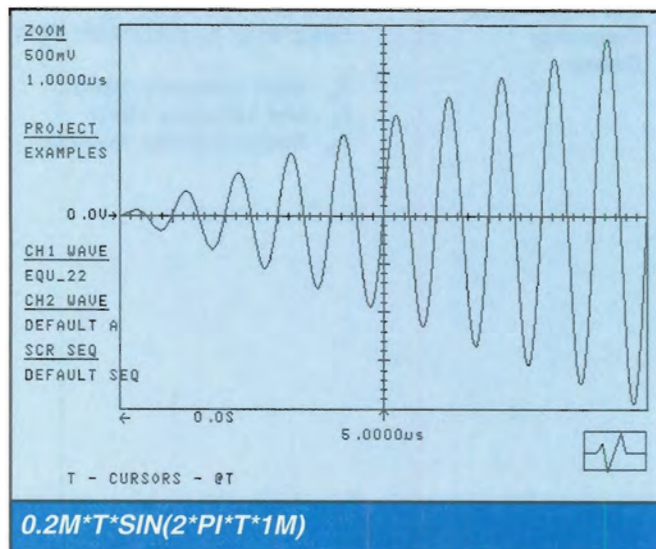

### 23. Frequency Modulation

$$\sin((2*PI*T*F_C + (F_D/F_M)*\cos(2*PI*T*F_M))$$

F<sub>C</sub> - Carrier Frequency, Hertz  
 F<sub>D</sub> - Frequency Deviation, Hertz  
 F<sub>M</sub> - Modulation Frequency

Note: For frequency modulation the phase argument of the SIN function includes the integral,  $\int f(t)$ , of the desired modulation function,  $f(t)$ : e.g. for sinusoidal FM  $f(t) = \sin(2*PI*F_M*T)$  the phase argument contains  $f(t) = \cos(2*PI*F_M*T)/(2*PI*F_M)$

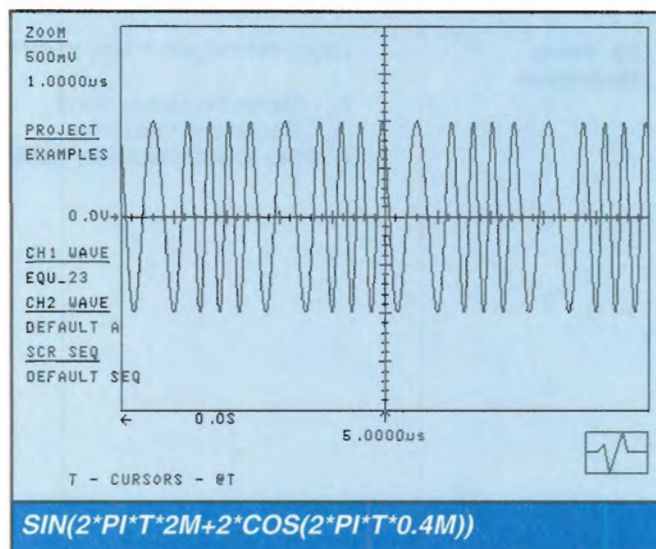

### 24. Linear Frequency Sweep

$$\sin(\pi*(2*T*F_S + ((F_E - F_S)/T_S)*T^2))$$

F<sub>S</sub> - Start frequency, Hertz  
 F<sub>E</sub> - End frequency, Hertz  
 T<sub>S</sub> - Sweep duration, seconds

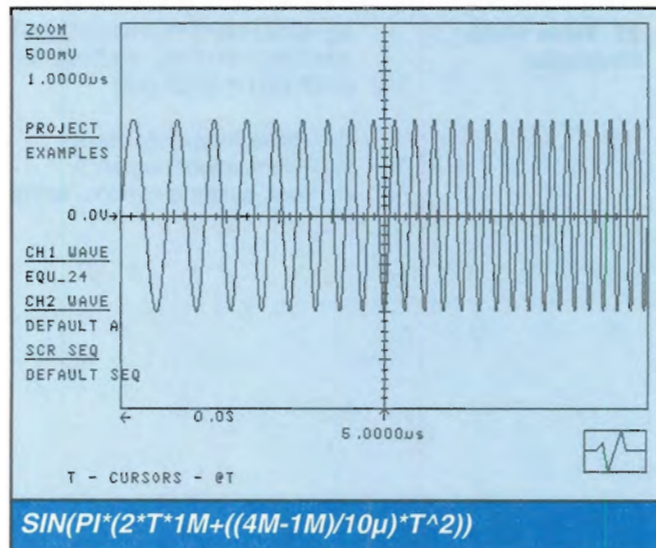

**Waveform****25. Logarithmic Frequency Sweep****General Equation**

$$X1 = \text{LN} ( F_E / F_S ) / T_S$$

$$\text{SIN}(2*\text{PI}*(( F_S / X1)*\text{EXP}( X1*T )-1)))$$

$F_S$  - Start frequency, Hertz  
 $F_E$  - End frequency, Hertz  
 $T_S$  - Sweep duration, seconds

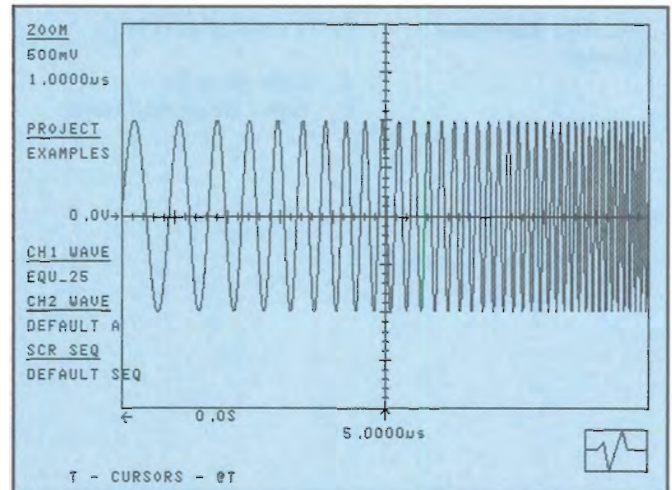
**LW420 Example**

$$X1 = \text{LN}(10\text{M}/1\text{M})/10\mu$$

$$\text{SIN}(2*\text{PI}*((1\text{M}/X1)*(\text{EXP}(X1*T)-1)))$$

**26. Phase Modulation**

$$\text{SIN}(2*\text{PI}*T*F_C + K * \text{SIN}( 2*\text{PI}*T*F_M ))$$

$F_C$  - Carrier frequency, Hertz  
 $F_M$  - Modulation frequency  
 $K$  - Peak phase excursion, radians

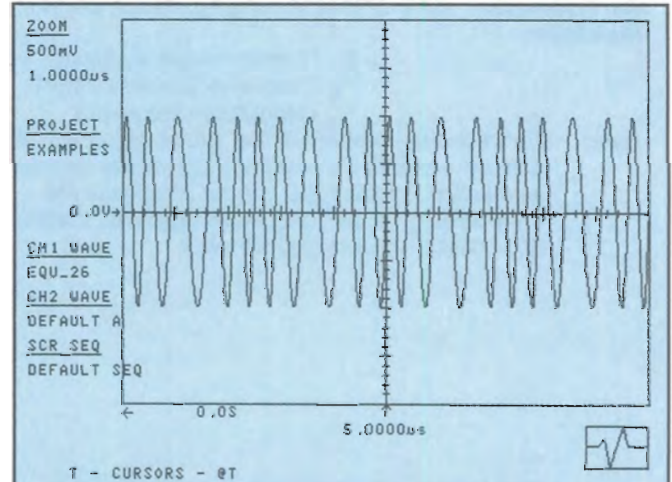

$$\text{SIN}(2*\text{PI}*T*2\text{M} + \text{PI}/2*\text{SIN}(2*\text{PI}*T*0.4\text{M}))$$

**27. Pulse Width Modulation**

$$X1 = \text{SIN}(2*\text{PI}*T*F_C + K*\text{COS}(2*\text{PI}*T*F_M))$$

$$X2 = \text{SIN}(2*\text{PI}*T*F_C + K*\text{SIN}(2*\text{PI}*T*F_M))$$

$$\text{STEP}(X1) * \text{STEP}(X2)$$

$F_C$  - Pulse frequency, Hertz  
 $F_M$  - Modulation frequency  
 $K$  - Peak phase excursion, radians

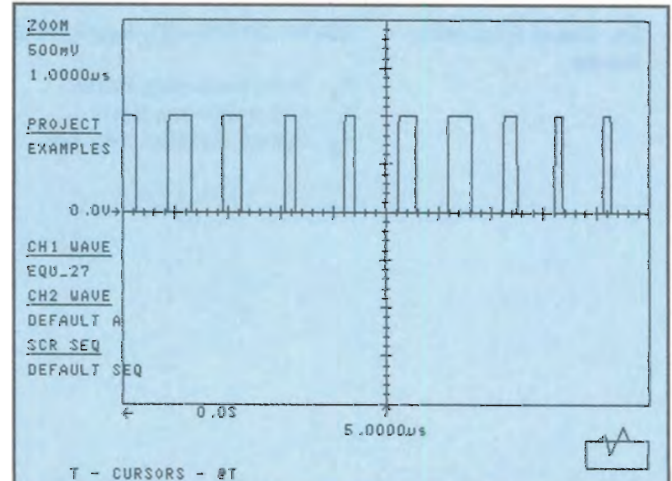

$$X1 = \text{SIN}(2*\text{PI}*T*1\text{M} + \text{PI}/2*\text{COS}(2*\text{PI}*T*.1\text{M}))$$

$$X2 = \text{SIN}(2*\text{PI}*T*1\text{M} + \text{PI}/2*\text{SIN}(2*\text{PI}*T*.1\text{M}))$$

$$\text{STEP}(X1)*\text{STEP}(X2)$$



## Waveform

### 28. Pulse Amplitude Modulation

### General Equation

$$A * T * \text{STEP}(\text{SIN}(2 * \text{PI} * T * F_C))$$

A - Slope of ramp, Volts/second  
 F<sub>C</sub> - Pulse frequency, Hertz

### LW420 Example

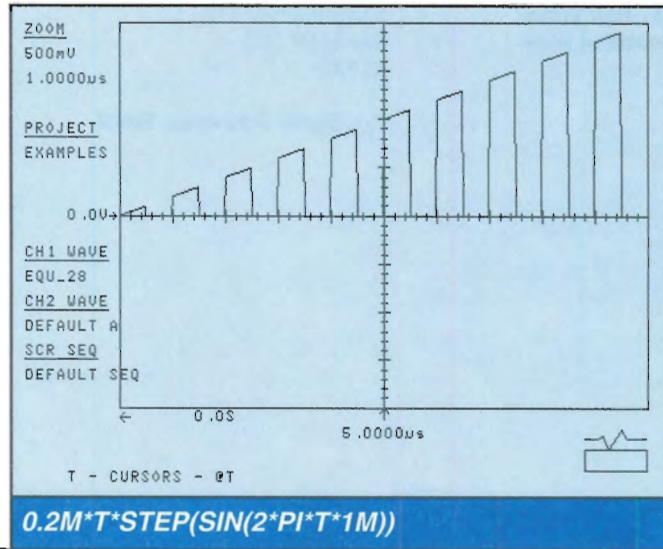

### 29. Lorentz Pulse

$$1 / (1 + ((T - T_D) / T_W)^2)$$

T<sub>D</sub> - Time delay, seconds  
 T<sub>W</sub> - Half width @ 50% amplitude, seconds

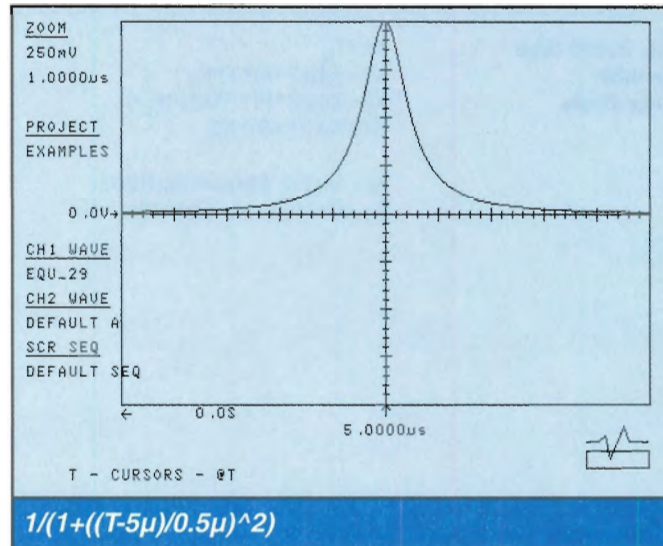

### 30. Full Wave Rectified Sine

$$\text{ABS}(\text{SIN}(2 * \text{PI} * T * F_S))$$

F<sub>S</sub> - Signal frequency, Hertz

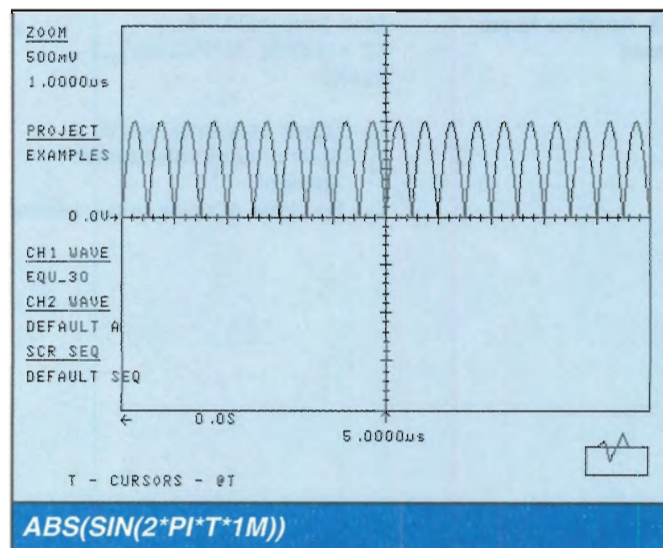

**Waveform****General Equation****LW420 Example****31. Half Wave Rectified Sine**

$$X1 = \sin(2\pi T F_S)$$

$$X2 = \text{STEP}(X1)$$

$$X1 * X2$$

$F_S$  - Signal frequency, Hertz

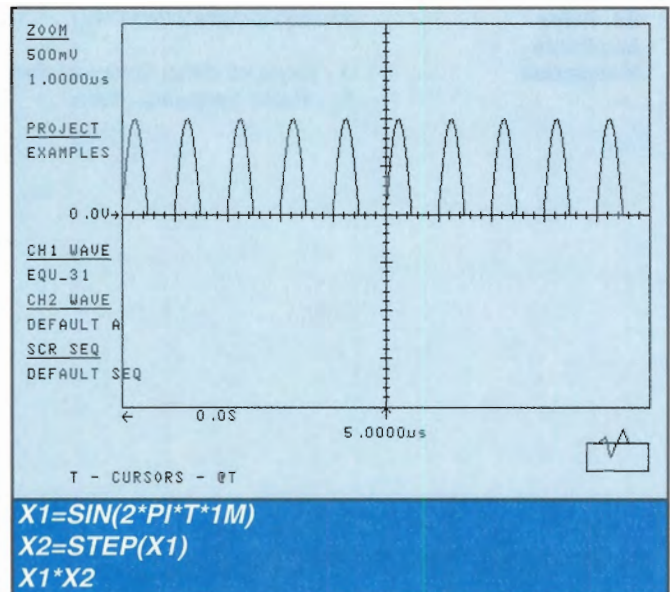
**32. Gated Sine Variable Duty Cycle**

$$X1 = T_D$$

$$X2 = \sin(2\pi T F_S)$$

$$X3 = \sin(2\pi (T - X1) F_S)$$

$$\text{STEP}(X2 * X3) * X2$$

$F_S$  - Signal frequency, Hertz  
 $T_D$  - Delay time, seconds

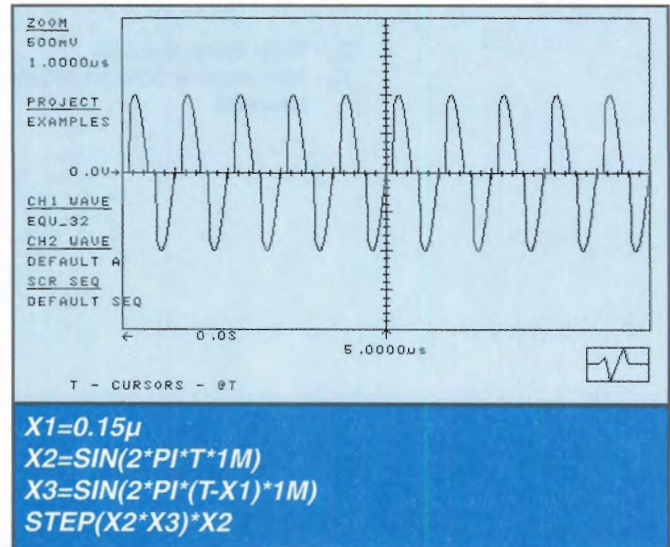
**33. Additive Noise Burst**

$$X1 = \sin(2\pi T F_S)$$

$$X2 = (\text{NOISE} \cdot 0.5) * \text{PULSE}(T_1, T_2)$$

$$X1 + X2$$

$F_S$  - Signal frequency, Hertz  
 $T_1$  - Start time of noise burst, seconds  
 $T_2$  - End time of noise burst, seconds

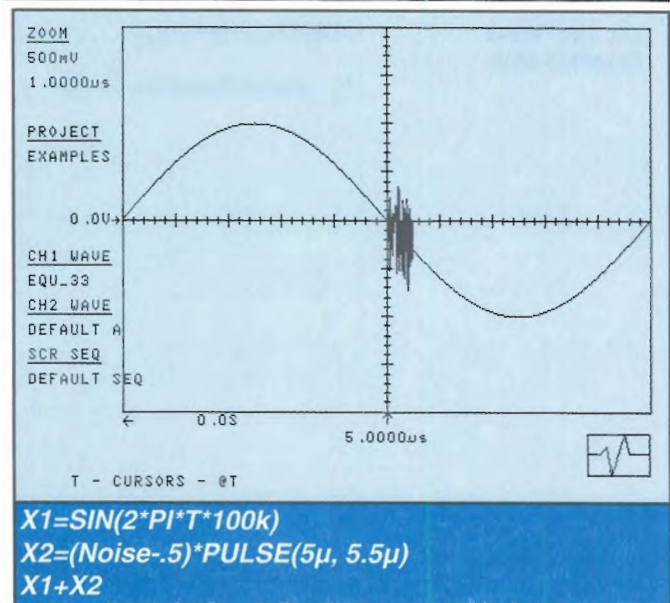



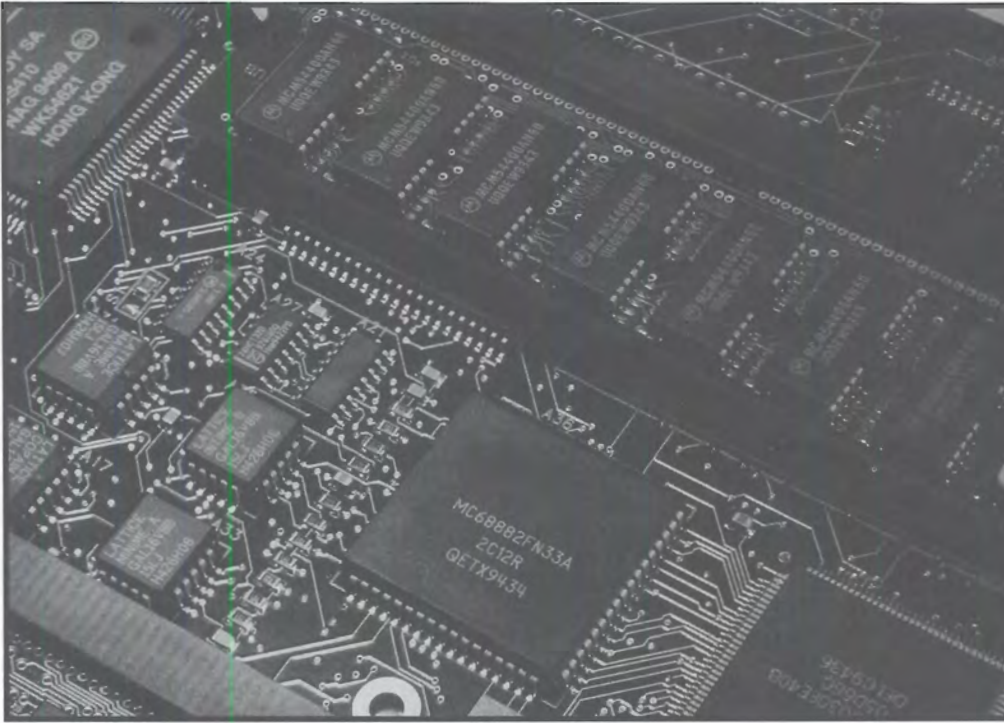

## Introduction

Analog designers have long battled against high-frequency effects such as reflections, noise, capacitive loading and power supply transients. They address these problems with tools like Transmission Line theory and Network Analysis. Until recently, digital designers have been unaffected by such "analog" phenomena. But today's hardware designer, analog or digital, ignores them at his or her peril.

With microprocessor clock speeds now routinely exceeding 50 MHz, and the corresponding reduction in transition times and propagation delays, digital circuits are exhibiting increasingly non-digital behavior.

The old simplifying assumptions (perfectly square pulses, clean edges, all signals either High or Low) are no longer valid. At the same time, fewer systems are 100% analog or digital; many are "mixed signal", imposing analog and digital design disciplines.

Fortunately, help is at hand. New design tools are better able to theoretically model such effects. At the same time, new Digital Storage Oscilloscopes provide the capability to investigate real-world performance. This Application Note introduces the different types of DSO available for high-speed work, and discusses their relative merits and applications.

## DSO Applications in High Speed Electronics

This technical note discusses the uses of digital oscilloscopes in capturing, viewing measuring, analyzing and documenting high speed electronic signals. Particular discussions include sample rate considerations, the effect of memory on sample rate, making measurements of **high speed signals in the presence of noise, crosstalk measurements, clock skew problems and metastability**. Examples are given of measuring the propagation delay through a fast semiconductor device (specifying maximum, minimum and average times) and of triggering on microprocessor crashes.



**SAMPLE RATE CONSIDERATIONS**

Most scope users realize that the bandwidth of the front end amplifier sets a limit on the ability to examine high speed signals. A DSO's sample rate also limits the fastest signal that it can capture. To avoid aliasing (which completely distorts displayed waveforms) the sample rate must be at least twice as fast as the highest frequencies present in the signal (Nyquist criterion). In order to make precise measurements, however, the sample rate should be approximately 10 times faster than the frequencies measured.

Sample rate is especially critical in digital design and debug applications, where unpredictable circuit behavior is often caused by fast glitches. Determining the cause of such glitches may require detailed analysis of their form and timing. This, in turn, needs the high resolution provided by fast sampling. Figures 1, 2 and 3 show the effect of sampling a 1 nanosecond glitch at 1, 2.5 and 5 GigaSamples per second.

Single-shot capture is particularly important when looking for intermittent faults, so a single-shot DSO should be used for debugging and troubleshooting new designs. The fastest single-shot DSO currently available is LeCroy's 10 GigaSample 9362.

Repetitive scopes may be used to troubleshoot an already characterized circuit, where the board under test will be compared with known good signal shapes. The parameters measured (e.g.

phase margins, timing values, etc.) are typically repetitive. LeCroy's 1 GHz 9324 is a low-cost repetitive DSO and is ideal for such applications.

A third category is the "general-purpose" DSO, which offers both high bandwidth and fast single-shot sampling. A good example is LeCroy's 9374, with 1 GHz bandwidth and 2 Gs/s single-shot digitizing. This family also offers the longest-memory DSOs currently available, with up to 8 MegaBytes of acquisition memory.

**LONGER MEMORY MEANS HIGHER EFFECTIVE BANDWIDTH**

Any DSO's maximum sample rate is just that - the fastest it can possibly sample. But at most timebases, DSOs sample far slower than maximum speed. This is because they must fill their acquisition memory in exactly the time specified by the timebase. So when you set the time per division, you are also specifying the sample rate. But the more memory a scope has, the faster it can sample during that time. So the longer your memory, the faster you can sample.

This is particularly important in debugging microprocessor based systems. Any circuits with asynchronous events are easier to debug with fast digitizing over long time windows. Figure 4 is a typical example. The top trace shows a burst of communication pulses between

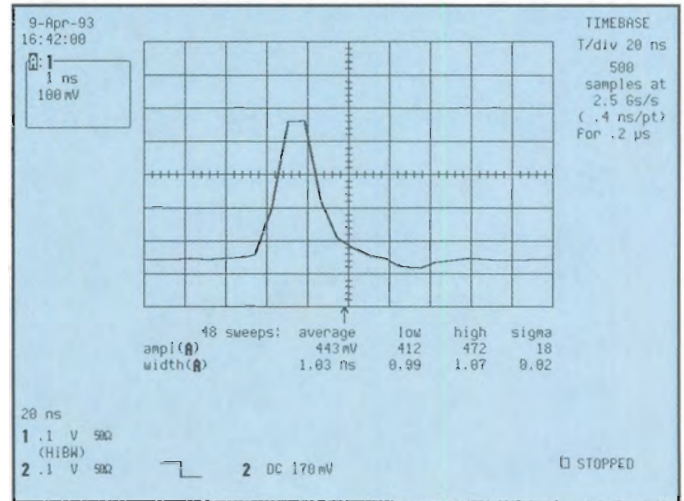

Figure 2. The glitch of figure 6 sampled at 2.5 GS/s. Width is measurable, but peak amplitude information is missing.

a microprocessor and a peripheral device. This was acquired at a relatively slow timebase, showing a complete 2 millisecond burst. The waveform has also been expanded (lower trace) in order to make measurements on the individual pulses. The 2 Megabyte memory of the 9374L or 9354L allows the signal to be acquired at 500 MS/s, even over the long time-window required.

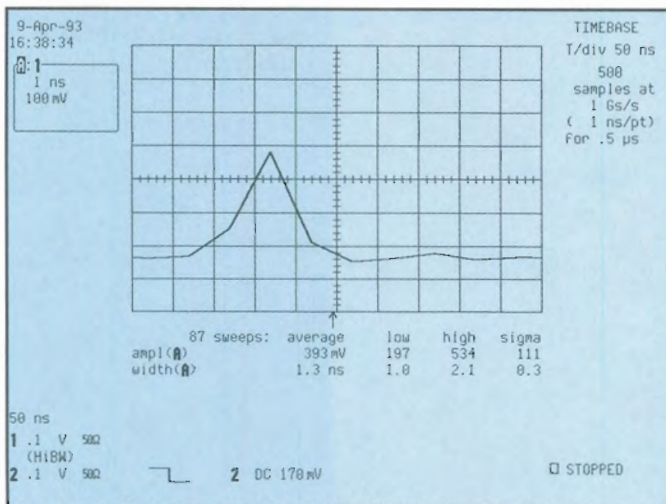

Figure 1. 1 ns glitch digitized at 1 GS/s. It is impossible to accurately determine amplitude or width.

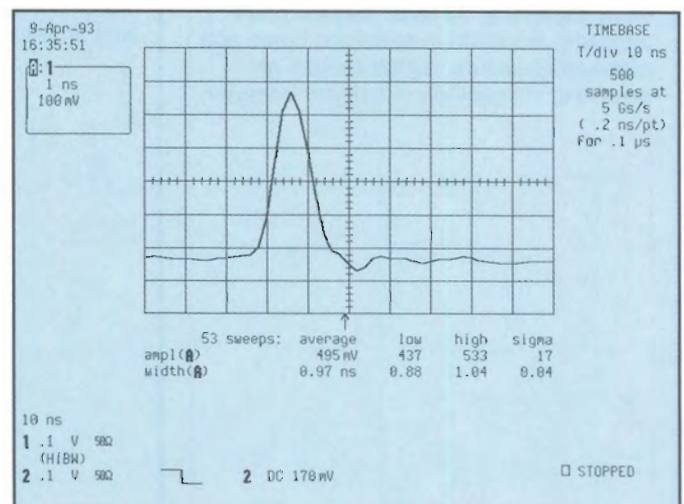

Figure 3. The same glitch sampled at 5 GS/s. Both pulse width and peak amplitude may be measured accurately.



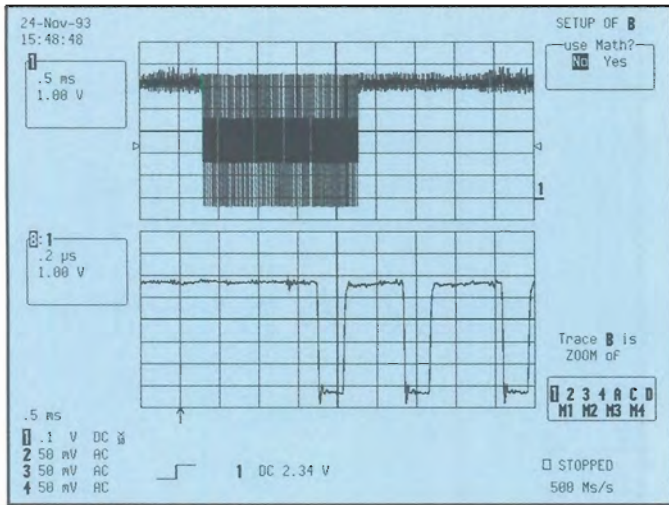

Figure 4. A burst of microprocessor communications activity. The expansion (lower trace) shows individual pulses in the train.

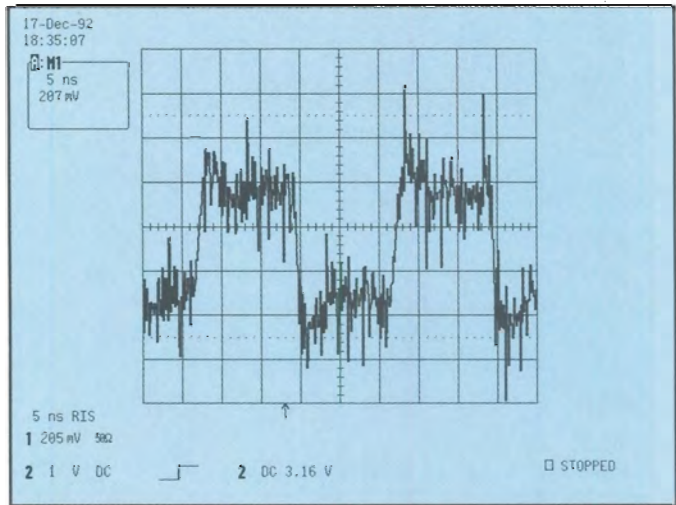

Figure 5. Noise removed by averaging.

## TYPICAL MEASUREMENT PROBLEMS

### MEASURING IN THE PRESENCE OF NOISE

It is sometimes necessary to characterize a circuit in noisy conditions. This may occur early in the product design, before shielding and layout issues are finalized. Alternatively, circuit layout may make good probe grounding difficult. In either case, the noise present can dramatically mask the measurement, as illustrated by Figure 5.

A common approach to the noise problem is to filter the signal. This, however, compromises measurement accuracy by reducing bandwidth. A better solution is to average the waveform over time. The noise, which is random, is averaged to zero. Thus, for example, LeCroy's Continuous Averaging function provides noise rejection without reducing the bandwidth. A further benefit of averaging is that the resulting averaged waveform has a greater dynamic range than the original waveform. This can be very useful when measuring small effects like overshoot on large signals. Figure 6 shows the effect of averaging the noisy waveform shown above.

### INTER-CHANNEL MEASUREMENTS

Most timing measurements are made between two or more different signals. For example, it may be necessary to test a BiCMOS buffer like the one specified in Figure 7.

The propagation delay (time from an input transition to an output transition) for this part is nominally 4.5 ns. The DSO (a LeCroy 9360 series scope) is

used to measure the time from CH1 (input) to CH2 (output). This delay is shown by the  $\Delta$ delay parameter (see Figure 8). In addition, statistics show the highest, lowest and average values, and the standard deviation. Alternatively, Pass/Fail testing could be used to verify that all acquisitions fall within the specified limits.

In the above example, timing is measured from the 50% point of the input edge to the 50% point of the output edge. This is typical for propagation delay measurements, although LeCroy DSOs allow the user to specify other signal

levels, either in percentages or in volts.

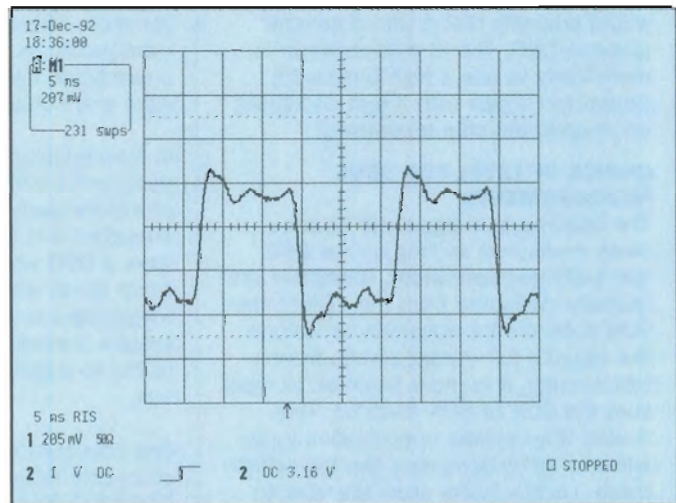

Figure 6. Noise removed by averaging.

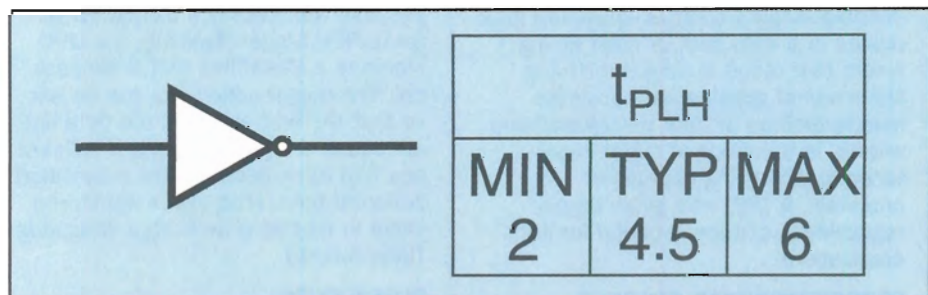

Figure 7. BiCMOS buffer, with typical specs for propagation delay (low to high transition).



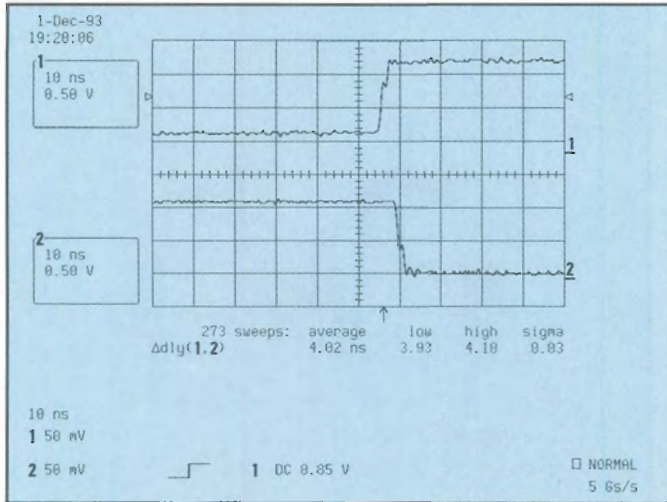

Figure 8. Propagation delay measurement.

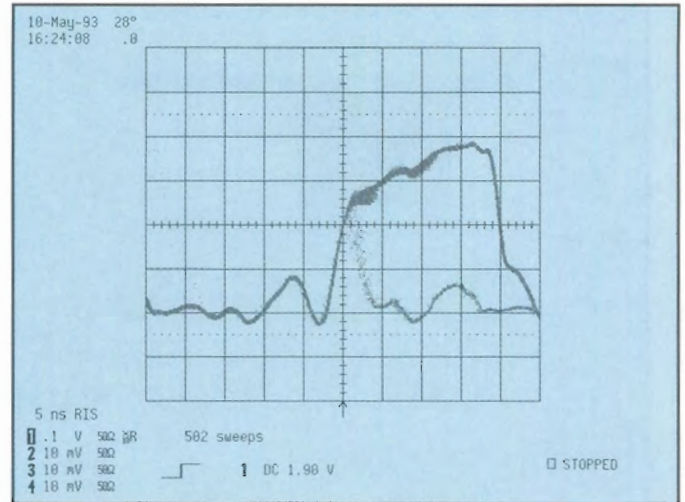

Figure 9. Flip-flop output exhibiting metastability.

An engineer using this buffer in a circuit would probably test it with a general purpose DSO. The IC manufacturer is more likely to use a high bandwidth (repetitive) scope with a test circuit set up to cycle the chip repetitively.

#### CHOICE OF LEVEL FOR EDGE MEASUREMENTS

The risetime of a signal will be accurately measured as long as the DSO has sufficient bandwidth. Risetimes are typically measured from the 10% to the 90% point on the waveform to include the signal's full voltage swing. In very fast circuits, it is more common to measure the 20% to 80% risetime. This makes the risetime specification insensitive to inflections near the top of the pulse. LeCroy DSOs allow the user to measure risetime at these or any other levels.

#### CROSSTALK

Parasitic capacitance between PCB tracks can cause the fast edges of high-speed logic to propagate from one signal line to another. This crosstalk can have catastrophic effects, producing glitches large enough to cross logic thresholds. Glitches may cause unpredictable failures such as unwanted logic pulses in a data path or even timing errors that result in device misfiring. Detection of glitches, and accurate measurements of their amplitudes and widths, is therefore of major importance in identifying sources of crosstalk. A DSO with glitch trigger capability is extremely useful for such applications.

#### MICROPROCESSOR CRASHES

During the final phase of many designs,

microprocessor crashes or lockups are common. These may be due to hardware problems, software bugs, or unpredicted interaction between hardware and software.

In investigating such crashes, the designer is interested in the sequence of events leading up to the failure. Therefore it is particularly helpful to have a DSO which can trigger on the crash itself, with a large amount of pre-trigger data stored in memory. If the system successfully restarts, it is also useful to trigger on the restart condition.

One convenient way to trigger on microprocessor lockup is LeCroy's unique DROPOUT trigger mode. Any busy processor line may be monitored, and a timeout period specified. Whenever the processor is quiet for longer than the timeout, the DSO will trigger. Using a 4-channel scope with long pre-trigger memory will allow several signals to be observed for milliseconds or even seconds before the crash.

Triggering on a successful restart is possible with LeCroy's unique EDGE QUALIFIED trigger. Typically, the DSO monitors a Reset line and a data signal. The trigger conditions can be set so that the first event on the data line will cause a trigger, but only if a Reset has first been asserted for a specified period of time. (The signal monitored might in fact be a dedicated Watchdog Timer output).

#### CLOCK SKEW

Timing problems may be caused by

skew between clock signals delivered to different parts of the circuit. It is therefore important to identify any skew or jitter present on clock edges. In order to measure accurately, the user must first eliminate any skew due to the DSO and probes used, particularly if the probes are not identical. To do this with a LeCroy DSO, connect both probes to the same test point and set the DSO to its fastest timebase. If any inter-channel skew is seen, use the zoom function to create copies of the main traces, and the zoom position control to eliminate the skew.

Jitter measurements may be made by using the DSO in Infinite Persistence display mode. Any changes in the signal's performance will be "painted" onto the display, so that the total jitter on a clock edge may be viewed.

#### METASTABILITY

The data input to a flip-flop should be stable for a given period of time before and after the clock pulse. This period is known as the device's setup and hold time. If the data changes during the setup and hold time, the flip-flop's output may not change cleanly, but go to an intermediate level between high and low. While it remains in this indeterminate state, the signal is said to be metastable.

Figure 9 shows the output of such a flip-flop, with many successive acquisitions overlaid in Infinite Persistence display mode. A region of metastability is clearly visible during the 5 nanoseconds following the low-to-high transition.



## PROBES AND PROBING

The simple act of probing a high-frequency circuit can significantly alter its performance. The proper use of probes is therefore crucial. It is important to choose the right probe for each measurement and also to use good grounding technique. Ground leads should be kept as short as possible and, whenever possible, a spring clip ground pin should be used.

There are three factors which are important when selecting a probe: bandwidth, resistance and capacitance. The effects of low probe bandwidth are obvious: the composite oscilloscope/probe bandwidth is degraded.

Low impedance passive probes offer very high bandwidth (typically several GHz). They also feature very low capacitance. Due to their low impedance, however, (typically  $500\Omega$ ) they present a significant load to the circuit under test. This resistive loading results in loss of signal amplitude. This may be a problem when using TTL with  $1\text{ k}\Omega$  pull-up resistors, or CMOS which is not capable of sourcing the current required. It is usually not a problem when using ECL.

High impedance passive probes present much lower resistive loading, but add significant capacitance. This can be a major bandwidth degrading factor, resulting in signal distortion. For example, the capacitance of a  $10\text{ M}\Omega$  probe is typically around  $15\text{ pF}$ . This means that with a  $1\text{ k}\Omega$  source impedance, bandwidth degradation would limit risetime measurements to the order of  $33\text{ ns}$ . HiZ probes are generally restricted to applications where signal frequency is less than  $50\text{ MHz}$ .

A better approach is to use an active probe. These have bipolar or field-effect transistors in the probe tip which act as the input stage of a buffer amplifier. These active probes provide high bandwidth, high impedance and low capacitance but they are more expensive, and may be sensitive to damage due to overvoltage abuse.

For more details on probes and probing, request Application Note ITIO16B.





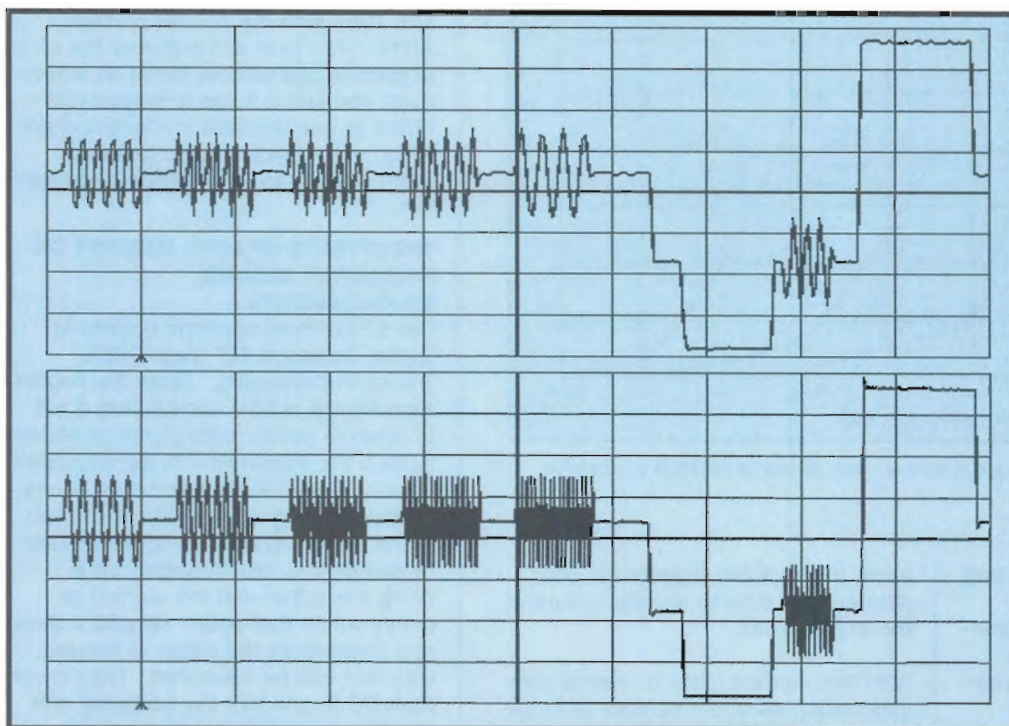

## Introduction

Two of the most important parameters to specify for a Digital Storage Oscilloscope are the length of its acquisition memory and the amount of RAM memory that can be applied to calculating answers from the raw data. The amount of acquisition memory in many cases determines the fidelity with which the scope can record a signal. But recording the signal is only the first step. The key to finding signal aberrations, characterizing circuit performance and making the wide variety of measurements that have made digital scopes popular is in the processing horsepower of the oscilloscope.

### CAPTURING A SIGNAL

The maximum time window that can be captured by a digital oscilloscope using a sampling period  $\Delta t$  is :

$$\text{Time Window} = \Delta t \times \frac{\text{Acquisition Memory Length}}{\text{Length}}$$

Where "Acquisition Memory Length" is the number of samples that can be captured in the data acquisition memory. Since the acquisition memory length is a fixed amount, the only way to capture longer time windows is to make the period between samples longer (see Figure 1). For example, a scope with 100k of memory and a sampling period of 2 nsec (500 MS/s) can capture a total time window of 0.2 msec at that sampling rate. If the user wanted to see a 4 msec signal using 100k samples, the points would have

to be stretched farther apart to 20 nsec per sample (25 MS/s). This means the accuracy of timing measurements is degraded by a factor of 20 and many signal details are lost. Any frequency above 12.5 MHz (one half the sample rate) will be aliased. Many DSO users believe the ADC in a scope determines its sampling rate. They don't realize the acquisition memory length also plays a vital role. The current state of the art for acquisition memory is 2 million sample points per channel. In the example just given, a full 4 msec can be captured at 2 nsec per sample using 2 million points. The bottom line is that a scope putting 2 million points on a signal will give you 40 times better timing accuracy, a much better view of your signal and more usable bandwidth than one which uses 100k points on the same signal.

### HOW TO USE LONG MEMORY TO SPOT SIGNAL IRREGULARITIES

One of the prime purposes of an oscilloscope is to troubleshoot problems. The toughest problems are ones which occur infrequently. Scope vendors have been working hard to help the engineer with this task. One recently introduced scope has a chip set that can quickly acquire many triggers and display a view of them in color persistence mode. Less frequent events come out in a different color than common events but few analysis tools are available. There is a further limitation that only 500 points can be acquired. This means the signal must have a short simple shape or that the sampling rate must be reduced to

## How to Use the Benefits of Long Memory in Digital Oscilloscopes

This technical note discusses how the user of a digital oscilloscope with long memory can apply that memory toward achieving higher sampling rate, spotting abnormalities in a signal and improving frequency domain measurements. In spotting signal irregularities, comparison is made to scopes which have a more limited ability to acquire 500 point waveforms in a fast view mode. Long memory allows a user to not only spot the signal irregularities with fewer triggers, it also provides the basis for making real measurements to troubleshoot the problem.

*The initial portion of this article was originally printed in EE Magazine, July 1995.*



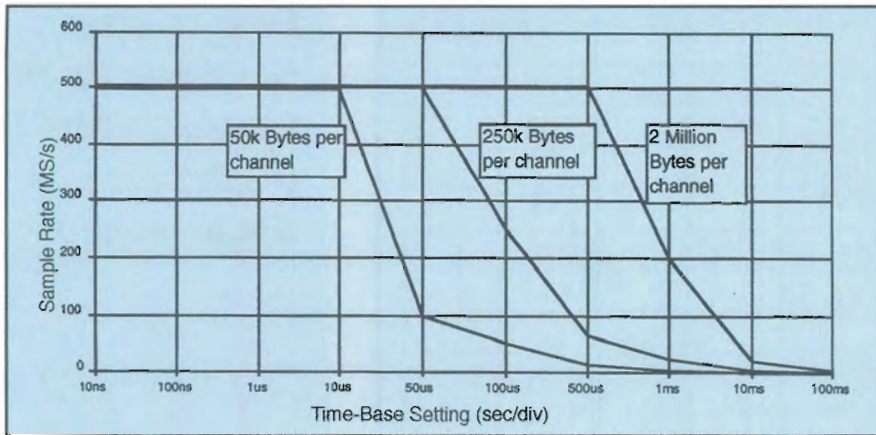

Figure 1. Maintaining the maximum sample rate over more timebase settings is possible with long memory.

record long events (with the danger that signal details and glitches will be missed between samples). Long memory can be used in a different way to attack this problem. Suppose the symptom is occasional misbehavior of a clock. The nature of the problem is unknown so there is no a priori knowledge that would allow the engineer to set up a special trigger (based amplitude, risetime, width, etc.). The user can simply use auto trigger, acquire 2 million samples of continuous clock data (per trigger) and then histogram the pulse amplitudes, widths, rise times, areas or other parameters of interest. A single trigger with 2 million data points will have as much information as 4,000 trigger of 500 points

each. In just a few triggers the user gets enough data to see the nature of the irregularities.

With this method there is measurable information as to the number of occurrences of each type of wrongly shaped clock pulse. Figure 3 shows what the results might look like if the clock synchronizer occasionally chopped a clock pulse. There are rare pulses which are very short followed by a second pulse with a glitch. The histogram of 993 sweeps quickly acquires 7046 pulses. The lowest width is 7.4 nsec, the average is 50 nsec and the high is 56.2. Note that the vertical scale is logarithmic. There are 12 bad clocks with 7.4 nsec width, 12 with 56.2 nsec width

and 7012 with the normal 50 nsec width. The user can measure the ratio of good to bad pulses, make an adjustment and see if it has a measurable effect or use the data in the histogram to set up a special trigger based on width in order to troubleshoot the problem.

### THE EFFECTS OF LONG MEMORY ON FREQUENCY DOMAIN MEASUREMENTS

One of the most common options in Digital Scopes is FFT (Fast Fourier Transform) capability. Since the Fourier transform in a DSO comes from a set of discrete points (with sampling period  $\Delta t$ ) the information in the frequency domain is also a discrete set of points (whose spacing is  $1/\Delta t$ ). The resolution in the frequency domain is determined by two factors, the frequency span being measured and the number of points within that span. Nyquist's theorem determines the range of frequencies that can be measured. They range from DC to one half the sampling rate at which the data was captured. A Fourier transform of an array of  $N$  time domain data points produces  $N/2$  frequency domain points within the range of frequencies between DC and the Nyquist frequency, so the frequency resolution of the FFT is

$$\Delta f = (1/2) \text{ Sampling Rate} \\ (1/2) \text{ Number of Points} \\ \text{input to the FFT algorithm}$$

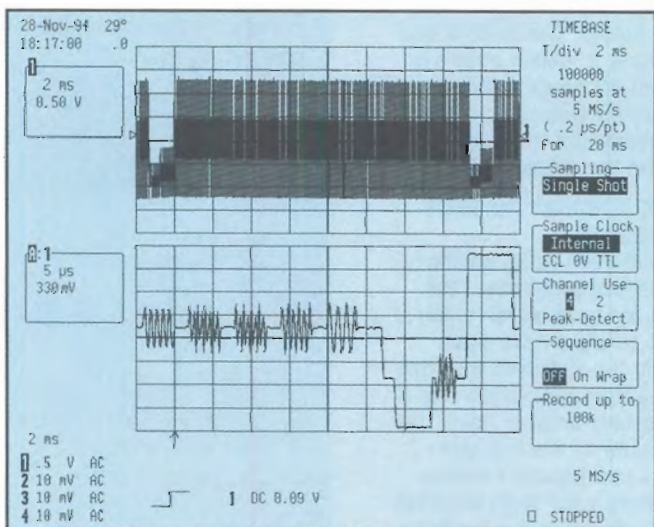

Figure 2a. Undersampled video waveform: 100,000 samples captured. The zoom trace reveals inaccurate aliased data.

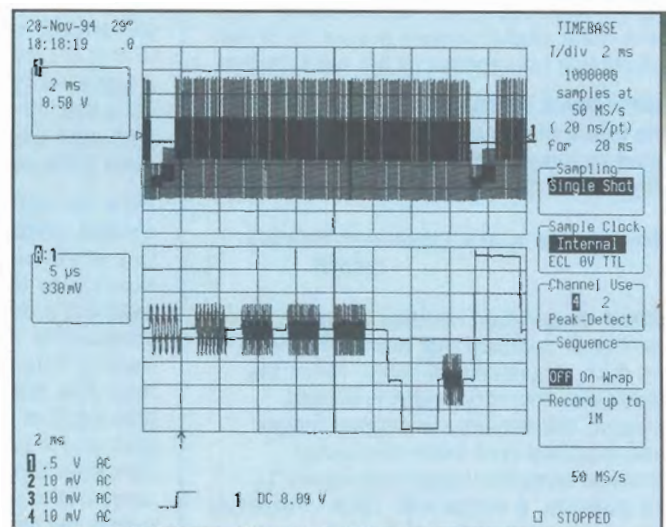

Figure 2b. Long memory enables a higher sampling rate: 1,000,000 samples captured. The zoom trace shows accurate details of the signal.



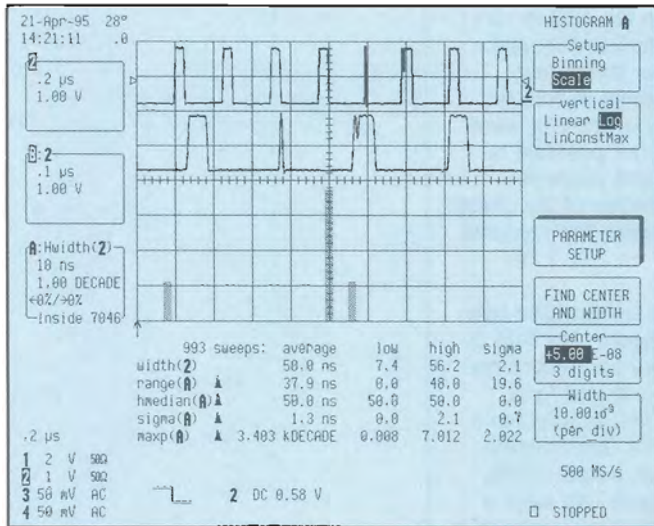

Figure 3. The top trace shows a clock signal with occasional problems. The zoom below shows one occurrence of the problem. On the bottom four divisions of the screen is a logarithmic scale with a histogram of pulse widths. 7046 pulses were measured - 12 with a width of 7.4 nsec, 12 with a width of 56.2 nsec and 7012 with the normal 50 nsec width.

The two factors of 1/2 cancel giving a resolution equal to the Sampling Rate divided by the number of points input to the FFT. Obviously it is important to capture the data at a high sampling rate. Long data acquisition memory plays an important role here since it allows the scope to have a fast sampling rate for a longer period of time. It is also clear that we can put more data points into the FFT algorithm if we capture more points in a long memory scope. But just capturing the points isn't enough. The DSO needs

in frequency information. Why would a vendor do this? The answer lies in the next important facet of memory in a DSO. An FFT calculation is complex and may require ten times as much RAM in the processing memory as the number of points input to the FFT algorithm. To perform an FFT on a 500,000 point waveform may require 5 Mbytes of RAM. You also need a fast powerful processor and numerical coprocessor to handle long data arrays. Both the RAM and the processor/coprocessor

to have the processing horsepower to actually compute the FFT on a long data array. As an example, one recently introduced digital scope can capture up to 500,000 points of data on a signal, but the FFT processing in the scope is limited to the first 10,000 points captured. This loses a factor of 50 in the resolution of the FFT compared to a scope which can process the complete 500,000 points. This is a tremendous loss

add considerable cost to a scope. Figure 4 shows the difference made by this trade off between price and performance. On the left an FFT is performed on the first 10,000 points of a waveform. On the right 1,000,000 samples are captured on the same waveform and an FFT is performed on the entire record. Both sets of data are captured at 500 MS/s sampling rate (so the highest frequency component measured is 250 MHz). The difference in frequency resolution is a factor of 100 (50 kHz vs 500 Hz). The frequency peaks on the bottom of the left screen image are very broad. In fact there is only a single point on each of them. On the right, the peaks are seen more accurately as being very narrow. In fact, the first peak is really two peaks at closely spaced frequencies. Those two peaks could not be resolved by the 10 K point FFT.

### CAPTURING A SEQUENCE OF SIGNALS WITH MINIMUM DEAD TIME

Many digital scopes have a mode which allows the user to segment the data acquisition memory into separate pieces. Each time the scope triggers, data is written into one of the segments of the memory then the scope quickly rearms itself for the next trigger. This process is useful in capturing signals where the dead time between events can use up the memory of the scope in recording uninteresting information. An example would be 5 nsec width laser pulses happening 200 times per second. If a scientist is examining a sample with a short lifetime, he would want to capture

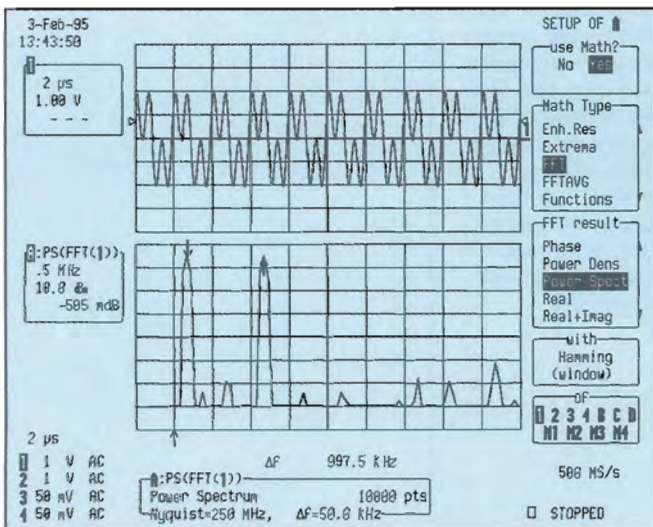

Figure 4a. An FFT of 10,000 points captured at 500 MS/s.  $\Delta f$  is 50kHz

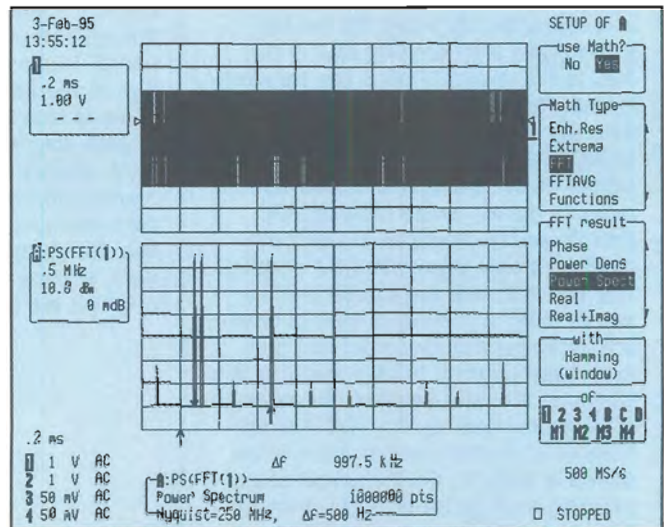

Figure 4b. An FFT of the same signal from Figure 4a with 1,000,000 points captured and analyzed. Now  $\Delta f$  is 500 Hz and the initial peak of Figure 4a is resolved into 2 peaks.

every laser pulse, but not the dead time between pulses. This mode is also useful for recording short irregularly spaced events such as intermittent failures in a circuit set to run an overnight test or capturing the effects of lightning bursts on communications lines. The user cannot predict when the event will occur and it is important not to miss any occurrences.

It is easy to see how the benefits of long memory be applied to using a fast capture-and-store mode as described above. The power of this triggering mode comes from dividing the acquisition memory into separate blocks which will each record one event. A longer memory allows the user to have more blocks and gives the flexibility to put a larger amount of memory into each block (thereby getting more points on each event of interest). A LeCroy 9300 series scope can record as many as 2,000 separate triggers in Sequence mode and use a total memory length up to 8,000,000 points. Also, each trigger has its own time stamp to mark when the event occurred. In contrast, competitors with 500,000 data acquisition points only have the capability to capture 910 events with a smaller amount of memory for each event and do not save the time of occurrence.

#### HOW LONG MEMORY AFFECTS PEAK DETECTION

In Peak Detect mode a digital scope will keep its ADC running at the full sampling rate even on slow timebases. In the first part of this article it was shown that this type of operating mode would require more memory than was available. Let's suppose the timebase is 2 msec/div (20 msec for the full screen) and the sampling rate of the ADC is 500 Ms/s (2 nsec per sample). In order to store the entire 20 msec of data the scope would require 10,000,000 memory points. In Peak Detect mode, a scope with 100,000 memory points would have its ADC sample and measure all 10,000,000 points but only store 100,000 of them. The 100,000 that are stored are chosen by looking at smaller bins of data and choosing the maximum and minimum (peak) values to be saved. In this example, the ratio between the number of measurements by the ADC and the number of memory points that can be stored is 100/1. So the scope could examine each group of 200 points as they are acquired and save only 2 points (the maximum and minimum values). In Peak Detect mode the timing resolution of the scope is severely com-

promised even though the ADC is running at its full rate because the user does not know whether the peaks occurred at the beginning, middle or end of the group from which they were saved. Normally it is not possible to perform math operations on peak detect waveforms because of the uncertainty of the time at which the samples were taken.

A long memory scope brings three benefits to peak detect mode. The first is that the longer memory can record normal data at full sampling rate for a longer period of time so the user isn't forced to resort to peak detect mode. Secondly, when in peak detect mode, the longer memory scope can save a larger proportion of the data (perhaps it can save 1,000,000 out of 10,000,000 samples rather than only 100,000). A third benefit is found only in LeCroy scopes. In peak detect mode a 9300 scope will allocate half of its memory to storing the data peaks as described above and the other half to sampling data in normal fashion. This allows the customer to view all the peaks and still be able to perform math. An example might be an engineer who is recording voltage on channel 1 and current on channel 2. On a third trace he displays power (channel 1 X channel 2) which is the real waveform of interest. But it is also important for him to know if there are any spikes in the current or voltage waveforms. With a 9300 series scope, he can do the whole job.

In buying \$5,000 computers we have become very expert at getting to know the amount of RAM, how much cache memory there is for the processor and the amount of local RAM on the video board. Those memories are very important to the power of the computer. The same is true with digital scopes. There is data acquisition memory, processing RAM, display memory and storage memory for both waveforms and front panel setups. The power of the scope is in its ability to capture, view, measure, analyze and archive signals—all of which are tied to its memory.



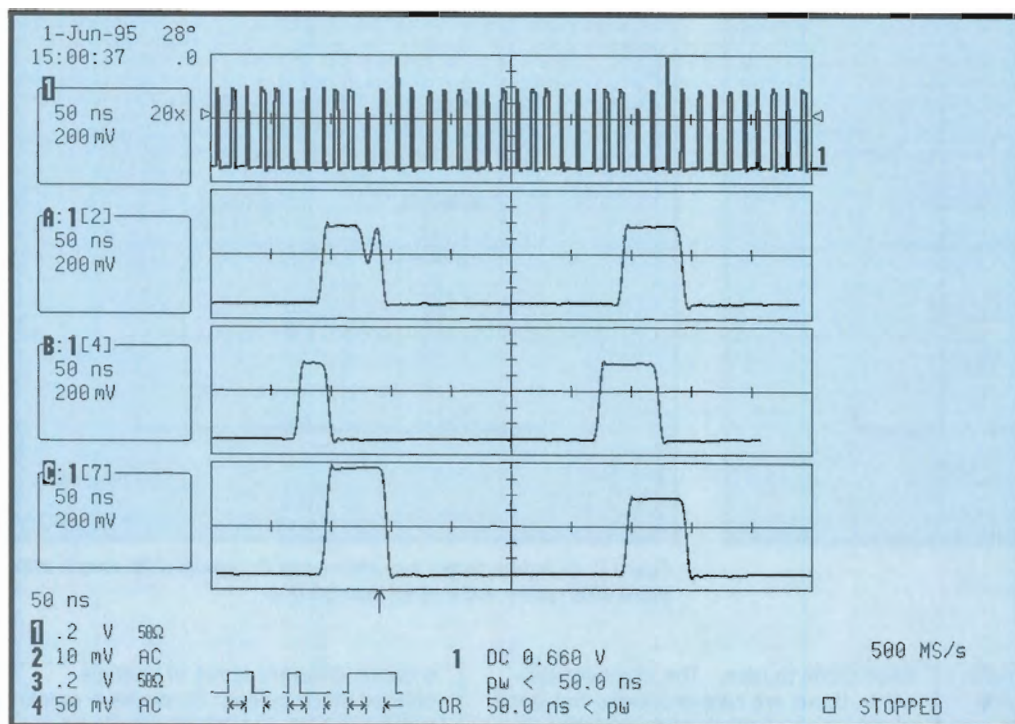

Figure A.

The most difficult problems to troubleshoot are those which are intermittent. This is especially true if the shape of the failing signal changes characteristic each time the failure occurs. The engineer does not know when to trigger the scope (because the failure is irregularly spaced in time) and he does not know what shape of signal to trigger on (because the failure does not always have the same characteristic). Since the digital oscilloscope has become the tool of choice for troubleshooting the easier problems in circuits, it would be helpful if their power could be applied in these cases also.

The power of a DSO is in its ability to capture, view, measure, analyze and document electronic signals. For the application described here the challenge is to capture a signal when the trigger conditions are unknown, view those signals which are aberrant, measure the aberrations, analyze the cause of the signal irregularities and document them. Let's suppose that the signal of interest is the master clock. Each clock pulse is about 1 volt in amplitude, 50 nsec wide and the clock period is 250 nsec. Looking at this signal on a digital scope gives a picture as shown in Figure 1. Unfortunately, something goes wrong with this signal occasionally. How do we track down the problem?

The first generation product offering by digital scope vendors to capture and view signal irregularities was standard edge trigger-

ing coupled with color graded persistence display. This was offered in 1990 by LeCroy's 7200A series and by other vendors. Under this mode the scope triggers many times on the signal of interest and displays the most commonly captured signal shape in red and least common in blue. Spectral shades between red and blue measure the frequency of occurrence of signals shapes which have "medium" probability. This mode provides some useful information for the engineer, but not a lot. There is a bright red trace that shows the normal signal shape and, if you were lucky enough to capture some of the failure modes, there are additional traces in other colors laid on top of the red one. There is no quantitative information concerning how often each failure type occurred. In fact, if two failure modes happen with equal frequency they come up in the same color and the display is confusing.

One of the major scope vendors announced in 1995 a new version of color graded persistence mode to find signal irregularities. The new version works in exactly the same fashion as previous scopes (described above) but there is an improvement in the trigger rate. This scope can trigger up to 100,000 times per second with up to 4 channels in each trigger for a total of 400,000 acquisitions. The new mode has a shorter "dead time" between triggers. Under best operating conditions, the scope is active 23% of the time (77% dead time). One catch is that the user has no

## Finding Intermittent Faults in Electronic Signals

This technical note discusses how digital oscilloscopes can be used to capture, view, analyze and document intermittent faults in electronic circuits. After discussing the older technique, color graded persistence, the article moves to newer tools including Exclusion Trigger, statistics on parameters and histograms.

Figure A. An intermittent fault in a clock circuit is captured 20 times. A compacted display of all 20 faults is shown in the top trace. The next three traces show the full detail of the 2nd, 4th and 7th events. For more details refer to the discussion of Figure 6.



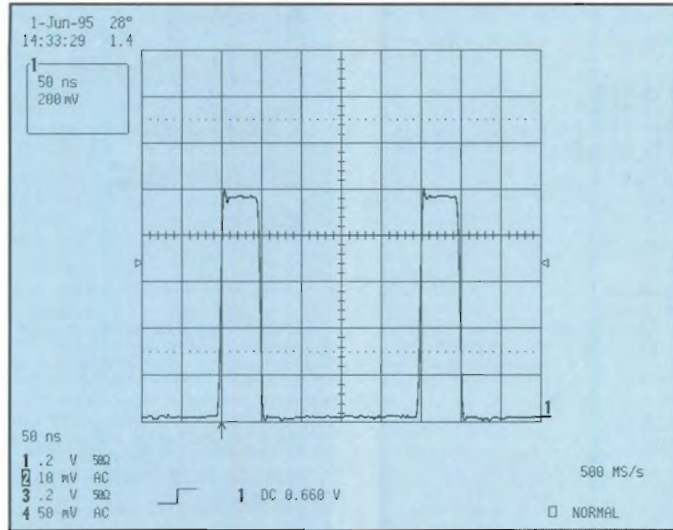

Figure 1. The normal signal shape

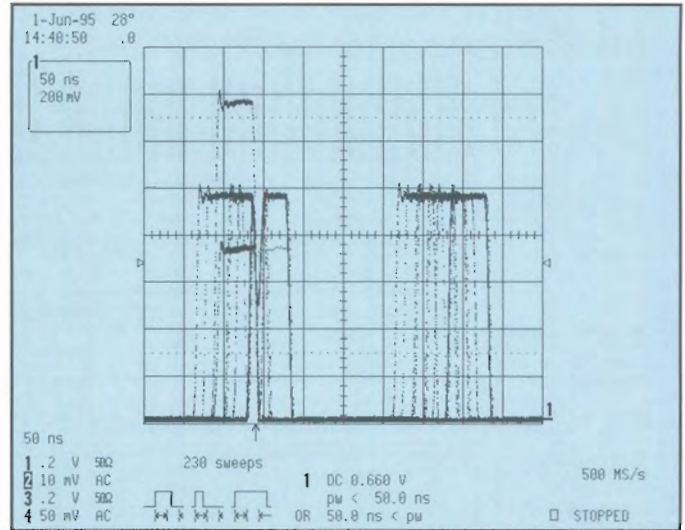

Figure 2. Exclusion trigger has been used to capture 230 events with pulse width pulse width other than 50.0 ns

control over the number of data sample points used to capture the signal—it is always 500 points. Many real world signals are complex and cannot be described using only 500 points. The color graded persistence mode has a maximum time constant of 10 seconds. The scope reverts to monochrome for infinite persistence. So in order to use the qualitative information in the color grading, it is necessary that the failure mode occur at least once per 10 second interval. Also, when your failure occurs, there is a 77% chance you will miss it. Suppose your circuit fails one per hour, the probability is that during a period of 4 hours the failure will occur 4 times, you will miss triggering on it 3 times and trigger on it once—and if you are in color mode you will have less than 10 seconds to hit the stop button to keep the picture on the screen when that one interesting trigger occurs. A significant annoyance that is often overlooked is that the engineer must be present when the glitch occurs and act in less than 10 seconds to stop the scope, otherwise, the glitch appears, and then disappears.

Clearly there are some drawbacks to the use of persistence mode in looking for signal instabilities. Fortunately, a much improved troubleshooting technique is now available. The new method improves the ratio of active time/dead time in capturing the signal and also greatly improves the ability to view, measure, analyze and document the signal aberrations.

Let's return to the problem of the 50

nsec clock pulses. The engineer suspects there are rare problems but does not know the nature of the fault(s). What the scope should really show to him is any pulse that is not 50 nsec wide, or any that are 50 nsec wide but have a glitch somewhere during that time or any clocks that are not the proper amplitude. He wants the scope to monitor the signal, ignore all the normally shaped pulses, keep the trigger circuit active by not triggering on the normal pulses and only trigger when the aberration occurs. In this manner the scope would be active nearly 100% of the time and the engineer would see only the signals of interest. This type of performance is now available in LeCroy 9300 series digital scopes. Furthermore there are excellent analysis tools that can be applied to the data.

The new trigger feature for LeCroy digital scopes is called "Exclusion Trigger." Under this trigger mode the user tells the scope to ignore signals with a certain width or period (the "normal" signal). The scope triggers only on irregularities. A typical setup is shown in Figure 2. The scope is set to trigger on any pulses which are longer than 50 nsec ("50 ns < pw") or on any which are shorter than 50 nsec ("pw < 50 ns"). A customer could watch the type of display shown in Figure 1 a long time on any vendor's scope without seeing the signal irregularities but by activating the Exclusion Trigger the display in Figure 2 quickly shows the type of signal irregularities that are present. In this case, the problem is unusually bad. There are

a dozen different types of wrongly shaped clock pulses. Some have amplitudes too high or too low, others have wrong widths while others have glitches near the leading or trailing edges.

If there was only one type of oddly shaped pulse the data in Figure 2 would be much easier to interpret. But real world failures are not so convenient. The persistence display is revealing a variety of oddly shaped clocks. In order to begin making measurements of the problem the user can touch a single button that requests Statistics on Parameters. Figure 3 shows the result. We now know the maximum clock width is 75 nsec while the minimum is 6.5 nsec. The period ranges from 14.3 to 251.5 nsec. We also know the amplitude range is .726 volts to 1.375 volts. This is a good start in making a measurement of the problem (already it is better than previously possible on any oscilloscope). But we can do much better.

The next step is to request the scope to capture a certain number of our "problem signals" so that we can get a better view and better analysis of the problem. This is done by choosing a number between 1 and 2000 and asking the scope to capture that number of triggers. Each trigger goes into a particular "segment" of the data acquisition memory. In Figure 4 the scope is capturing 20 individual triggers (note the number "20x" in the rectangle at the upper left of the display). In fact, the scope has acquired 6 sweeps and in each sweep there are 20 events.



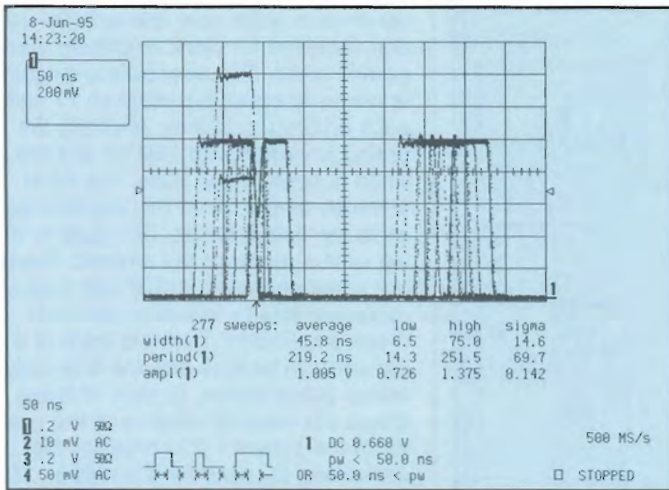

Figure 3. Using statistics on pulse parameters shows the worst case values of pulse width, amplitude and period for signals captured by the exclusion trigger.

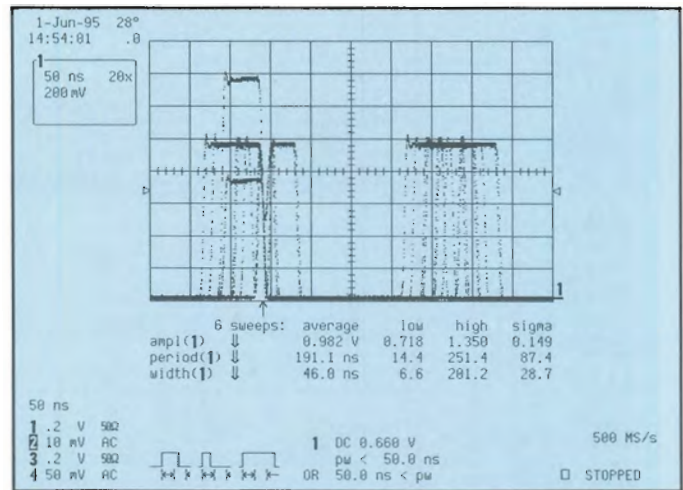

Figure 4. The oscilloscope is now capturing sequences of 20 aberrant signals. The 20 signals are displayed in persistence mode along with pulse parameter statistics.

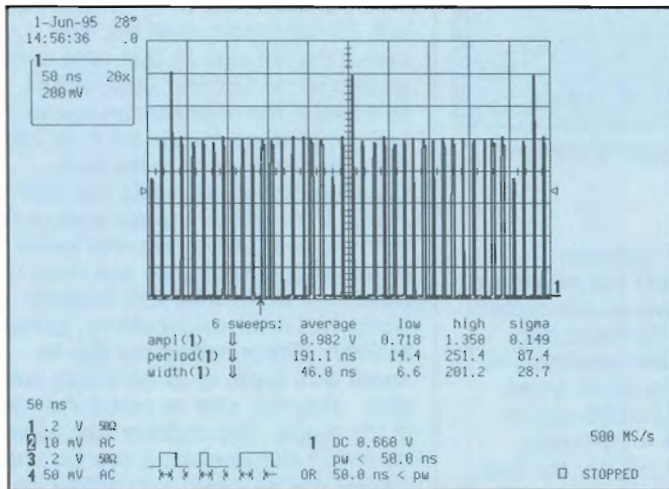

Figure 5. The same 20 pulses from Figure 4 shown in a compacted display of the 20 events.

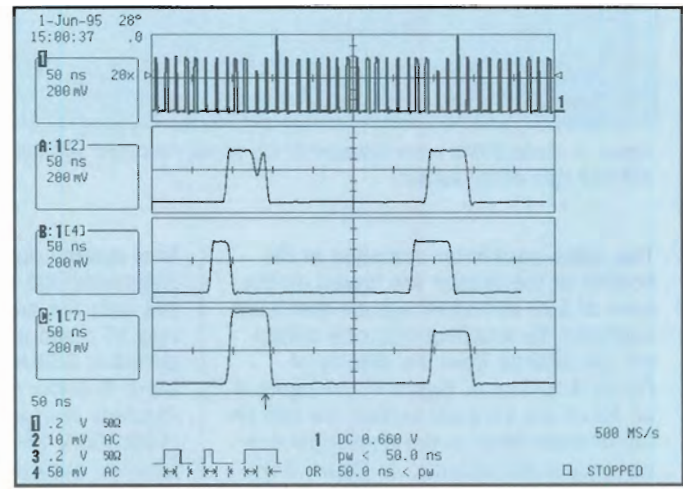

Figure 6. The compacted display of 20 events is on the top trace, on the other traces the zoomed detail of the 2nd, 4th and 7th event are shown.

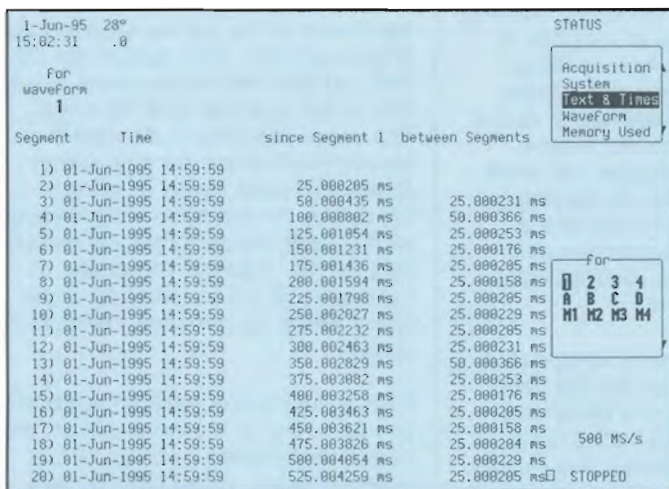

Figure 7. The date and time of each event that was caught by the exclusion trigger. The time between triggers is in the right hand column.

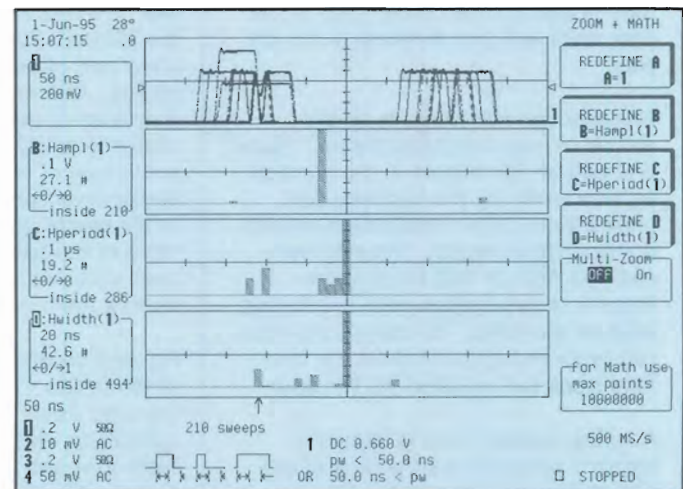

Figure 8. Bar chart showing histograms of the amplitude, period and width of events caught by the exclusion trigger.



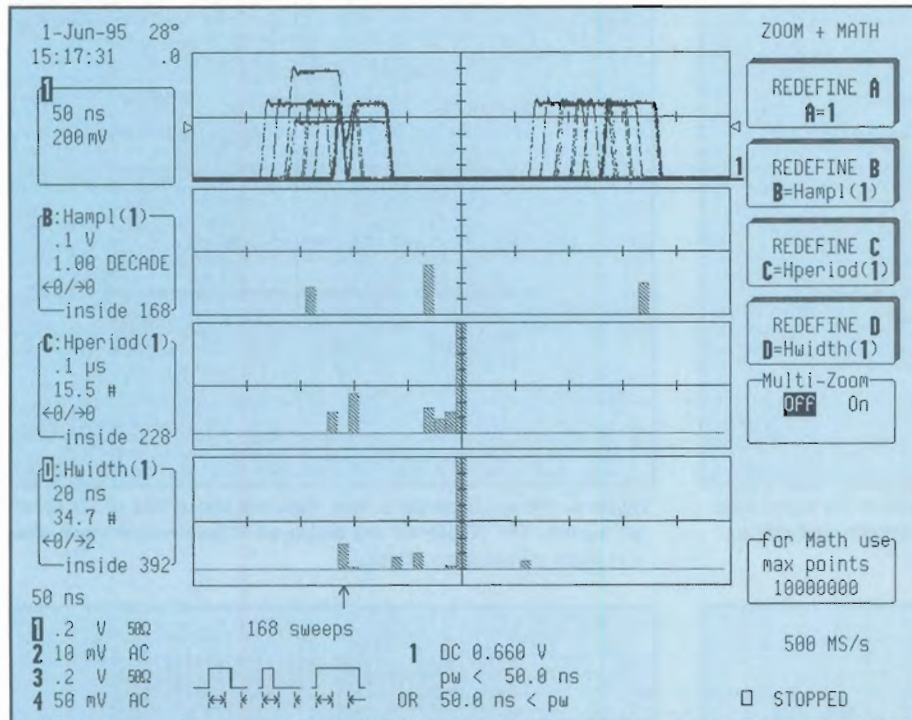

Figure 9. Trace B has been changed to log scale, for easier viewing of the shorter bars on the left and right of the screen.

The pulse parameter statistics at the bottom of the screen are based on the total of 120 abnormal signals that were captured. By touching only one button we can change from the display of Figure 4 to that of Figure 5. In Figure 4 all 20 of the irregular pulses are laid on top of each other in the traditional persistence mode display. In Figure 5 the 20 individual signals are shown going from left to right. All 20 events are compactly shown (2 per division). For example, the events with large amplitude pulses can be clearly seen in the first, sixth and last divisions of the display.

The user can now zoom in on the details of each individual failure. Figure 6 shows all 20 failures in the compacted view mode on the top trace and shows three of the individual events on the next three traces. The engineer can now REALLY SEE the failures. Trace A shows a glitch near the trailing edge of the pulse. In Trace B the clock has been chopped off short. In the third trace the amplitude is too large.

A further analysis tool is shown in Figure 7 which shows the time of the first of the 20 triggers, the difference in time between the first trigger and each of the other 19 events and the time elapsed between each trigger and the one just prior to it. By looking at the

final column (labeled "between Segments") the engineer can notice that the aberrant pulses are usually occurring 25 msec apart. His basic clock period is 250 nsec. The conclusion is there is some problem which occurs regularly after each 100,000 pulses ( $100,000 \times 250 \text{ nsec} = 25 \text{ msec}$ ). Now the engineer is ready for the final level of analysis. He knows the high and low ranges for the parameters that describe the failure and he has seen what the individual failing signals look like. He also knows the timing between the failures. But it would very nice to know how often each type of failure occurs. Can we quantify the relative frequency of each failure type? And it would be extremely helpful to have some type of scope display that could be observed while making adjustments to the circuit to see whether one or more of the failure modes becomes more common or less common while making the adjustment.

Figure 8 shows the persistence display of the failure modes on the top trace. The next three traces are bar charts quantifying each of the failure types. Trace B shows amplitudes. The oscilloscope can be requested to automatically set the scale of the bar chart so that the data is displayed clearly or the user can set the scale to specific values. In this case the engineer has set the cen-

ter of each scale near the nominal values expected for clock amplitude, period and width. The amplitude histogram is centered about the value of 1V and each division is 100mV. Similarly the period is centered at 250 ns and the width is centered at 50ns. The most common amplitude of the aberrant pulses is the tallest bar at .96V (just to the left of the center of the screen). There are small peaks at .718 V and 1.35 V corresponding to failure modes with these amplitudes. The next trace is a bar chart of periods and the final trace shows pulse widths. In each of these traces the nominal value is at the center of the screen ( 250 nsec for the period and 50 nsec for the width). The bar chart of periods has a scale of .1 usec per horizontal division while the width is on a finer scale of 20 nsec per division. The bar farthest to the right on the bottom trace is the failure mode with 75 nsec width while the bar toward the left side on that trace corresponds to the smallest pulse widths (6.6 nsec). The engineer can quickly see which failure modes are most common from the heights of the bars. Quantitative measurements can also be made. The engineer can put cursors on each bar chart (which are also called histograms) to determine how many pulses out of the total 210 irregular clocks had a certain amplitude, period or width. These histograms can be saved onto floppy or as hard copy outputs. They can also be saved internally in the scope. The engineer can adjust his circuit and compare a new bar chart against one he saved from before the adjustment.

Some failure rates may be much more rare than others. For example in looking closely at the top bar chart in Figure 8 there are very short bars in the left half and right half of the screen in addition to the large bar near the center. The scope can present the data in a format which allows the rare events to be seen more clearly by going to a log display for this trace while keeping all the other traces in their normal (linear) format. Figure 9 shows how a log display of the bar chart for amplitudes shows the very rare events more clearly.

Finding intermittent faults in electronic circuits is one of the most difficult and important problems a design or test engineer faces. It can often be very time consuming. In the past, persistence displays were used to spot signal irregularities because there were no better tools. By providing the user new



technology that is much more powerful, LeCroy offers superior capability to capture, view, measure, analyze and document these signals. For the engineer and his company, it means the chance to get a product to market more quickly by solving problems faster.





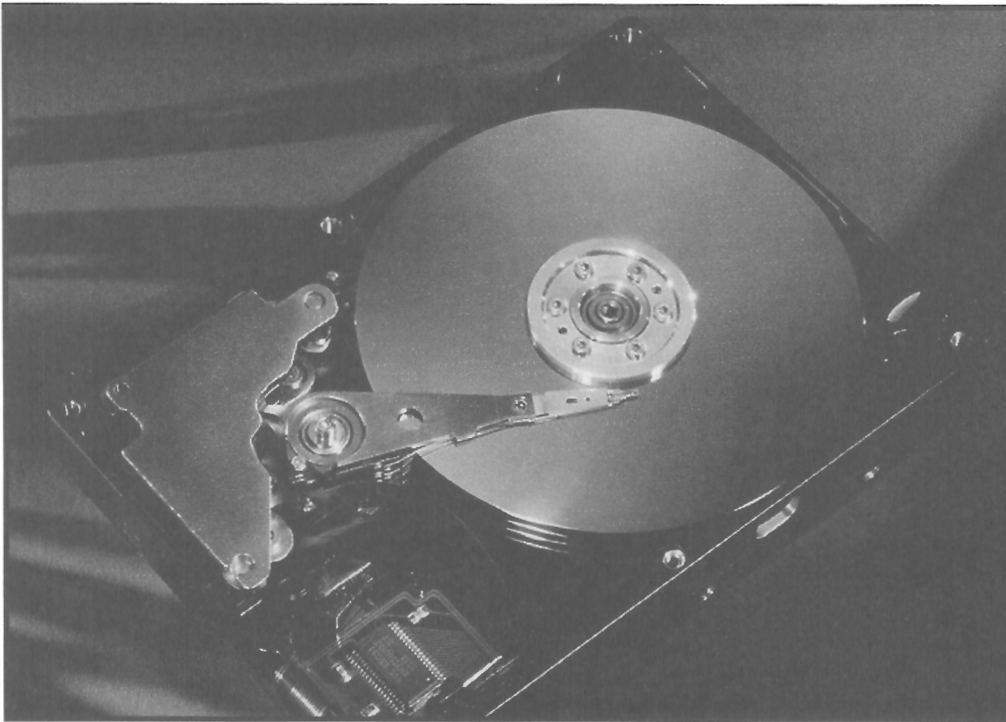

## CAPTURING THE SIGNAL

The first requisite for analyzing a signal is to capture it in the scope. The data which is captured must have sufficient detail to accurately depict the signal. In a digital scope this translates to fast sampling rate and a long memory. The total length of time which can be captured in a digital scope whose sampling period is

$\Delta t$  is:

$$\text{Capture Window} = \Delta t \times \text{Memory Length}$$

The longest capture window currently available in a DSO is 8 million memory points at 0.5 nsec per sample (2 Gs/s sampling rate) for a total capture window of 4 msec. This can be extended to 8 msec or 16 msec by adjusting the sample period to 1 nsec or 2 nsec. Short memory scopes, even if they contain a fast sampling ADC, cannot capture long times with good sampling fidelity. For example, a scope with only 500K of memory would have to space the samples 32 nsec apart when capturing 16 msec regardless of the speed of its ADC (32nsec X 500,000 = 16 msec).

The digital oscilloscope has replaced its older analog counterpart in a wide variety of applications due its ability to measure, analyze and archive data but it was difficult until the last few years for the data storage industry to make use of the benefits of digital scopes simply because the memory in early DSO's was too short. Now that the memory is sufficient, the next task is to apply analysis tools.

## MEASURING WAVEFORM PARAMETERS

There are a wide variety of parameters which can be measured using a digital scope. These include specific disk testing parameters such as the time between peaks in a data stream, the time between peaks and troughs, peak to trough amplitude, peak to peak amplitude, widths of peaks, the amount of time a peak spends above a threshold and a variety of other parameters commonly used to characterize the performance of data storage devices. In a long data stream these parameters can be separately measured for every local peak/trough. For example, if there are 100,000 peak/trough events then the DSO will measure 100,000 values for the time between peaks and display the results either as a histogram or as a simple table listing the maximum value, minimum value, average value and standard deviation. This allows the DSO to perform many jobs including functioning as a time interval analyzer.

## PRML ANALYSIS PACKAGE

The PRML option which recently became available in digital scopes provides the ability to perform correlation based measurements between sections of two waveforms or autocorrelation measurements between different sections on the same waveform. It includes a correlation math function and two correlation based parameters, auto-correlation signal to noise (acsn) and non-linear transition shift (nlts). The non-linear transition shift parameter can be used to measure other correlation based properties of magnetic media such as overwrite.

## Making PRML Measurements with Digital Oscilloscopes

Recent advances in signal capture and analysis capabilities in digital oscilloscopes allow them to perform the measurements required for PRML analysis. This article will discuss the methods through which autocorrelation, auto-correlated signal to noise and nonlinear transition shifts may be analyzed in a DSO.

*This article first appeared in Data Storage Magazine, June 1995.*

*Disk Drive photo courtesy of Quantum Corporation.*



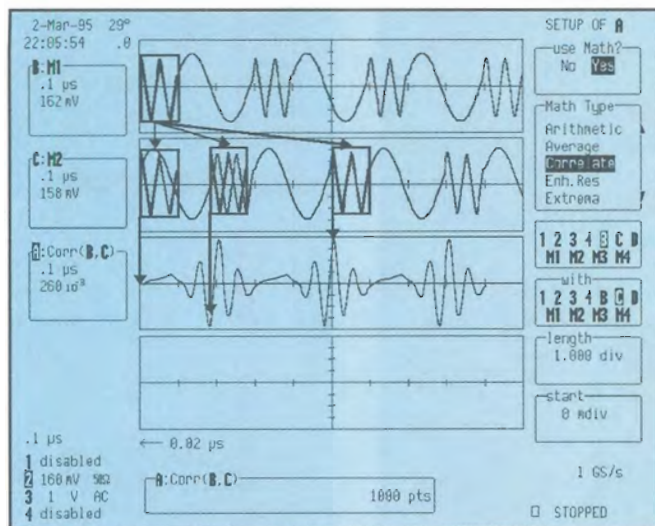

Figure 1. The first division of the top waveform is compared to the second waveform. The result of the correlation measurement is shown in Trace A.

The acsn parameter can be applied to any periodic waveform. Since periodic waveforms are, by definition, identical periodically any deviation is due to uncorrelated noise sources. By performing an auto-correlation calculation of the waveform over successive periods the level of less than perfect correlation can be measured and using this measurement the noise level can be derived by acsn.

The nlts parameter provides the ability to measure all echo's in an auto-correlation calculation of a disk waveform. This includes the NLTS echo, the second bit adjacent echo and the overwrite echo. The nlts parameter performs NLTS averaging, pattern length searching and limit checking to reduce the effects of noise and provide more accurate measurements.

### THE CORRELATION FUNCTION

The correlation function performs a measurement of the correlation of one section of a waveform to other equal length sections of the same waveform or of another waveform. When the correlation is performed between various sections of a single waveform it is referred to as auto-correlation. If the shapes of the two waveform sections are identical the correlation function is maximized. The correlation scale is normalized to range from +1 (waveform sections are identical) to -1 (waveform sections are exactly inverse). A correlation value of 0 would mean no correlation. A noiseless periodic waveform will have perfect correlation (correlation value of 1) when the start of the sec-

ond section is an integer number of periods later than the start of the first section.

In Figure 1 the first section of the upper trace (B) is being correlated to the waveform below it (C). The result is drawn on the lower trace (A). The beginning of C matches poorly to B, so the correlation result is near zero. About two divisions later on the screen the two waveform sections are very nearly inverses of each other, resulting in a large negative correlation. In the

center of the screen the two waveform sections match and the correlation is near 1. Since the waveform section length is one division of the screen, the last point at which the correlation can be calculated is the ninth division of the screen. Past this point the calculation would require data past the end of the screen on trace C.

Figure 2 shows the correlation function being applied to a waveform from a disk drive. This function can be very useful in measuring the cycle length of a complex periodic waveform. In this case, the signal shape from the first 4 divisions on the screen in channel 2 is compared against channel 2. The result is on trace A.

If you examine the upper signal you will see that it begins to repeat near the center of the screen. Since the timebase for channel 2 is .2 usec/div this means the period of the signal is near 1 usec. On trace A the cursors on the correlation function show a more exact reading of 980 nsec.

### AUTO-CORRELATED SIGNAL TO NOISE

The acsn parameter which can be calculated by a digital scope provides an

auto-correlation measurement of the signal to noise for a repetitive signal through use of the correlation function discussed above. In order to perform the measurement a signal must be acquired containing at least two periods of the waveform and the user should have an estimate of the period length for the scope to examine. The scope will examine the waveform using the estimated period supplied by the user and can then calculate a more exact period using the technique shown in Figure 2. This is crucial because variations in disk rotation speed make it difficult for users to provide an exact amount time length for a waveform. Using the period provided as a starting point, the scope performs an auto-correlation and looks for a peak near the provided period. The location of the top of the peak is the time at which the waveform begins to repeat itself. The scope notes the time of this peak and performs an autocorrelation based on this period. The value of the autocorrelation function at the period peak, R, is used to calculate the auto-correlated signal to noise :

$$S/N = R/(1-R)$$

$$\text{acsn (dB)} = 10 * \log_{10} S/N$$

An example is shown in Figure 3. The entire waveform is shown in the top trace on the scope (channel 2). Below it trace B shows the auto-correlation calculation with five peaks. The initial peak corresponds to the first pattern at the beginning of the waveform correlating 100% with itself during the first 980 nsec which is the pattern length ( the expansion on trace C is the first peak

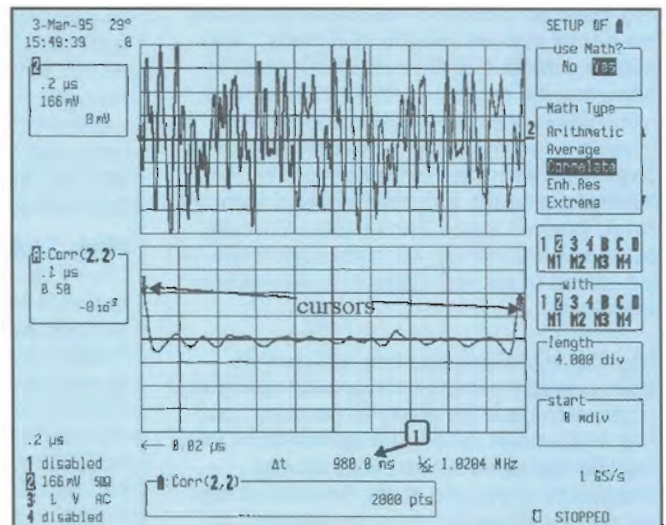

Figure 2. Autocorrelation reveals the underlying period of this waveform is 980.0 nanoseconds.



of trace B and has a peak value of 1.000). The second pattern does not correlate 100% with the first one due to the presence of noise (the expansion on trace D is the second peak of trace B and has a peak value of .987). The value of the acsn parameter for this waveform is

$$10 * \log_{10} [.987 / (1 - .987)] = 18.8 \text{ dB.}$$

In order to improve the accuracy of the acsn measurement, the scope can average several acsn measurements—even if the waveform is only acquired once. If the number of periods in the input waveform is 26 or more, the acsn parameter is measured for each of the periods and the results averaged. If the input waveform has 25 or fewer periods, the scope can perform 25 acsn measurements by incrementing the start point of the waveform 25 times (each increment is 1/25 of the waveform period length). In addition to providing the average of the acsn measurements, the user can observe each of the separate values in a histogram. In manufacturing, it may only be necessary to verify that all values of the acsn parameter are higher than a certain specification. This means that no recording of the waveform contained a noise level higher than allowed. For ISO 9000 purposes, a simple table can be archived showing the highest, lowest and average value of the acsn measurements.

### NONLINEAR TRANSITION SHIFT

The nlts parameter provides a measurement of the nonlinear transition (or adjacent location) shift through use of autocorrelation. The scope needs to acquire a signal with a minimum of two full cycles of the test pattern and the user also needs to estimate the pattern length and a delay value. The scope can take the period length estimated by the user, verify it and possibly adjust it to a more accurate value (as discussed in the first paragraph concerning acsn measurements) to match the exact disk rotation speed.

The test pattern used to calculate nlts should be a pseudo random sequence that will create an echo in the auto correlation function corresponding to the nonlinear transition shift. Typically this sequence is a 127 bit pattern based on an  $X^7 + X^3 + 1$  polynomial and an nlts echo appears at a pattern delay of 20% of the input pattern length. In fact, several commonly measured disk drive waveform attributes can be measured from the polynomial

waveform through the use of different delay values. An example of an echo is shown in Figure 4. This is the same test waveform shown in Figure 3 but now the zoomed detail on the third trace (trace C) shows an echo occurring at  $t = 196.0 \text{ nsec}$ . The correlation coefficient is  $-0.062$ .

Ideally, the value of nlts is:

$$\text{nlts}(\%) = -200 * \text{Correlation Coefficient (at the specified delay)}$$

Noise on the input waveform will effect the correlation coefficient's value and therefore also affect the nlts measurement. In order to get the most accurate measurement, the scope can average several nlts values. If the number of pseudo random patterns in the input waveform is 26 or more, each nlts measurement is made and the results averaged. If 25 or fewer patterns are captured, the nlts calculation can be made 25 times by incrementing the basic waveform by lengths equal to 1/25 of the period of the test pattern. As with other parameters, the user can view the nlts measurement on a specific piece of the waveform, obtain a table with the average/maximum/minimum values of the nlts measurements or choose a histogram showing all the nlts results.

Larger numbers of pseudo random patterns captured in the input waveform will result in smaller effects of noise on the nlts measurement. In order to further correct for the amount of noise (as measured by the acsn parameter) each nlts measurement can be adjust-

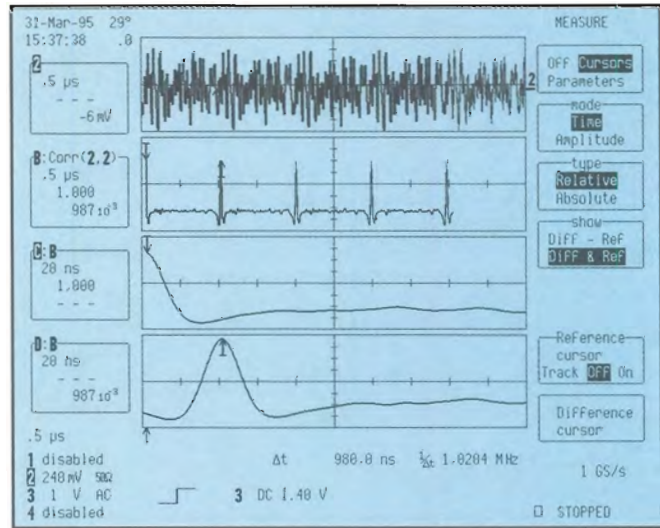

Figure 3. Autocorrelation of the first section of the waveform with itself gives an ASCN coefficient of 1.000 (Trace C). The presence of noise when comparing the first 980nsec of the signal to the second 980nsec lowers the coefficient to 0.987.

ed by dividing the nlts value by the acsn peak value for that particular cycle of the test pattern. For the example shown in Figure 4 this would result in an nlts value of:  $-200 * (-0.062) / .987 = 12.2\%$ . Figure 5 shows a typical waveform display along with the values of acsn and nlts. In this case a more accurate value (12.65%) with 4 decimal place resolution is obtained due to averaging of 25 calculations as discussed earlier.

When making statistical measurements in the presence of noise it is important to understand the repeatability of the measurement. The chart in Figure 6 provides the standard deviation of the nlts parameter for varying amounts of noise and numbers of repetitions of the pseudo random sequence in the test waveform. The sampling rate used was 4 samples per bit cell and the input waveform had 20% nlts. Note that the worst case for the standard deviation is 1.08% when capturing only two repetitions of the signal at a noise level of 17dB.

Waveform Attribute	Bit Cell Location	Delay (% of Pattern length)
Adjacent Cell	25.5	20.07%
Second Adjacent Location	30.5	24.02%
Initial Magnetization	45.5	35.83%
Interaction Interface	60.5	47.64%

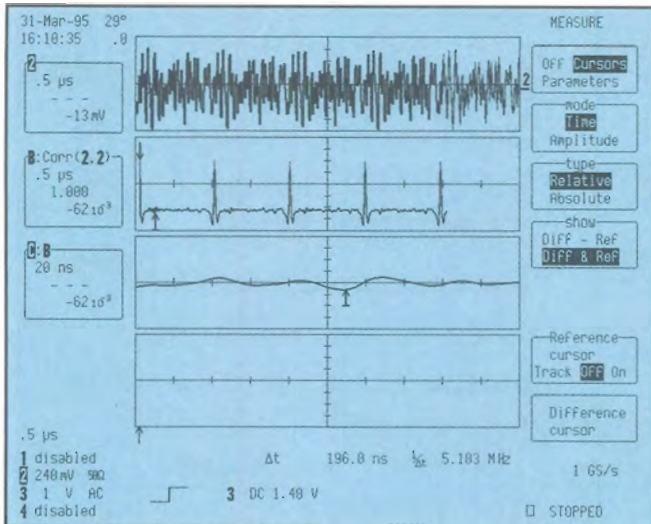

Figure 4. The upper trace is the raw waveform. Middle trace is the correlation function. The lower trace an expansion of the middle trace revealing an echo at 196.0 nanoseconds.

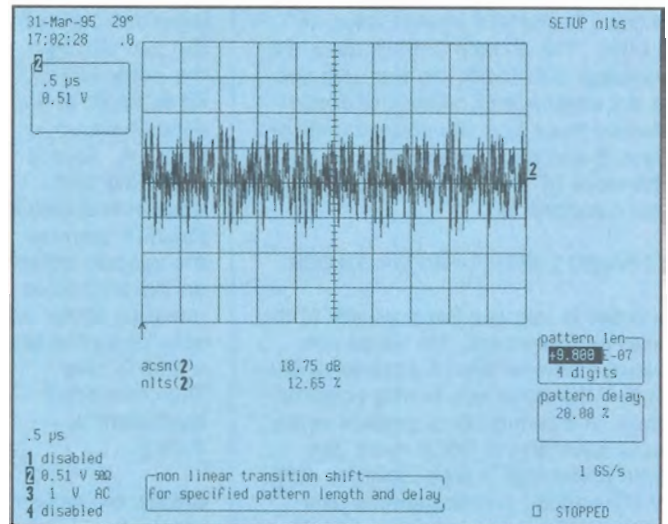

Figure 5. A waveform measurement with autocorrelated signal to noise and Non-Linear Transition Shift parameter measurements.

To perform measurements on long data arrays requires substantial processing horsepower. The processing engine used in the DSO mentioned above with 8 Mbytes of data acquisition memory is a 32 MHz 68030/68882 with 16 Mbytes of RAM. However, 16 Mbytes of RAM may not be sufficient for some data storage engineers who desire the ability to view zoomed details in multiple sections of a waveform, compute parameters and perform simultaneous correlation functions. A 64 Mbyte (retrofitable) RAM option is newly available for those applications. At this point, the digital scope has become a combination of an oscilloscope that provides a view of the signal and a powerful workstation to process the data and archive it. By performing the calculations inside the digital scope, considerable time is saved compared to transferring raw waveform data over GPIB to make the calculations in a computer. The test results can be saved to a computer via GPIB or onto internal floppy disk, internal printer or PCMCIA portable hard drive in the scope. The price of a high powered DSO capable of performing disk drive measurements as described above can be \$15,000 to \$30,000 (depending on the number of channels, memory length and math options). It is often a less expensive, faster and easier to use alternative compared to the variety of test equipment needed to capture, view, measure, analyze, archive and print disk drive signals.

ACSN	# Pattern Repetitions	NLTS Standard Deviation
26 dB	2	0.44%
	10	0.28%
	25	0.20%
23 dB	2	0.59%
	10	0.32%
	25	0.26%
20 dB	2	0.65%
	10	0.42%
	25	0.28%
17 dB	2	1.08%
	10	0.57%
	25	0.35%

Figure 6. The repeatability of Non-Linear Transition Shift measurements as a function of the amount of noise present and how many times the test pattern is repeated.





## Introduction

The rapid evolution of communications poses new and challenging technical problems and a need for improved instrumentation. Despite the variety of communications media, there are many similarities in the problems encountered when developing, testing and debugging communication links. Testing is typically performed by transmitting and receiving known patterns of data which are most often repetitive, whereas real-life conditions often require single-shot capabilities due to the unpredictable nature of the data.

Because of their ability to display single-shot as well as repetitive events, digital oscilloscopes are ideal for the communications field. Advanced digital oscilloscopes also offer a wealth of features including sophisticated triggering, processing of data, computer control, etc. These features can be invaluable to engineers faced with the problem of capturing and analyzing communications signals.

This note presents typical applications and shows how particular features of LeCroy oscilloscopes can be beneficial.

### DIGITAL OSCILLOSCOPE OVERVIEW

The transition from analog to digital technology in oscilloscopes brings several advantages which include:

- Capture of single-shot as well as repetitive events.
- Steady, non-volatile display of waveforms.
- Event archiving (computer storage and paper hardcopy).
- Viewing of pre- and post-trigger data.
- Digital control of the acquisition conditions.

While the above features are common to most digital oscilloscopes, LeCroy oscilloscopes also provide innovative and unique features particularly valuable in communications. These are:

- Long memory per channel, 10 kword to 1 Mword, allow viewing of long-lasting events with very high time resolution.
- Simultaneous sampling on all channels to ensure correct phase analysis of complex waveforms.
- XY display with dedicated cursors for relative phase and amplitude measurements.
- External clock input to sample the input waveform synchronously with a user-defined clock (particularly useful for constellation displays).

## Benefits of DSOs in Communications

This technical note discusses the application of digital oscilloscopes to a variety of problems encountered in communications. Examples are given of how to use the benefits of a DSO in examining phase shift keying, frequency shift keying, full duplex signals, gaussian minimum shift keying, quadrature amplitude modulation and ethernet LANs. Use of a persistence display and Pass/Fail testing are examined.



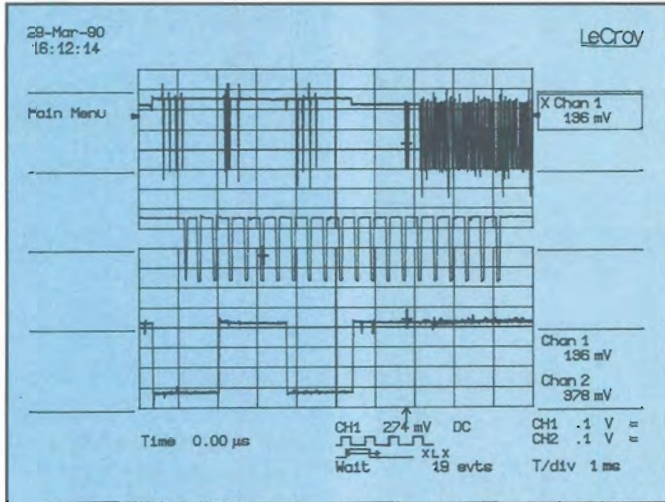

Figure 1. Interval trigger provides a stable trigger on a Phase Shift Keyed signal.

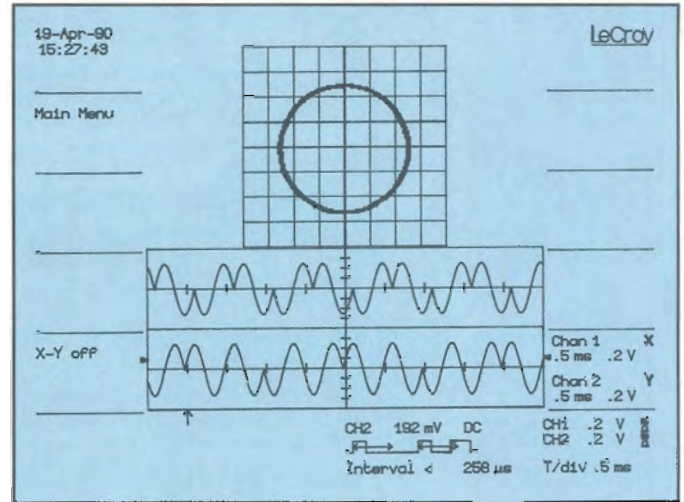

Figure 2. The phase trajectory of the I and Q components of a PSK signal.

- A wide choice of signal processing options, including Fast Fourier Transform (FFT) which allows the oscilloscope to act as a spectrum analyzer.
- Variable and infinite persistence display modes, for eye diagram display.
- PASS/FAIL testing with "template" waveforms and parameter limits representing popular telecom standards.
- Time-qualified trigger, where the distance between the arming condition and the actual trigger is defined in terms of time.
- State-qualified trigger, where the presence of a particular logic state, for instance on Channel 2 and/or External, is a condition for Channel 1 to trigger.

The following examples highlight some applications of these features.

#### PHASE SHIFT KEYING

Phase Shift Keying (PSK) is a popular way of transmitting digital data through modems and telephone lines. It is based on the phase modulation of a continuous sine wave. While the structure of these signals is quite simple, oscilloscopes with just a threshold trigger have difficulty displaying them. The continuous change of phase results in a display with excessive jitter. A trigger which operates only when the oscilloscope senses a variation in the phase

of the signal is much more effective.

LeCroy oscilloscopes are capable of sensing the width of the input pulses or, alternatively, the time distance separating successive pulses. A change of phase in a continuous sine wave can be detected as a sudden variation of the period.

Figure 1 shows such an example. The trigger occurs on Channel 2 (lower trace). The requirement is that the separation between two cycles must be smaller than the sine wave period (Interval smaller than 258  $\mu$ sec). The trigger position in time is indicated by the small arrow at the bottom of the screen. As can be seen, the trigger takes place after a 180° phase change.

#### CONSTELLATION DISPLAY

The two waveforms in Figure 1 are the I (In-phase) and Q (Quadrature) components of a transmitted PSK waveform, acquired simultaneously. An XY display of these two waveforms shows their phase trajectory (Figure 2).

A constellation display can be generated by clocking the I and Q components with the system clock and showing an XY display of the sampled values. This can be easily done since LeCroy oscilloscopes can be used with an external clock.

Figure 3 shows the constellation display obtained by the two waveforms of Figure 1. The slight spread of the points in the constellation display indicates a small phase jitter between the I

and Q signals.

The phase jitter can be measured exactly by locating the cross-hair cursor at the two extremes of a spot, as shown in Figures 3 and 4. The difference of the two angles seen on the right-hand side of the XY display gives the amount of jitter. In this case,  $\Delta\theta = 50.8^\circ - 46.3^\circ = 4.5^\circ$ .

#### FREQUENCY SHIFT KEYING

Frequency Shift Keying (FSK) is another common way of transmitting digital data. It's based on modulation frequency of a carrier.

The upper waveform in Figure 5 shows an example of a binary frequency modulation. This is a relatively simple signal, but very difficult to trigger on without resulting in a jittering display. Any one of the pulses composing the waveform can be a potential trigger. The signal in Figure 5 was captured with a LeCroy oscilloscope by setting the instrument to trigger only when a change takes place in the carrier period (pulse width less than 3  $\mu$ sec). The trigger position is indicated by the arrow at the bottom of the grid.

The lower trace in Figure 5 shows another feature of LeCroy oscilloscopes; the ability to calculate the FFT of the input waveform. Two frequency peaks are clearly visible. The two cursors, set on the two peaks, measure a frequency difference of 100 kHz.

#### FULL DUPLEX LINE

A full duplex line is a two-way link between two communication terminals, where transmission occurs in both



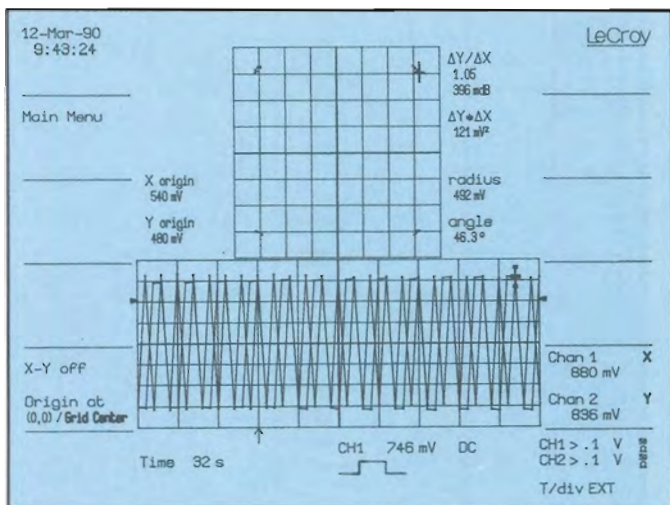

Figure 3. Constellation diagram of a PSK signal.

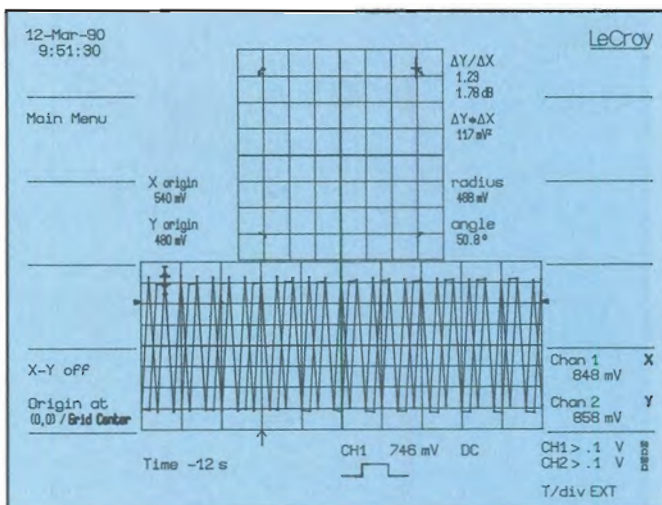

Figure 4. The same constellation diagram of a PSK signal as in Figure 3, with the crosshair cursor used to measure the [h]jitter.

directions simultaneously. In order to distinguish the direction of the data, carriers at two different frequencies are normally used. Each terminal isolates the carrier bringing data from the other terminal, by applying a suitable filter to the signal.

The upper trace in Figure 6 shows the data flow in a full duplex line. The bottom trace shows the FFT Power Spectrum of the same waveform. The two carriers are clearly visible. The cross-hair cursor measures the peak frequency of the first carrier (1.195 kHz) and the associated power (-8.40 dBm).

One more feature is used to provide the frequency spectrum in Figure 6.

The time domain waveform is quite noisy and the FFT of a single waveform would provide a noisy FFT spectrum. This would reduce the chances of clearly identifying the two carriers. In Figure 6, the FFT spectrum shown was obtained by averaging individual spectra (244 times). Random noise effects are dramatically reduced, making the two frequency components clearly visible.

### GAUSSIAN MINIMUM SHIFT KEYING

Gaussian Minimum Shift Keying (GMSK) is a type of modulation typically used in digital mobile telephones. The upper trace in Figure 7 shows one of the components of a GMSK signal. Again, the sophisticated trigger capabilities of the LeCroy oscilloscopes are

employed. Triggering at the beginning of individual data streams can be obtained by requiring a pulse separation greater than the longest separation expected in the data stream (150  $\mu$ sec in this case). The deep acquisition memory (up to 2 MBytes/channel) also allows the user to catch a long data stream and to zoom in to see the fine details of the waveform. The lower trace in Figure 7 is a 20 times expansion of the upper trace.

The two waveforms at the bottom of Figure 8 are the I and Q components of a GMSK signal taken with a LeCroy oscilloscope, simultaneously acquired as they came out from a transmitter. The XY display at the top shows the corresponding phase trajectory. The

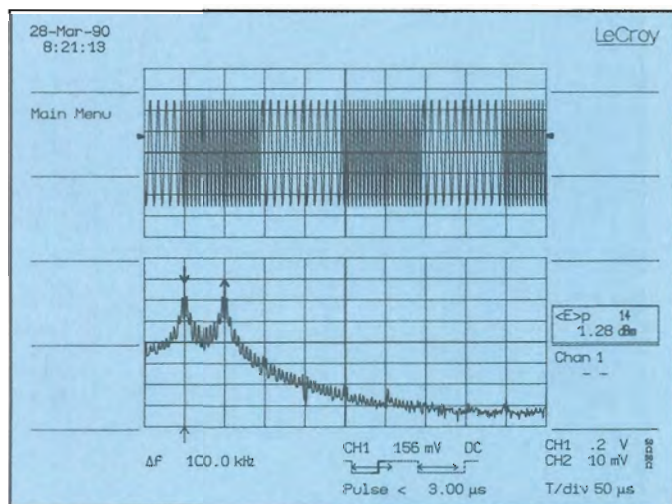

Figure 5. An FSK signal and its frequency spectrum.

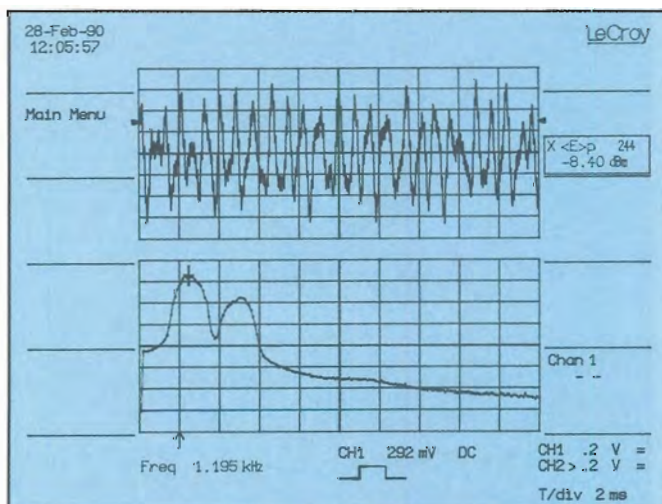

Figure 6. Signal captured on a full duplex line and its corresponding frequency spectrum.



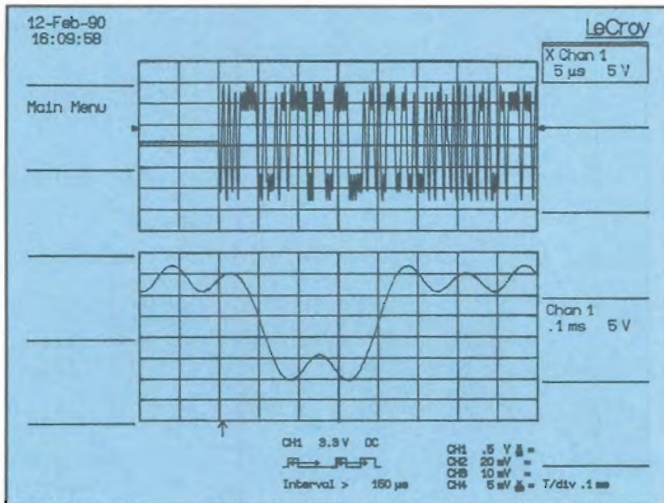

Figure 7. Interval trigger used to capture a GMSK signal.

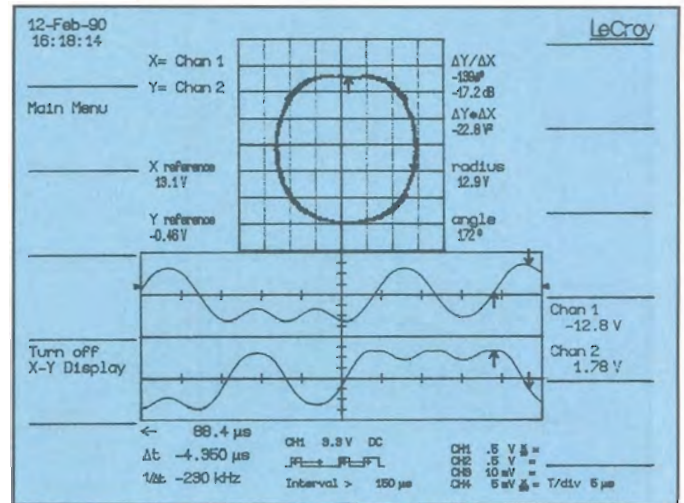

Figure 8. Phase trajectory of the I and Q components of a transmitted GMSK signal.

asymmetry in the circle at the point of the upward arrow is indicative of a saturation effect. This effect is also visible in the time domain on the Q component (lower trace), but not as clearly as in the XY display. The possibility of positioning a cursor in the XY display, as well as on the waveform in the time domain, facilitates the use of the XY display to identify the problem in the time domain.

In Figure 9 the GMSK signal has been transmitted, then received and decomposed again into its I and Q components (lower two traces). The XY display clearly shows the degradation of the signal due to noise and to the non-ideal characteristics of the receiver.

### QUADRATURE AMPLITUDE MODULATION

Quadrature Amplitude Modulation (QAM) is another well-known modulation technique for achieving more efficient use of the available bandwidth. It consists of two amplitude-modulated carriers summed in quadrature and, therefore, it can also be viewed as a combination of amplitude and phase modulation. If, for instance, the amplitude of each carrier is allowed to have four different states, each carrier will transmit two bits per baud. The total waveform will, therefore, carry a total of four bits and the constellation diagram would then contain 16 points arranged in a rectangular constellation (16-QAM). This is exactly what can be seen in Figure 10 showing

the XY display of the I and Q components of a 16-QAM signal. The two signals have been simultaneously sampled by the system clock sent to the external clock input of the oscilloscope.

The 16 possible states are clearly shown. By using voltage cursors (not shown) it is possible to verify the symmetry of the states. The cross-hair cursor shown provides the relative phase of the I and Q signals (45.1 degrees), the distance from the center of the grid (1.416 V), and the ratio of the I and Q amplitudes (in this case equal to 1).

### VARIABLE PERSISTENCE

The variable persistence feature allows accumulation of successive events on

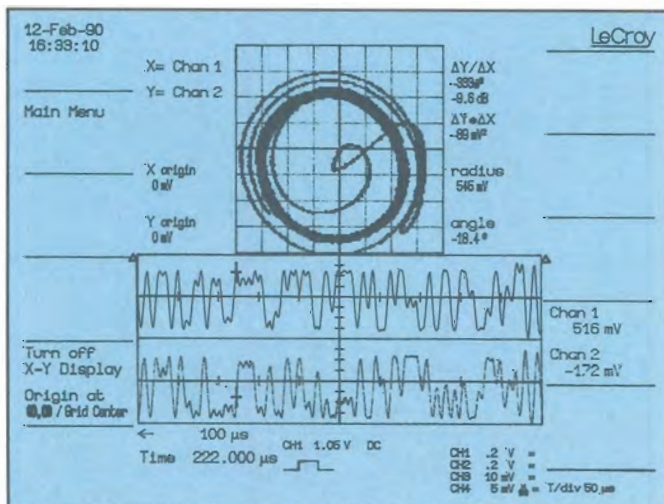

Figure 9. Phase trajectory of the I and Q components of a received GMSK signal.

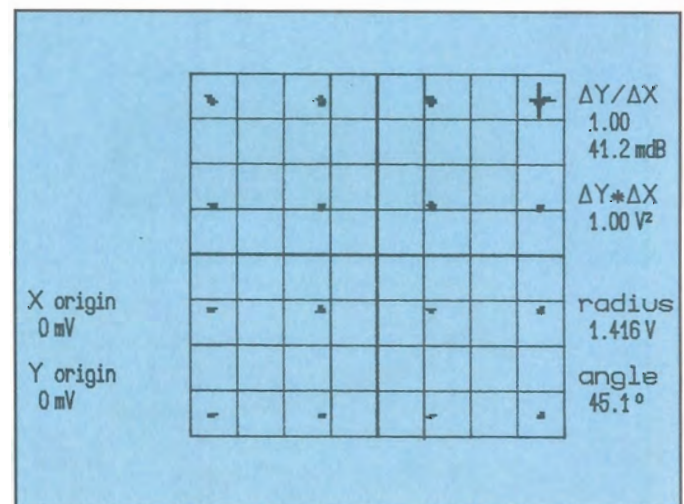

Figure 10. Constellation display of a 16-QAM signal.



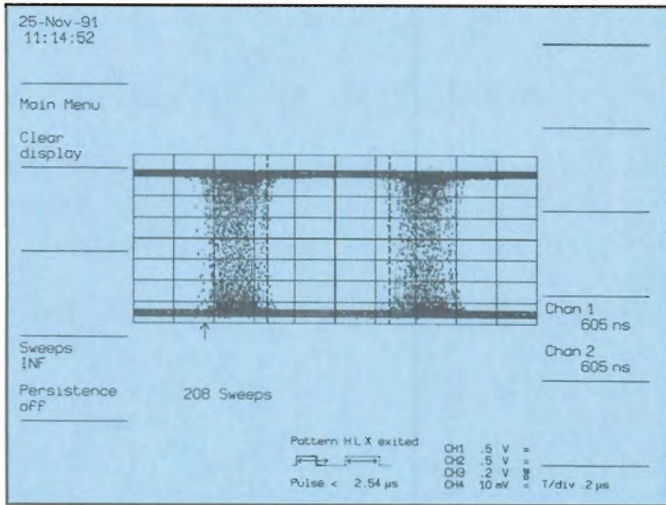

Figure 11. Example of an eye diagram using variable persistence.

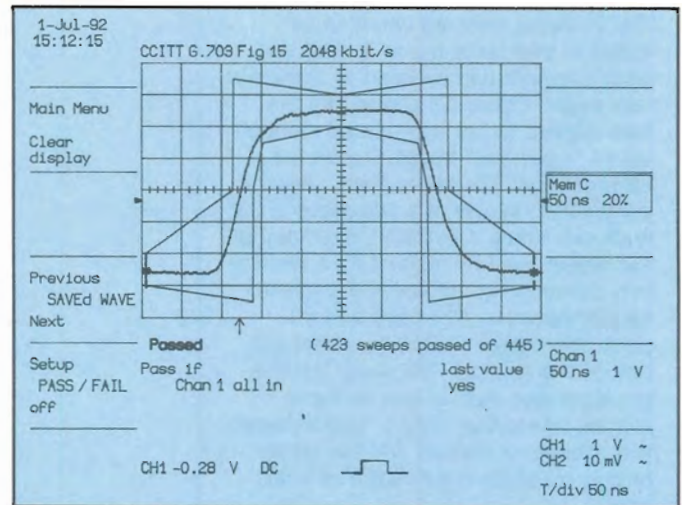

Figure 12. Automatic PASS/FAIL testing against a telecom template.

display, so that the user can estimate the evolution in time of a given phenomenon. In communications this feature is useful to build up eye diagrams, showing the time or amplitude jitter in a given bit stream.

Figure 11 shows an example of such an eye diagram: the two vertical time cursors offer an easy way of measuring the opening of the eye over time. Two similar horizontal voltage cursors allow measurement of the opening of the eye in amplitude.

### PASS/FAIL TESTING

The PASS/FAIL package, standard in all LeCroy oscilloscopes, permits multiple tests on an acquired waveform. The tests can be executed both on pulse parameters and/or against a tol-

erance mask. The tolerance mask can be defined by the user, or downloaded from either the optional memory card, portable PCMCIA hard drive (9300 family) or the built-in floppy disk (LS-140 and 9300 families) or an external computer.

LeCroy offers an optional memory card or floppy disk which is preloaded with 23 telecom templates taken from the following standards: ANSI T1.102, ANSI T1.403, CCITT G.703, and CCITT1.430 (ISDN).

Figure 12 shows one such telecom template PASS/FAIL test being executed.

### TESTING AN ETHERNET LAN

Ethernet is a local area network which works on the assumption that each local user can sense the state of a common broadcast line before attempting to use it.

A data packet can have a maximum size of 1526 bytes, that is 12,208 bits. With a bit lasting 100 nsec, this means that a packet can have a maximum length of 1,220.8 μsec. A digital oscilloscope sampling at 100 MS/sec allows capture of the individual 100 nsec long bit, but capture of a full packet requires up to 122,080 words of memory.

The 9300 series scopes offer models with up to 2 Mword of memory per channel.

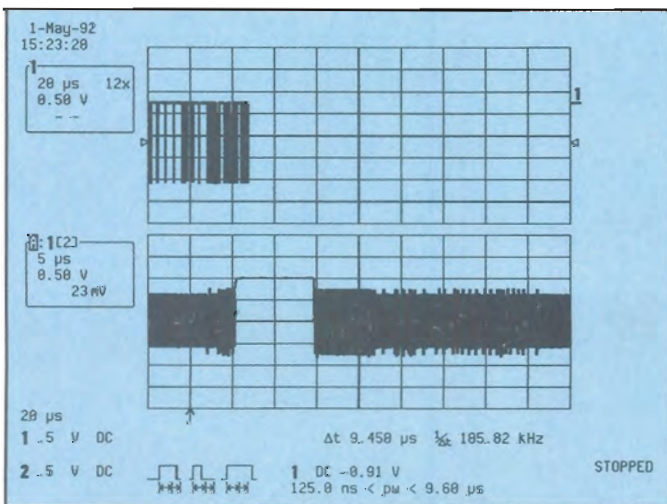

Figure 13. Capture of collisions on an Ethernet bus.

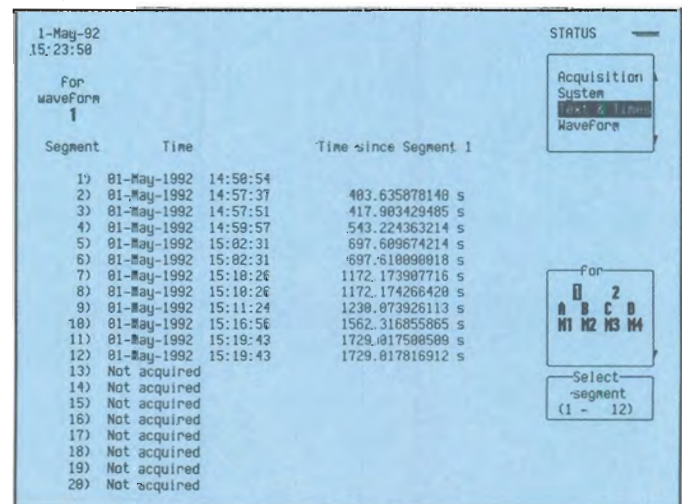

Figure 14. Time stamps associated with the collisions of Figure 13.

The 2 Mword memory can also be sliced in segments (up to 2,000) and each segment can be used to acquire a new event. Figure 13 shows this feature applied to the unattended monitoring of "collisions" happening on the Ethernet bus. The upper trace shows a compacted display of a sequence of 12 such collisions. A collision is defined at the trigger level by requesting a separation between two successive packets varying between 125 nsec and 9.6  $\mu$ sec (the trigger conditions at the bottom of the display). The lower trace is the expanded view of one of these events, where the "illegal" gap between two packets is visible. The two cursor arrows measure a gap width of 9.45  $\mu$ sec.

Figure 14 shows the time stamps associated with each individual collision. The instrument provides both the absolute trigger time, with resolution of one second, and the time relative to the first trigger, with nanosecond resolution.

**Acknowledgments:** We wish to thank Prof. J. Sloziar and Prof. C. Kunze of the Engineering School, Yverdon, Switzerland, for their help in the preparation of this document.



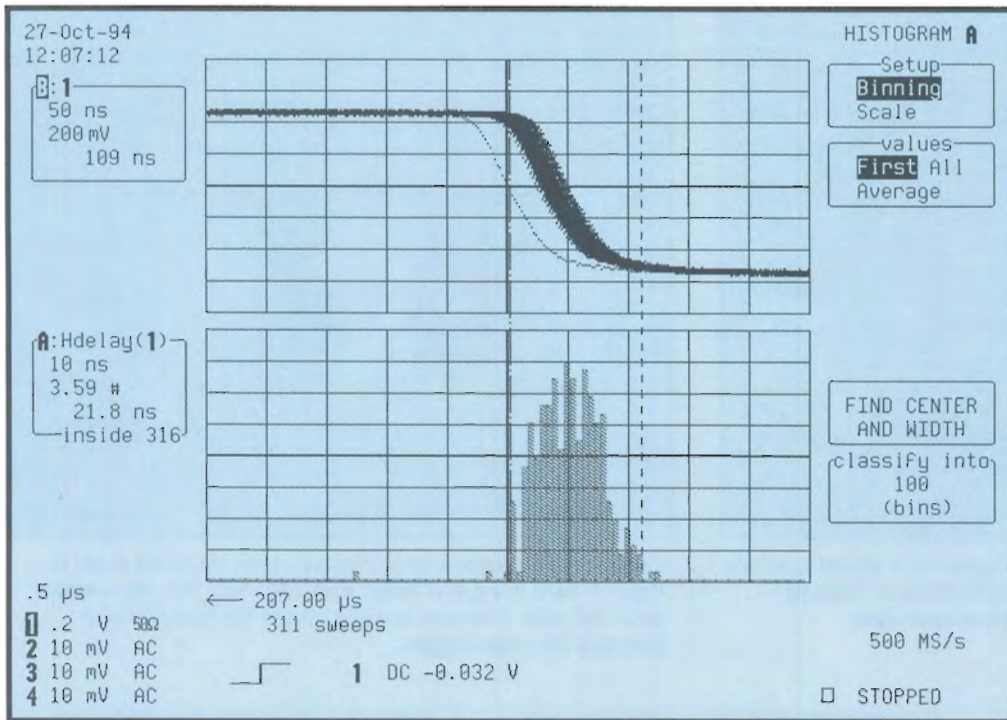

## GENERATING TEST SIGNALS

The Arbitrary Waveform Generator (AWG) is a powerful tool which has been available for more than five years. Although the AWG is an excellent instrument for testing wireless designs, the problem with first generation AWG's was the difficulty in creating waveforms. Creating complex equations to describe a signal or creating multiple waveforms which could be linked to create a test sequence required expert understanding of the AWG and several hours of programming. Also, many early AWG's had only one output channel while real world applications required two or more signals.

How have these difficulties been addressed in the newer AWG's? Nearly every wireless design starts as a model in PSPICE, MathCad, MatLab or some other modeling program. LeCroy's LW400 series can import the files from these programs and generate signals from them. Suppose "designer A" has a PSPICE model of a new transmitter but hasn't built one yet while "designer B" has his first prototype of the receiver ready for testing. "Designer B" simply gets the PSPICE file from "designer A", puts it into his AWG and starts his testing. Not only can he test his own prototype, he may be able to give valuable advice to "designer A" on how to improve the shape of the transmitter output.

The most powerful new capability in AWG's is "live" waveform control. Very often an engineer would like to be able to quickly

test the response of a circuit when some part of the signal has a variation in amplitude, width or timing. In the past, an engineer might have created multiple waveforms which had a series of slight changes. By linking these waveforms together and sending them through the AWG the result was accomplished — but it wasn't quick. The LW400 series AWG's from LeCroy have knobs labeled "Amplitude", "Duration", etc. The user puts cursors around the part of the signal to be changed and turns the knob. The screen of the AWG shows the variation of the signal "live" as it is being adjusted and also outputs the signal to the device under test. A test which might have taken hours is now done in minutes.

An example, Figure 1 on the next page, shows the display of a digital oscilloscope capturing and analyzing a spread spectrum wireless signal. The product under design is a security system which encodes a spread spectrum communications signals with pseudo-random number "chipping" sequences. A two channel AWG is used to generate the signal and the encoding sequence for the device under test. The resulting signal is captured by the scope on the top trace in Figure 1. The lower trace shows an FFT of the signal. Some scopes can perform a 1,000,000 point FFT which gives 100 times better frequency resolution compared to other scopes whose analysis package supports 10,000 point FFT's.

## New Tools for Wireless Design

**Advances in Arbitrary Waveform Generators and Digital Scopes Make it Easier to Capture, Measure, Analyze and Archive Data**

Whether your company makes cellular phones, pagers, wireless networks or security systems there are generic problems faced by all design engineers working on wireless circuits. We would all like to make better measurements of signal amplitude, pulse widths and timing jitter. In general this requires driving well controlled signals into the device under test, capturing the output, analyzing the data and archiving the results. The whole process is strongly influenced by the need for FAST time to market for new products — without any bugs or glitches. There are new tools available which add capability at all steps of the process.

*This article first appeared in Wireless Design and Development Magazine February 1995.*



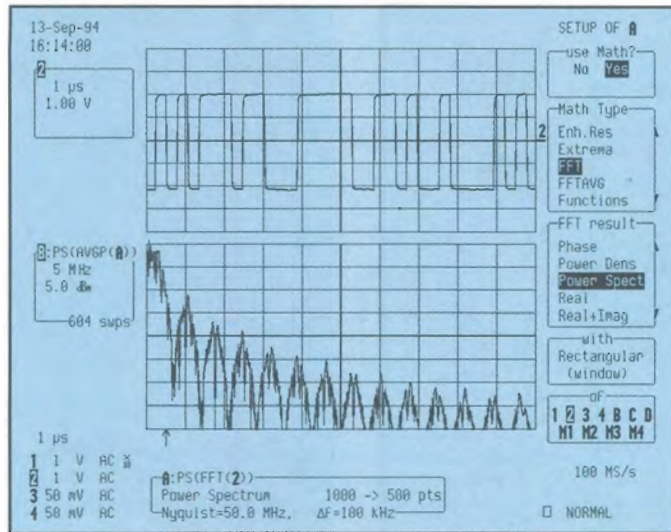

Figure 1: The top portion shows an AWG output of a spread spectrum communications signal which has been encoded by a "chipping" sequence. The lower portion shows a frequency analysis of the signal.

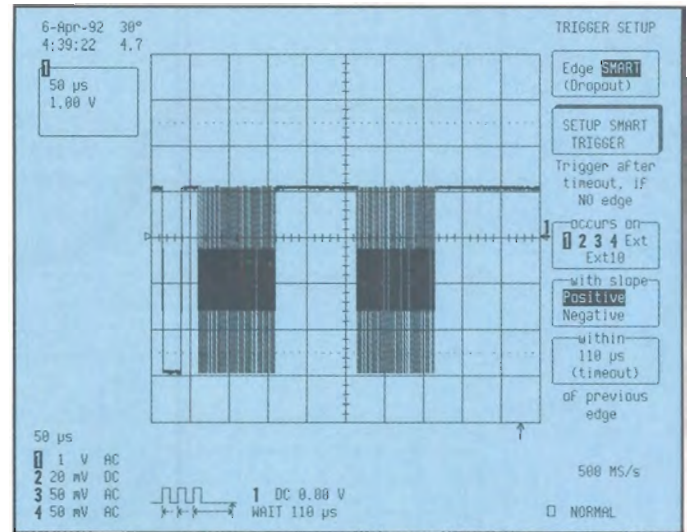

Figure 2: A DSO triggers on a "dropout". Note the scope is set to trigger if there is a gap of longer than 110 usec. Two data packets occur, but when a network collision causes the third packet to disappear the scope triggers.

Some first generation AWG's could import waveforms that had been captured by a digital scope. However, each vendor typically only knew how to transport waveforms from their own AWG to their own scope and the process required hooking up a computer between the two instruments. A new tool available in AWG's is the ability to import waveforms from DSO's manufactured by LeCroy, Tek or HP. Also, the need for an intermediate computer has been eliminated. The AWG has a pull down menu to select the scope type. The two instruments are connected with a GPIB cable and the AWG can download the file directly. If the user has a device which is working properly, each important test point can be probed with a scope and the results downloaded to the hard drive inside the AWG. These "golden" waveforms can then be used to test other devices. They can also be edited to add noise, jitter, amplitude/width changes or other kinds of tests. Both the original waveforms and the edited versions can all be saved in the AWG, viewed on its screen and edited without need of a computer.

#### CAPTURING THE DATA

Once you have generated all these wonderful test signals to exercise your design the interesting part of the job comes next — looking at the output of the device you are testing and figuring out what is going on. One of the keys to getting new products out is debugging the problems and characterizing circuit performance so the test department

(and marketing) know what to expect. New capabilities in digital scopes reduce the time to capture, analyze and archive measurements of circuit performance.

The first step in looking at the output of the device under test is capturing the signal. The two key performance factors which affect data capture are the triggering capability and memory length of the DSO. Several trigger types are particularly useful for wireless designers. One of the most common is a pulse width trigger. By setting the scope to trigger on "Width < XX" the user can trigger on narrow pulses or glitches. By setting the trigger for "Width > YY" the engineer can look for wide pulses. You can also request the scope to trigger on "XX < Pulse Width < YY" in order to trigger on a particular width of pulse. Most scopes also have a pattern trigger. New DSO's from LeCroy can trigger on entering or exiting a pattern of up to five signals and some have a time-qualified pattern trigger which allows the user to specify the amount of time a pattern should be present.

A particularly nasty problem to troubleshoot in a communications device is an intermittent hang-up. Suppose there is a problem which occasionally causes data to stop. You would like to trigger on that condition and look at various signals leading up to the time of data interruption. But how can you tell your scope to trigger on the condition of "No signal present". Figure 2 shows a new

trigger for communication designers called a "Dropout" trigger. The user sets the trigger level and specifies an amount of time. If the signal under observation fails to cross the trigger level during this amount of time the DSO triggers and captures the event.

Another trigger for wireless designers is the "Interval" trigger. The pulse width trigger discussed above allows the user to look at the time between the rising edge and falling edge of a pulse. But sometimes the crucial condition is the timing between two rising edges (or two falling edges). An "Interval" trigger is used to set the trigger condition on the time elapsed between two edges that have the same sign.

Once you have triggered your scope, it will record the signal into its data acquisition memory. There is a close relationship between memory length and quality of data capture. To get the best details on the signal the scope should be sampling at the maximum rate of its ADC. The longer the memory is, the longer the time period that can be recorded at that maximum sampling rate. It is possible now to acquire 8 million sample points with 0.5 nsec resolution (2 GS/s sampling rate).

#### ANALYSIS TOOLS

Measuring signal characteristics and analyzing circuit performance is the heart of the engineer's job. Suppose the job is to characterize the rising edge of a particular signal. Figure 3



shows a typical measurement. In this case the scope is measuring the amplitude, overshoot, risetime and the delay of the edge compared to a reference (i.e. jitter). Near the bottom of the screen the scope shows the average value of each measurement, the maximum value, minimum value and standard deviation. These statistics on the pulse parameters allow for worst case analysis of circuit performance. If the user makes an adjustment to the circuit under test there is a button for "clear sweeps" which erases the previous data and allows the engineer to quickly see the effect of the change. Most DSO's can measure parameters but it can be a time consuming chore to analyze the statistics on the parameters. This new tool makes the job much faster.

You may need to go one step further in analyzing circuit performance. In Figure 3 the scope captured a signal several hundred times but only two results are being displayed (the maximum and minimum values). There can be important factors hidden from the user. If the key problem is frequency stability a display such as that shown in Figure 4 may lead to an immediate understanding of the problem. The upper part of Figure 4 is a persistence display of the signal under test. It is clear that there is a band of frequencies corresponding to the slightly different periods of the sinewaves. If you knew the maximum and minimum values of the frequencies, a worst case performance analysis could be made.

But that wouldn't help you understand where the problem was coming from. The lower trace in Figure 4 is a bar chart of the measured frequencies. The DSO has measured the frequency 774 times. The most commonly measured frequency has the highest bar on the chart. The resolution of the horizontal scale is 0.5 kHz per division with 10 bins inside each division. The user can set the center frequency, request more bins for finer resolution or a larger range to see wider variations. This particular picture makes it immediately obvious that there is not simple noise causing jitter on the basic period. There are two separate peaks which may be caused by instability in the performance of a part (maybe the oscillator isn't locked to one frequency the way it should be). This type of histogramming analysis tool available in LeCroy's 93XXWP03 package is also very useful for analyzing pulse amplitudes, widths or timing jitter.

The analysis tools discussed above make new demands on the operating system of oscilloscopes. To acquire, measure and display this type of analysis in real time requires new processing engines. The newer DSO's use 32 MHz 68030/68882 processor/coprocessors with up to 16 Mbytes of RAM. If you want the timing precision of long data acquisition memories and then need to process those memories as large arrays to produce useful analysis then the amount of RAM is just as important as the

amount of data acquisition memory.

### ARCHIVING DATA

It is common for engineers to be required to produce progress reports. These documents frequently take the form "At the beginning of the reporting period the problems in the new product were X and Y. Changes were made. The result is shown below." It is very useful for such a report to contain pictures of the signal under discussion or — even better — a picture of the signal which also shows worst case parameters or histogram analysis. Some engineers who have to produce weekly progress reports spend a significant fraction of their time creating the report.

New tools make this job much faster. Many scopes can save files in TIFF format which can be imported into popular word processors. However, the only storage device available was floppy disks which are slow and have low capacity. Thanks to technical advances in the disk drive and DSO industries plus the advent of the PCMCIA standard for peripheral devices there is a handy piece of new hardware available for LeCroy scopes — the portable hard drive. These drives are PCMCIA Type III devices which pop in and out of scopes or computers with much the same ease as a floppy but are much faster and have capacity greater than 100 Mbytes.

So now you can save your raw data and analysis onto the hard drive as

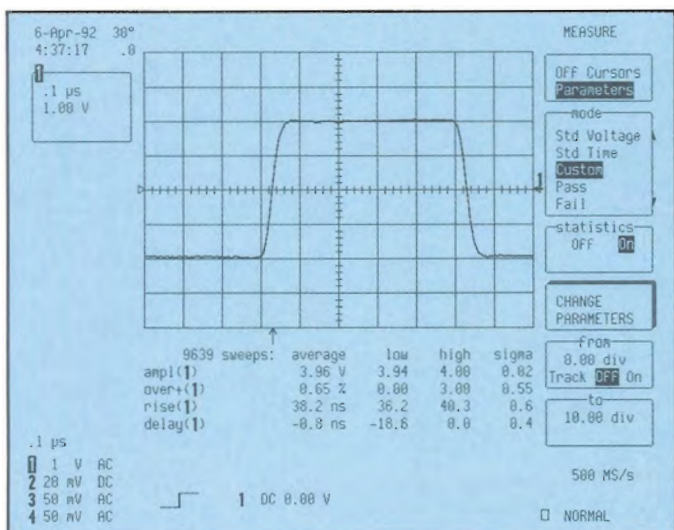

Figure 3: A DSO measures best and worst case shape of a data bit. In this case the maximum and minimum values are shown for pulse amplitude, positive overshoot, risetime and delay (timing jitter).

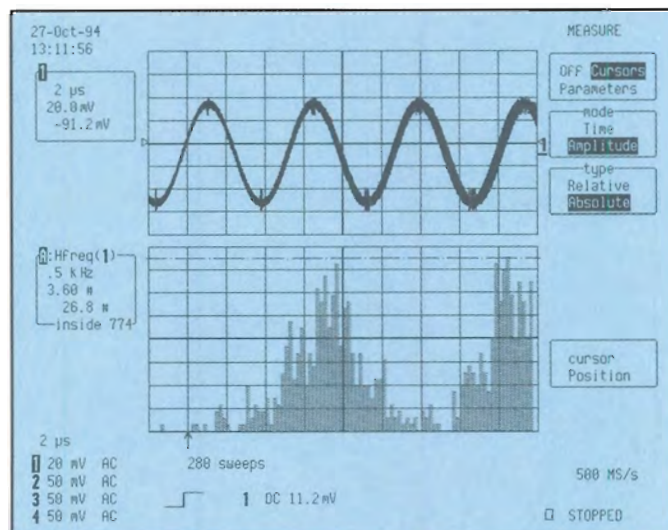

Figure 4: The top trace is a persistence display of a sinewave whose frequency is unstable. The histogram at the bottom shows that there are two components (two peaks) in the frequency distribution.

you work. When you want to show it to someone or produce a document it is all ready. This is a particularly handy tool for engineers whose supervisors spend a lot of time in meetings. Whenever the boss comes by your bench, you can replay from your hard drive the results of your work. The new hard drive is also a boon to companies where ISO 9000 is important. Test data can be archived much more quickly onto the internal hard drive in a scope than by sending it over GPIB to a computer. At the end of the day, the data from the scope can be downloaded to a master storage device.

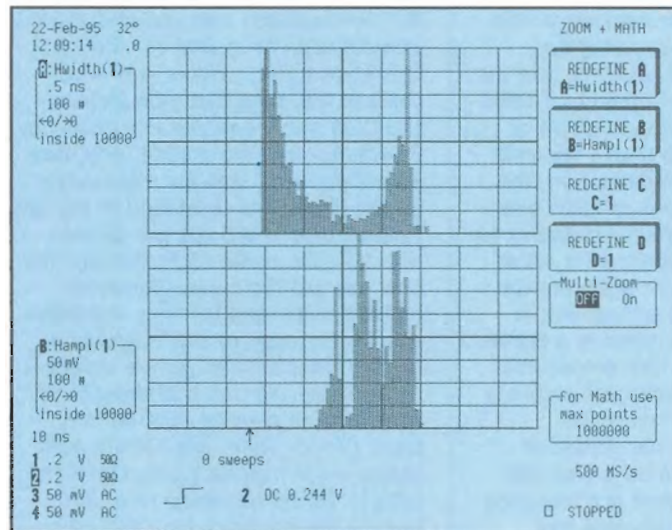

Figure 5: This figure shows an analysis of the widths (upper part of screen) and amplitude (lower half of the screen) of the bits in a data stream. Up to four histograms can be displayed simultaneously.



## Testing 155 Mbps Signals

In the last 15 years, digital switching has taken over from analog switching. In the past 2 years a new method of multiplexing, called the Synchronous Digital Hierarchy (SDH) in Europe and the Synchronous Optical Network (SONET) in North America, is gaining popularity thanks to its interconnecting flexibility and ease of management. Today, most countries are in the process of replacing the old PDH hierarchy with this new standard.

As a result, new testing requirements for these standards have also arisen. This application note shows how LeCroy High-Bandwidth oscilloscopes can be used to test the 155 Mbps electrical signals against the ITU pulse masks, thanks to their CMI triggering capability, and their bandwidth specifications.

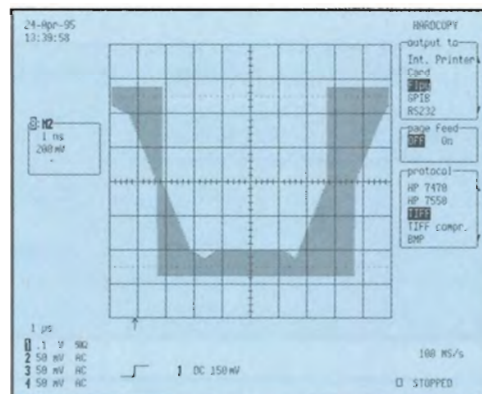
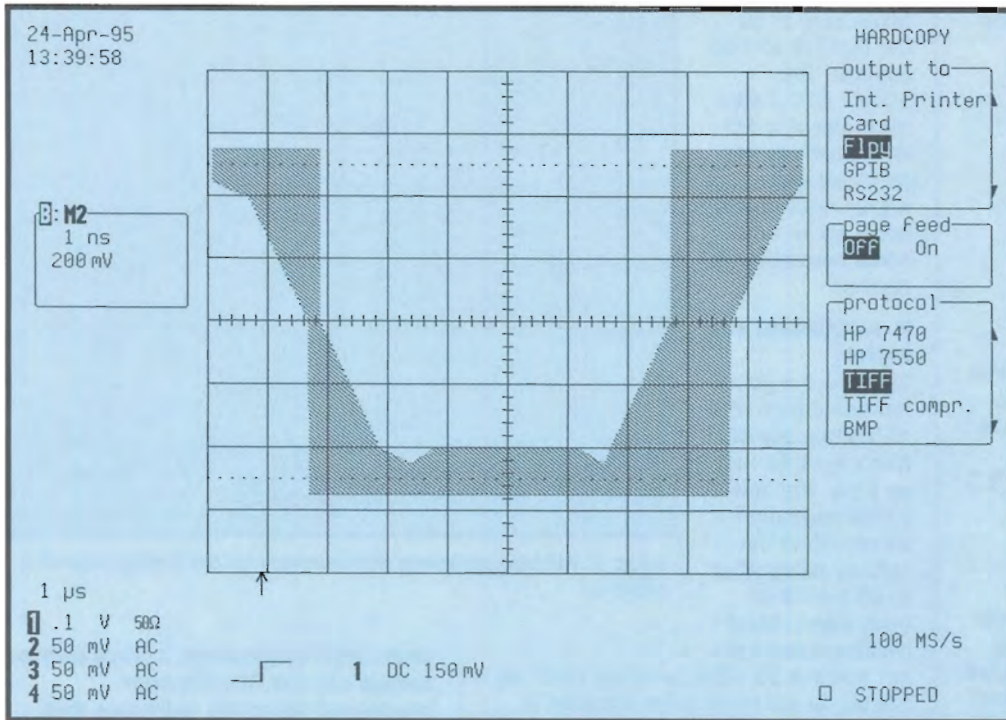

Figure 2: Binary 1 mask on a LeCroy oscilloscope

### I. WHY MASK TESTING?

Mask testing can appear unsophisticated in today's world of high-layer, protocol-level testing equipment. However, one should bear in mind that one of SDH/SONET's mission's is to "make multivendor networks manageable". One of the basic keys to inter-operability between different vendors is that their physical and electrical behavior should match as tightly as possible. Only with that condition fulfilled can a network device from one vendor be directly replaced with that of another vendor. The mask test verifies the strict compliance of a device to its electrical standards.

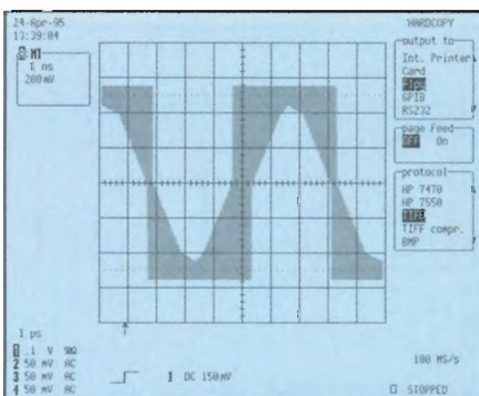

Figure 1: 155 Mbps mask of a binary 0 as seen on a LeCroy oscilloscope

### II. THE SIGNAL AND THE MASKS

Performing mask testing on the 155 Mbps, CMI encoded signal (see the "CMI encoding" callout on the next page), involves acquiring a live signal with an oscilloscope and comparing it with two different ITU (formerly CCITT) tolerance masks: the "bit 0" mask (Figure 1) and the "bit 1" mask (Figure 2).

### III. MEASUREMENT ACCURACY

To achieve confidence in the test results, two fundamental categories of errors should be evaluated:

Amplitude accuracy in a digital oscilloscope can be accounted for and is well within 2% of the instrument's full scale (for a 1 V peak-to-peak signal that is 200 mV/div x 8 divisions x 2%) = ± 32 mV.



Rise time accuracy is a function of the instrument's bandwidth and can be expressed in the following formula:

$$t_{sig} = \sqrt{t_{meas}^2 - t_{instr}^2}$$

$t_{sig}$ : signal rise time

$t_{meas}$ : measured rise time

$t_{instr}$ : instrument rise time

The table below compares the rise time errors produced by 3 different oscilloscopes, with bandwidths between 500 and 1 GHz.

Figure 3 shows a typical fall time of 1.3 ns on an STM-1E signal

#### IV. MONITORING THE SIGNAL

##### A. IMPEDANCE MATCHING

The SDH: STM1-E signal's input impedance is 75  $\Omega$ . The oscilloscope input impedance should therefore be adapted to this value to minimize distortion and the readings on the display should be accordingly scaled: this is automatically

taken care of by the ProBUS AP-082 adaptor. The SONET STS-3 electrical signal is 50 W. It matches the oscilloscope's native input impedance, so no additional correction is needed.

##### B. ACQUIRING THE SIGNAL

To achieve a good representation of a 155 Mbps signal, with edges as fast as 1 ns, the horizontal resolution should be in the 100 ps range (that is 10 points on each edge). Most oscilloscopes cannot achieve 10 GS/s in single shot so the signal will have to be acquired in repetitive "sampling" mode. Currently, the LeCroy 9362 is the only 10 GS/s

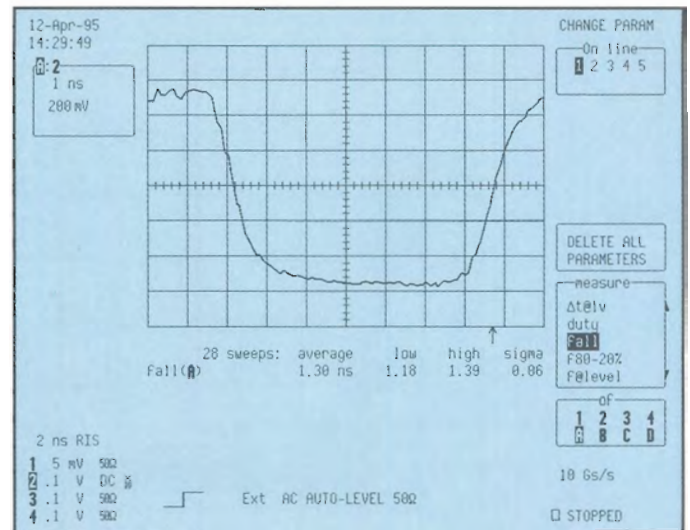

Figure 3: Fall time parameter measurement on the leading edge of a binary 1.

single shot oscilloscope. LeCroy oscilloscopes use the RIS (Random Interleaved Sampling) technique that can achieve a horizontal resolution of 50 ps.

##### C. ISOLATING THE 1S FROM THE 0S

Acquiring a signal in "sampling" mode means many events or sweeps have to be acquired by the instrument in order to construct the trace. This requires repetitive signals. A SONET/SDH electrical is CMI encoded and outputs two different patterns: a "zero" and a "one". Usually the device cannot be exercised to output "only zeroes" or "only ones" so the oscilloscopes will acquire both patterns that will overlap on the

Instrument		Signal	Reading	Reading Error
Bandwidth (MHz)	Rise Time (ns)	Rise Time (ns)	Rise Time (ns)	
500	0.7	1.5	1.66	10.35%
622	0.56	1.5	1.6	6.74%
1000	0.35	1.5	1.54	2.69%

##### CMI encoding

The CMI encoding (Coded Mark Inversion) is a two-level, non-return to zero code.

Binary 0 is coded such that both amplitude levels, A1 and A2, are attained consecutively, each for half a unit time interval ( $T/2$ ). In addition, there is always a positive transition at the mid point of the binary unit time interval.

Binary 1 is coded by either of the amplitude levels A1 or A2, for one full unit interval ( $T$ ), in such a way that the level alternates for successive binary 1s. In addition:

- There is a positive transition at the start of the binary unit time interval if in the preceding time interval the level was low (A1).
- There is a negative transition at the start of the binary unit time interval if the last binary 1 was encoded by the high (A2) level.

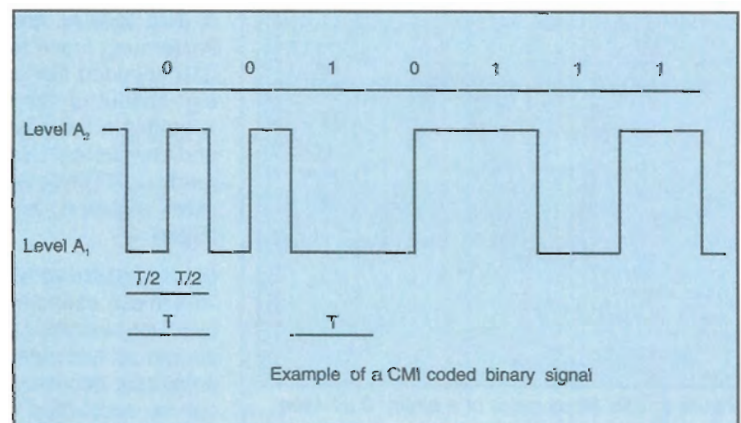

Example of a CMI coded binary signal



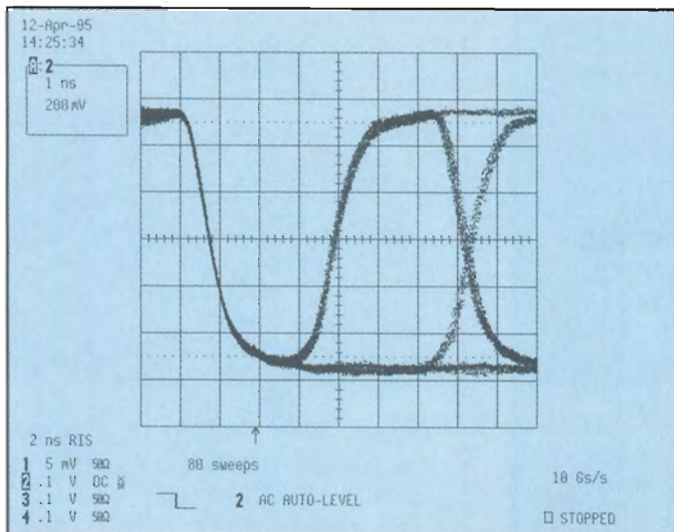

Figure 4: Overlapping patterns due to the lack of adequate triggering.

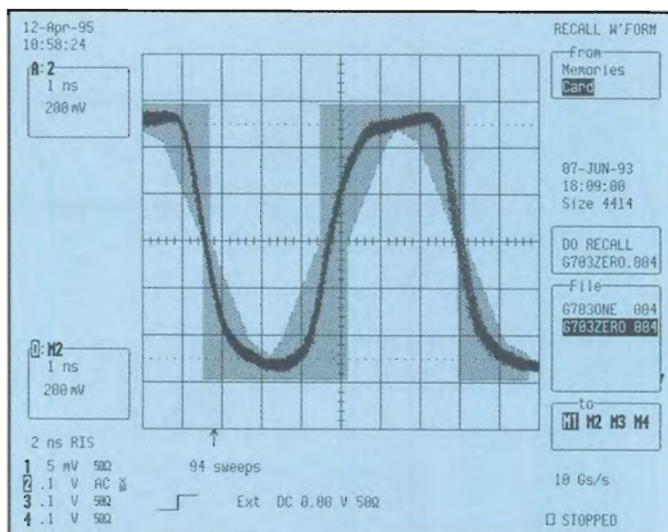

Figure 5: Mask test of a binary 0. Notice the jitter at the trailing edge of the pulse.

oscilloscope screen.

As the standard requires that each of the patterns should be tested against a different mask, the oscilloscope should provide a means of isolating the 1 bits from the 0 bits. That is precisely the purpose of the AP-082 adaptor, which selectively triggers and acquires "only 1s" or "only 0s". In each of the cases the scope will trigger on the leading edge of the pattern, as required by the ITU standard. Now the signals can conveniently be compared with their respective tolerance mask. Furthermore, a persistence display can be set up to show very effectively the amount of high frequency jitter on the trailing edge (Figures 5 and 6).

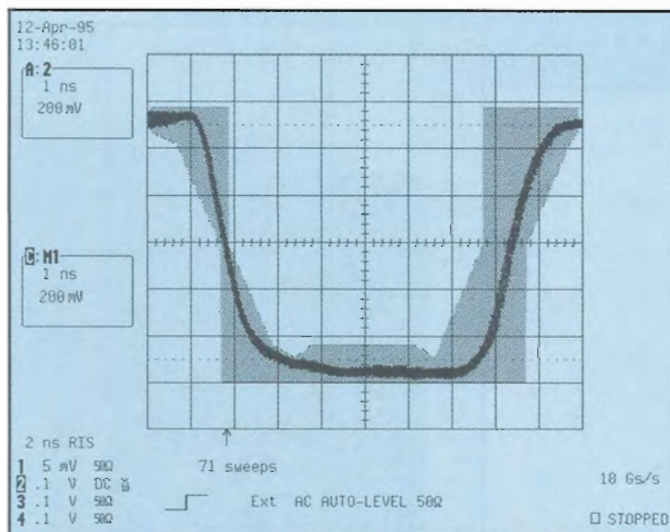
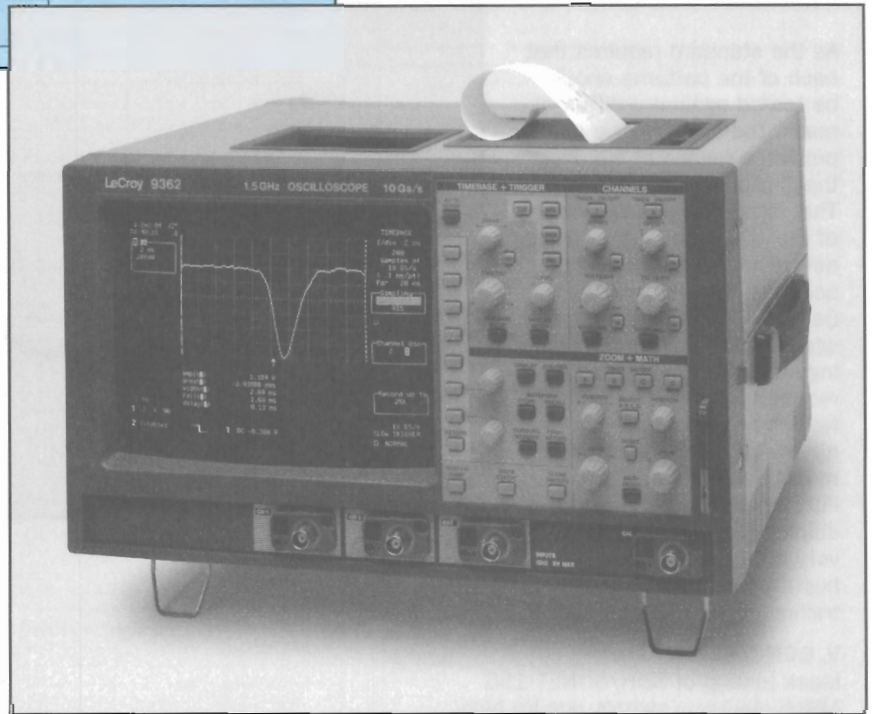
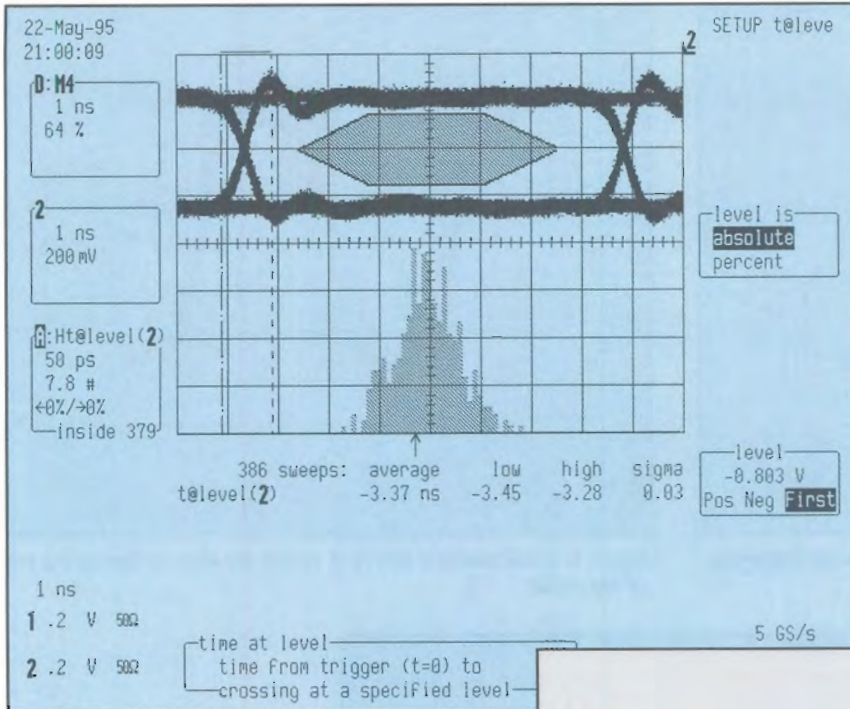

Figure 6: Mask test of a binary 1.

## V. CONCLUSION

Mask testing of SDH/SONET 155 MBps electrical signals require high bandwidth oscilloscopes to achieve appropriate accuracy. Furthermore, in the vast majority of situations, a dedicated trigger is necessary to isolate the two different bit patterns. Thanks to its range of high bandwidth oscilloscopes, and to its dedicated trigger, LeCroy offers a complete solution for this application.



LeCroy scopes can select 1's or 0's for individual testing using the AP082 and AP083 accessories described in the previous technical note, or the user can perform eye pattern testing as shown above. The dotted lines at the left side of the screen define an area of interest. The bar chart on the lower part of the screen is a histogram of the time of arrival of all the leading edges of the pulses. The model 9362 is the only digital scope that can capture such data at up to 10 GS/s single shot.



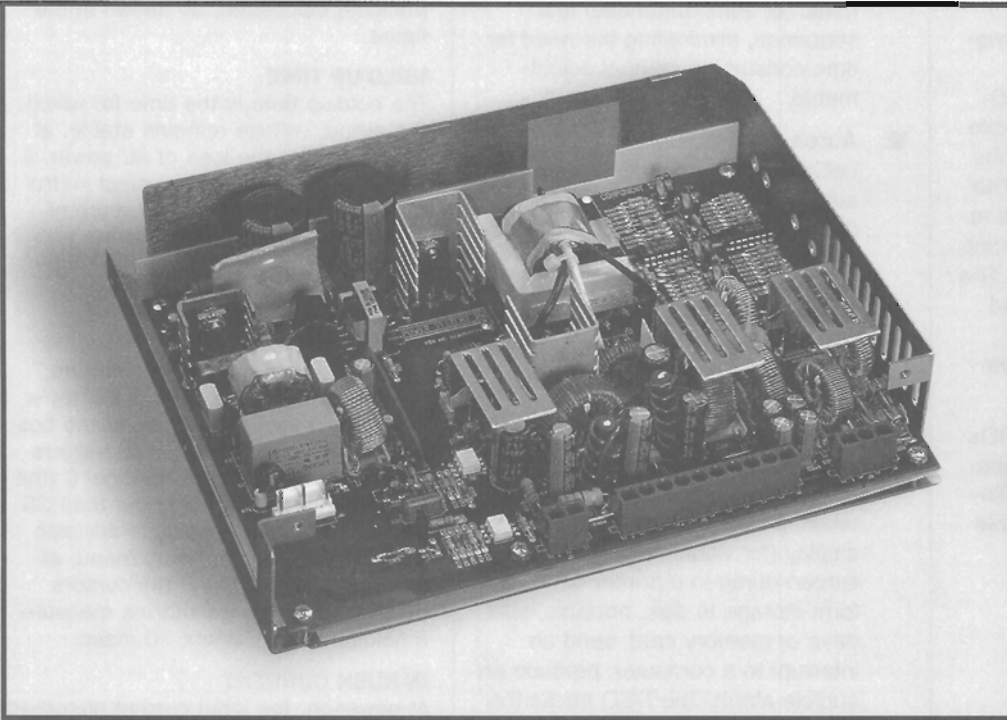

## Introduction

The last decade has seen dramatic improvements in power supplies, and particularly in switch-mode power supplies. Due to improvements in power MOSFETs, in regulators and in control circuitry, switching power supplies are becoming smaller with power densities already greater than one watt per cubic inch, and with efficiencies reaching 90%.

As with many other technologies, the product life cycle is shortening rapidly, and manufacturer competition is becoming tougher. When the designs are very similar, a shorter time-to-market (for a new product), or a shorter production cycle, can make the winning difference. Test time, for instance, can now be reduced by using the latest developments in digital oscilloscopes. In the following we will describe a number of applications where digital oscilloscopes can considerably shorten design and test times.

### BENEFITS OF DSOS

As with analog oscilloscopes, the primary job of a digital oscilloscope is to display the input waveforms. Unlike analog oscilloscopes, the technique used to achieve this is to sample the input waveforms at regular intervals. The sampled analog values are

then converted into digital numbers which in turn are stored into an internal memory. An input waveform is stored in the scope as a sequence of numbers, as many as the memory length. The waveform display is done by retrieving these numbers and representing them on the screen.

The use of this digital technology has many implications. Those which affect power supply testing include the following:

- **Multi-channel single-shot capture:** A DSO can capture single shot phenomena like power ON/OFF or failure conditions synchronously on up to four channels at the same time.
- **Waveform processing:** Since the DSO internally uses a microprocessor, it can also perform various types of processing on the acquired waveform.

For example, automatic calculation of pulse parameters and basic waveform mathematics (sum, difference, product, ratio) are standard features of all LeCroy oscilloscopes. Options are available for the 9300 series scopes to perform more complex mathematics like integral, derivative, exponential, logarithm, extended averaging, digital filtering, extreme values, Fast Fourier Transform and more.

## Benefits of Digital Oscilloscopes in Power Supply Design & Test

This technical note focuses on the uses of digital scopes for measuring power supply characteristics. Examples are given of measuring power supply turn-on, hold-up time when AC power fails, in rush current and ripple/noise. Examples are given of pass/fail testing and power calculation. There is also a brief discussion of triggering and of the possibility of storing test sequences.



- Data storage and archiving:** LeCroy DSOs have built-in memories which can store reference waveforms. They also offer DOS-compatible memory card, portable hard drive and floppy-disk options for non-volatile mass storage. The scopes can be easily interfaced to a large variety of plotters and printers for high quality hardcopies. The user can download the data and screen graphics as TIFF files directly into WordPerfect or other publishing software.
- More trigger possibilities:** DSOs also offer a wealth of trigger capabilities not found in analog oscilloscopes. For instance it is possible to trigger on faulty conditions and look at pre-trigger data to understand the history leading to the fault.
- Stored test sequences:** All LeCroy oscilloscopes offer the facility to store entire instrument setups in internal non-volatile memories. Many more setups can be stored onto memory cards, portable hard drive, or floppy disks, depending on what mass storage option is installed. These setups can be easily recalled either manually or under computer control. The user can then recall these predefined setups as part of a fully auto-

matic (or semi-automatic) test sequence, eliminating the need for time consuming manual adjustments.

- Automatic PASS/FAIL testing:** LeCroy DSOs provide two kinds of automatic testing. The user can define a mask waveform and specify that any input waveform must be contained within the mask. Alternatively, the user can select a set of waveform parameters, which will be automatically calculated, and compare them to predetermined limits. If the waveform or the parameters fall outside the desired limits, a number of actions can be taken, including: freezing of the display (for visual inspection); screen-dump to a printer or waveform storage to disk, portable hard drive or memory card; send an interrupt to a computer; produce an audible alarm. The DSO tracks the statistics of passing and failing events.

#### MONITORING AT POWER-ON

Figure 1 shows the Power-On transitions in a multi-voltage power supply. The simultaneous monitoring of all these transitions is useful to verify that any phase shifts are within acceptable limits. In fact, any voltage imbalances could be damaging to the load circuits. The switching time can also be auto-

matically calculated, as shown in the figure.

#### HOLD-UP TIME

The hold-up time is the time for which the output voltage remains stable, at full load, after the loss of AC power. A digital oscilloscope is the ideal instrument for measuring this because of both the powerful trigger system and the single shot capture capability. (An oscilloscope with deep memory is normally required.)

Figure 2 shows such a hold-up time. The trigger condition used is LeCroy's "Dropout" trigger. As shown at the bottom of the display, the scope triggers when the pulse train on channel C (the AC line) disappears for longer than 25 msec. The trigger conditions are also shown on the trigger setup menu, at the right of the display. The cursors positioned on the waveforms measure a hold-up time of about 70 msec.

#### IN-RUSH CURRENT

At power-on, the input current absorbed by the power supply has a spike which should not exceed the maximum allowable input current. The upper trace in Figure 3 shows an example of In-Rush current. The lower trace shows the simultaneously acquired input voltage.

The oscilloscope used, a Model 9314AM, utilizes a bi-slope trigger, as shown in the trigger icon, at the bottom of the screen. That is, the oscilloscope would trigger on Channel 1 for whatever

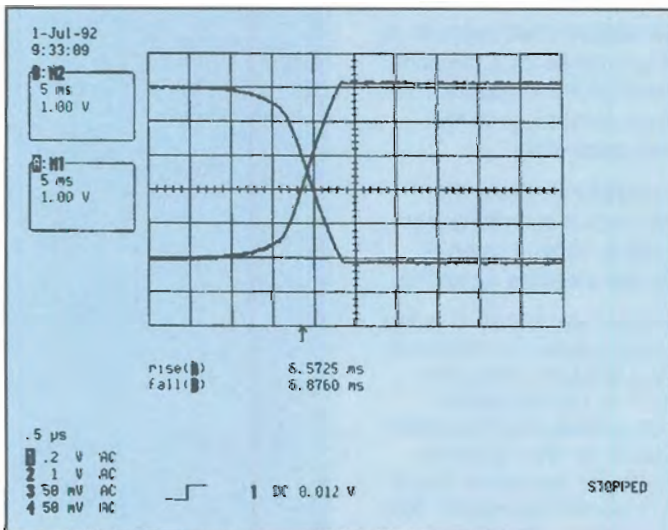

Figure 1: Switch-on transition of a dual output power supply (+5 V and -5 V). Symmetric behavior of the two voltages is often required. The automatic calculation of pulse parameters (rise and fall times in this case) simplify this test.

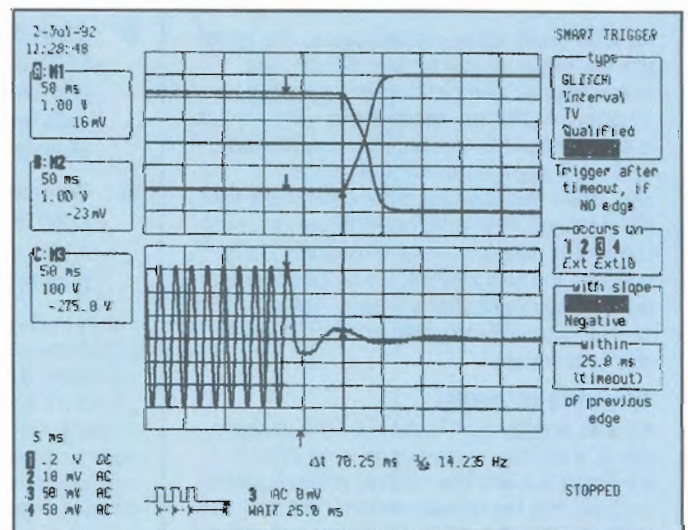

Figure 2: Measurement of the hold-up time. LeCroy's "Dropout" trigger mode is used, causing the scope to trigger on the mains drop which occur at the left of the lower trace.



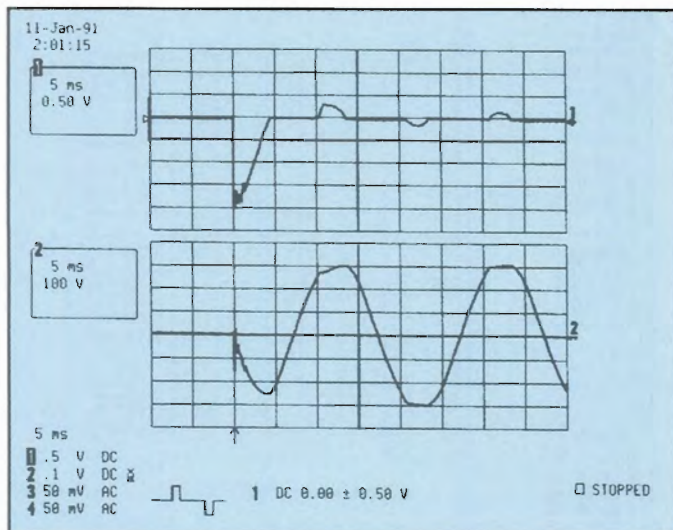

Figure 3: The in-rush current of a switching power supply (upper trace) is shown together with the input voltage. LeCroy's "Bi-slope" trigger is used to trigger on current transitions of any slope.

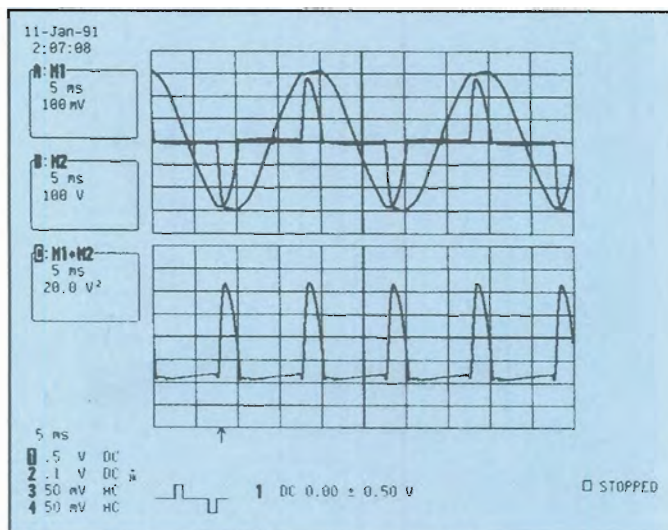

Figure 4: The power supply input voltage and input current (upper traces) are multiplied to provide the input power (lower trace).

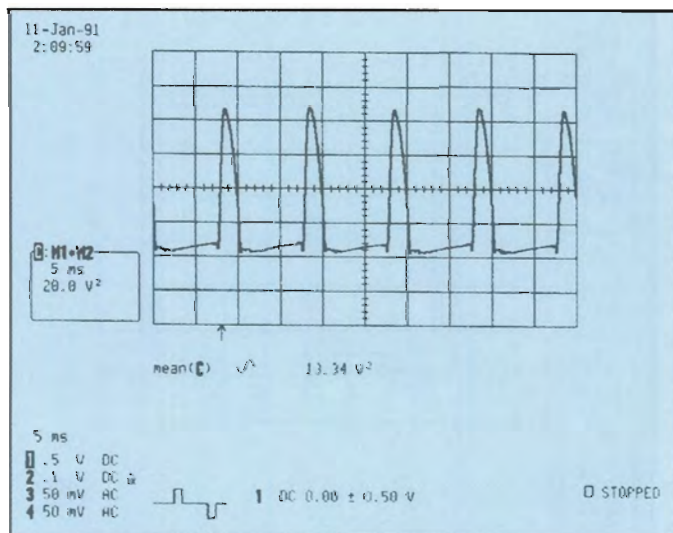

Figure 5: The same power waveform as in Figure 4, has been used to automatically calculate the mean value of the power.

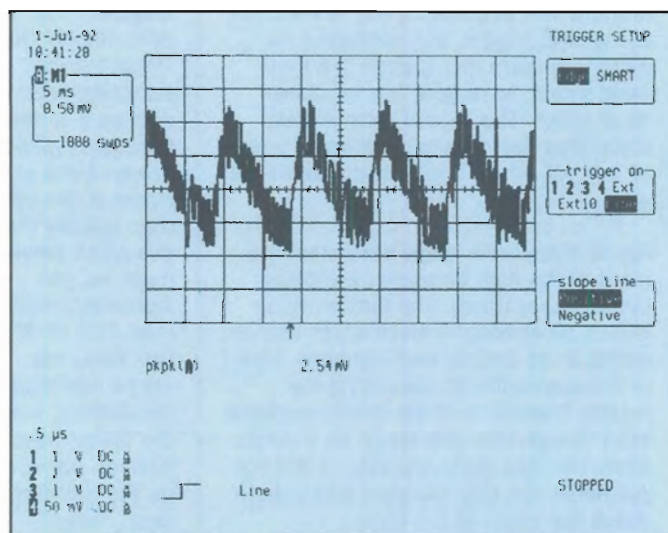

Figure 6: The output ripple is measured by averaging 1,000 acquisitions using "Line" trigger. A peak-to-peak voltage of 2.5 mV is automatically measured.

slope of the input pulse, provided it exceeds +0.5 V. The oscilloscope can test the In-Rush current automatically and in two different ways. It can calculate the current peak value and verify that it is smaller than a preset limit.

Alternatively it can compare the full current waveform with a reference mask (as required by the European Telecommunication Draft Standard pr ETS 300 132). If the test fails, that is,

if the in-rush current exceeds the set limits, several actions can be taken.

### POWER CALCULATION

The oscilloscope can be used to compute power. This is shown in Figure 4 where the two upper waveforms are respectively voltage and current at the input of a power supply. These two waveforms are multiplied point-by-point to provide the power waveform at the bottom.

Figure 5 shows again the same power waveform together with the mean value of the power automatically calculated below the grid. The ratio of the output power (a DC value) to the mean value of the input power, would provide the power supply efficiency.

### RIPPLE AND NOISE

Figure 6 shows an example of ripple measurement, (i.e., a measurement of the remaining AC component on the



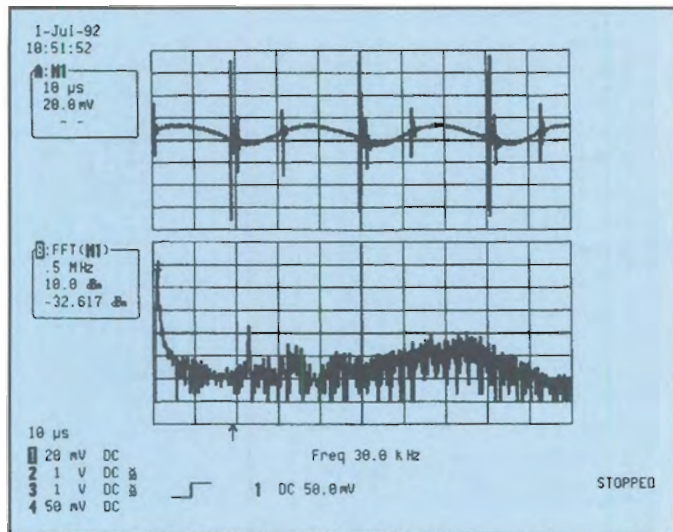

Figure 7: The high frequency noise induced by the power switching. The Fast Fourier Transform (lower trace) shows frequency components at much higher frequency than the switching frequency indicated by the cursor (30 kHz).

output). The displayed trace is obtained using LINE trigger, and averaging the input waveform on Channel 1 a thousand times, to remove the asynchronous noise. The scope automatically calculates the peak-to-peak ripple value of 2.5 mV, which is displayed below the grid.

Figure 7 shows a single-shot measurement of the high frequency switching noise (upper trace). The bottom trace shows an optional feature which can be added to all LeCroy oscilloscopes, that is the possibility of calculating the Fourier Transform of the input waveform even though this was taken as a single shot. The frequency analysis of the output noise can give valuable information about the origin of the noise.

#### SAFE OPERATING AREA

In a switching power supply the switching transistor(s) is probably the most stressed component and it is often important to verify that its working points lie inside the Safe Operating Area. The upper trace in Figure 8 shows the collector-to-emitter voltage of a switching transistor, while the middle trace is the emitter current. The bottom trace is the product of the previous two traces and it shows therefore the power dissipated inside the transistor. The two horizontal cursor lines show the limits imposed by the Safe Operating Area.

#### AUTOMATIC PASS/FAIL TESTING

The Safe Operating Area test just described can also be done completely

automatically. The user selects the "Peak-to-Peak" parameter and applies it to the third (dissipated power) trace of Figure 8. He can then specify that this pk-pk power must be, for instance, smaller than 400 V<sup>2</sup>. If the test fails, the scope can stop the acquisition, store the failing waveform on paper or on the memory card, "beep" and/or send an interrupt to the computer.

Another approach to the automatic test is shown in Figure 9.

The two outer traces shown constitute a Test Mask for the Pulse Width Modulated waveform on the collector of the switching transistor. They represent the maximum excursions that the upper trace in Figure 8 is allowed to have. (This mask may be generated automatically inside the scope. The user simply takes an acquired waveform and then specifies the desired tolerances.) When the test is activated, the scope will veri-

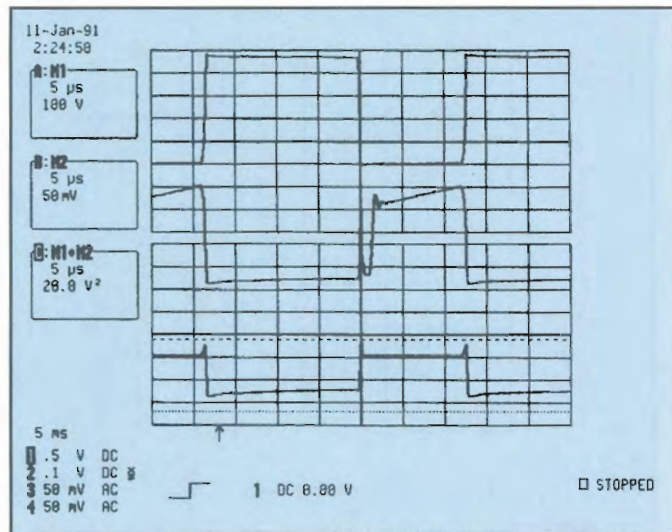

Figure 8: Voltage and current across the switching element. The product of the two gives the power waveform at the bottom. The oscilloscope can perform a PASS/FAIL test on the peak power, alerting the operator when violations of the Safe Operating Area are found.

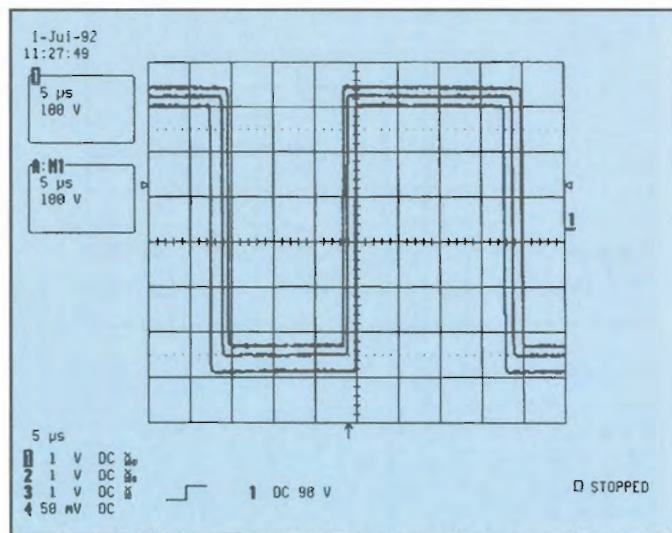

Figure 9: Automatic PASS/FAIL test on the PWM waveform. The scope automatically tests that any input signal (inner waveform) lies inside the two outer waveforms (reference mask). Actions can be taken in case of failure.

fy that all input waveforms fall inside the mask. In case of failure, the same actions mentioned previously can be taken.



LeCroy personnel have a strong commitment to exemplary support of our customers. Our aim is to provide timely and thorough responses to your questions and requests, whether prior to ordering or after taking delivery. Registering your LeCroy product will further ensure that you are kept up to date on product line enhancements, general updates, and new offers. Be sure to fill out and send in the Product Registration Card found in all shipments of new products.

### FREE PRODUCT ASSISTANCE

Answers to questions concerning installation, calibration, and use of LeCroy equipment are available from your local field office (see pages 182 and 183 for the office nearest you) or from our Customer Care Center, 700 Chestnut Ridge Road, Chestnut Ridge, New York 10977-6499. Calling 800-553-2769 (in the USA) will vector you to the correct party.

### IN THE USA

Sales, Technical Assistance and General Information

**1-800-5-LeCroy  
(1-800-553-2769)**

### LECROY SALES & SERVICE

LeCroy sales engineers are experts in the field of measurement. Many of them have a BSEE, Masters degree or doctorate in addition to several years experience in solving measurement problems. Customers find that the advice of a LeCroy sales engineer allows them to find the instrument most ideally suited to their application. The result is better quality work, shorter time to market for new designs, higher manufacturing throughput and lower costs for equipment. While other companies are changing to distribution outlets that give a lower level of customer support, LeCroy is expanding its sales service to customers.

### TEST DRIVES

Some instrument users prefer to "test drive" a product prior to purchase. A few days using the instrument at their own bench with typical signals gives the customer excellent insight into whether the product is right for them. This can be especially true for people who are converting from older style analog scopes to digital oscilloscopes or for those who want to compare a more powerful scope with an older digital scope to see if they can do their job better. LeCroy can often arrange for a "test drive" by having a salesperson drop off the instrument and give a

brief tutorial on its use. You can arrange a test drive in the USA by calling 1-800-5-LeCroy (1-800-553-2769).

### THE BULLETIN BOARD

LeCroy's electronic bulletin board allows customers to download utility programs, send their programs to LeCroy, send samples of interesting data or receive customized programs from the factory. Popular programs include interface routines for GPIB and RS-232, basic graphing to draw the data on PCs and other utilities. Customers should call the LeCroy Customer Care Center (1-800-5-LeCroy) if they want to send data or programs to the factory for analysis. The phone number for the bulletin board is 914-578-6090.

### REPAIR SERVICE

The typical turnaround time to repair a LeCroy portable DSO at any LeCroy service office is 7 days. In the USA you should obtain a Return Authorization number by calling 1-914-578-6020 prior to sending in the item. This will speed processing when your unit arrives at LeCroy's service office. LeCroy has standard prices for repair of its products after expiration of the warranty. The standard prices allow for quick and easy paperwork. A customer can usually know the price of a repair before it is sent in for work. LeCroy runs a complete calibration check on every item received for repair or upgrade. Copies of test data and calibration certificates are available at a nominal fee.

### SERVICE IN THE USA

Call 1-800-5LeCroy  
(1-800-553-2769)

### LeCroy Corporate Headquarters

USA  
700 Chestnut Ridge Road  
Chestnut Ridge, NY 10977-6499

### Customer Care Center

Tel: (914) 578-6020  
FAX: (914) 578-5985

### LECROY INTERNATIONAL SERVICE OFFICES

#### France

LeCroy SARL  
1 69 18 83 20 - Les Ulis (Paris)

#### Germany

LeCroy GmbH  
(06221) 831001 - Heidelberg

#### Italy

LeCroy Srl  
(06) 33 67 97 00 - Rome

#### Japan

LeCroy Japan  
(06) 330 0961 - Osaka  
(03) 3376 9400 - Tokyo

#### Netherlands

LeCroy b.v.  
(04902) 89285 - Valkenswaard

#### Switzerland

LeCroy SA  
(022) 719 21 11 - Geneva

#### United Kingdom

LeCroy Ltd  
(0235) 533114 - Abingdon

### LeCroy European Manufacturing

#### LeCroy SA

2, rue du Pre-de-la-Fontaine  
PO Box 341  
CH-1217 Meyrin 1 Geneva  
Switzerland  
Tel: (022) 719 21 11  
FAX: (022) 782 39 15

### UPGRADES

A substantial benefit of owning LeCroy equipment is the availability of free upgrades to the operating system during the warranty period. If LeCroy improves the performance of a product those improvements can often be passed on to previous customers by installing new software or firmware in their units. In some cases, features such as floppy disk drives, built-in printers, spectrum analysis software or other new features can be added at a reasonable cost. LeCroy always endeavors to make new features retrofittable into previous designs. This protects your investment against obsolescence.

LeCroy even offers the capability to upgrade the acquisition memory in most oscilloscopes. This very important upgrade path is not available from other companies.

### CALIBRATION

LeCroy recommends annual verification of the calibration for all its instruments. You can arrange for calibration from local LeCroy field service offices anywhere in the world, from our factory headquarters in NY or from our European headquarters in Switzerland. LeCroy will check the calibration of any instrument under warranty once per year at no charge. Customers who require copies of test data and trace-

able certificates for NIST, ISO 9000 or MIL-STD 45662A quality standards may obtain those documents for a reasonable service fee. Calibrations performed according to LeCroy standards are substantially more rigorous than those performed by the test systems of other vendors or by "calibration houses". For example, few users of oscilloscopes use them to measure DC voltages but most oscilloscope calibration systems only verify DC accuracy. LeCroy's calibration checks the accuracy of the scope using sine waves of various frequencies and amplitudes. LeCroy tests include trigger modes, probe calibrator accuracy, ground line accuracy, pulse response, GPIB data transmission and a variety of other tests in addition to the usual bandwidth, DC accuracy and timebase verification.

#### **EXTENDED MAINTENANCE CONTRACTS**

LeCroy makes it easy for customers to provide for future service of their instruments by offering optional five year repair warranty, five year calibration contracts or five year total coverage which includes repair and calibration. These services make future support of the instrument easy. No P.O. is needed for future repair or calibration, the customer doesn't have to worry about budgeting money for maintenance and the lifetime cost of the instrument (which is often depreciated over five years) can be set in one lump sum.

#### **ON SITE SERVICE**

Most LeCroy service is performed at regional service offices. However, some customers have special requirements for on site service. This can be arranged either through an advance contract for Supplemental Support or through on-call service. A Supplemental Support arrangement covers 32 hours of on-site time by a LeCroy technician for repairs, upgrades, calibration, installation, training or any other service desired by the customer. It also covers travel time and travel costs. LeCroy on-call service bills the customer for the expenses involved with each individual service trip.

#### **WARRANTY**

LeCroy warrants its digital oscilloscopes to operate within specifications under normal use and service for a period of two years from the date of shipment. 9200 series pulse generators are warranted for five years and all other instruments for one year. Component products, replacement parts, and

repairs are warranted for 90 days.

This warranty extends only to the original purchaser. Software is thoroughly tested, but is supplied "as is" with no warranty of any kind covering detailed performance. Accessory products not manufactured by LeCroy are covered by the original equipment manufacturer's warranty only.

In exercising this warranty, LeCroy will repair or, at its option, replace any product returned to the factory or an authorized service facility within the warranty period, provided that the warrantor's examination discloses that the product is defective due to workmanship or materials and has not been caused by misuse, neglect, accident or abnormal conditions or operations.

The purchaser is responsible for the transportation and insurance charges arising from the return of products to the servicing facility. LeCroy will return all in-warranty products with transportation prepaid.

This warranty is in lieu of all other warranties, express or implied, including but not limited to any implied warranty of merchantability, fitness, or adequacy for any particular purpose or use. LeCroy will not be liable for any special, incidental, or consequential damages, whether in contract, or otherwise.

#### **SOFTWARE LICENSING AGREEMENT**

Software products are licensed for a single machine. Under this license you may:

- Copy the software for backup or modification purposes in support of your use of the software on a single machine.
- Modify the software and/or merge it into another program for your use on a single machine.
- Transfer the software and the license to another party if the other party accepts the terms of this agreement and you relinquish all copies, whether in printed or machine-readable form, including all modified or merged versions.

#### **UNPACKING AND INSPECTION**

LeCroy recommends that the shipment be thoroughly inspected immediately upon delivery. All material in the container(s) should be checked against the enclosed Packing List and shortages reported to the carrier promptly. If the shipment is damaged in any way, please notify the carrier. If the damage is due to mishandling during shipment, you must file a damage claim with the carrier. The LeCroy field service office can help with this. LeCroy tests all products before shipping and packages all products in containers designed to protect against reasonable shock and vibration.

#### **SERVICE PROCEDURE**

Products requiring maintenance should be returned to the factory or authorized service facility. If under warranty, LeCroy will repair or replace the product at no charge. The purchaser is only responsible for the transportation charges arising from return of the goods to the service facility.

For all LeCroy products in need of repair after the warranty period, the customer must provide a Purchase Order Number before any inoperative equipment can be repaired or replaced. The customer will be billed for the parts and labor for the repair as well as for shipping.

#### **RETURNS**

All products returned for repair should be identified by the model and serial numbers and include a description of the defect or failure, name and phone number of the user. In the case of products returned, a Return Authorization Number is required and may be obtained by contacting the Service Office in your area. Any returned goods should be shipped in the original packaging material. Returned goods that have not been packed in the original packing material and have been damaged in shipping will not be repaired under warranty. Any goods returned for credit are subject to a 20% restocking charge.



# Customer Feedback Form

One of the major reasons for LeCroy's success is that we listen to our customers. If you have an idea about how to improve a current LeCroy product or about a new option, product or service we should offer in the future, please fill out the form below and send it to us. We may not be able to act on your idea right away, but you can be assured that your input goes directly to the top marketing and engineering managers. Please feel free to include any applicable documents showing what type of measurement, software calculation, trigger condition, etc. you are working with.

Name \_\_\_\_\_  
Title \_\_\_\_\_  
Address \_\_\_\_\_  
City \_\_\_\_\_  
State \_\_\_\_\_  
Zip \_\_\_\_\_  
Phone #: \_\_\_\_\_  
FAX #: \_\_\_\_\_  
E-Mail Address: \_\_\_\_\_

My Idea to improve LeCroy Test Instruments is:

Instrument Model #: \_\_\_\_\_

Idea: \_\_\_\_\_  
\_\_\_\_\_  
\_\_\_\_\_  
\_\_\_\_\_

Please FAX this form to either the LeCroy Corporate Headquarters in New York at (914) 578-5985 or to the European Headquarters in Heidelberg, Germany at (06221) 83 46 55

**United States**

**Direct Sales Representation  
Throughout the United States**

**For Sales, Technical Support, Repair or  
Calibration, Call**

**1-800-5-LeCroy  
(1-800-553-2769)**

**LeCroy International****AUSTRALIA**

Sales Headquarters  
Eastern Hemisphere  
LeCroy Pty. Ltd  
17 Loddon Street  
Box Hill North 3129  
Victoria  
Phone: (03) 9890 7358  
FAX: (03) 9890 8754

**FRANCE**

LeCroy SARL  
Les Conquerants  
Immeuble Fuji-Yama  
1, avenue de l'At antique  
L.P. 903 - Les Ulis  
F-91976 Courtaboeuf Cedex  
Phone: (1) 69 18 83 20  
FAX: (1) 69 07 40 42

**GERMANY**

LeCroy GmbH  
Mannheimer Str 175  
D-69123 Heidelberg  
Phone: (06221) 83 10 01  
FAX: (06221) 83 46 55

**ITALY**

LeCroy srl  
Via Concesio 325  
I-00188 Roma  
Phone: (06) 33 67 97 00  
FAX: (06) 33 67 96 00

**JAPAN**

LeCroy Japan Corporation  
Esaka Sansho Bldg - 3rd Floor  
16-3, 3-Chome  
Tarumicho, Suita City  
Osaka 564  
Phone: (06) 330 0961  
FAX: (06) 330 8096

LeCroy Japan Corporation  
Sasazuka Center Bldg 6th Floor  
1-6, 2-Chome, Sasazuka, Shibuya-ku  
Tokyo 151  
Phone: (03) 3376 9400  
FAX: (03) 3376 9587

**NETHERLANDS**

LeCroy b.v.  
Waalreweg 17  
NL-5554 HA Valkenswaard  
Phone: (04902) 89285  
FAX: (04902) 42628

**SWITZERLAND**

LeCroy SA  
2, rue du Pré-de-la-Fontaine, P.O. Box  
341  
CH-1217 Meyrin 1 Geneva  
Phone: (022) 719.21 11  
FAX: (022) 782.39.15

LeCroy SA  
Bahnhofstrasse 18  
CH-5600 Lenzburg  
Phone: (064) 519 181  
FAX: (064) 519 192

**UNITED KINGDOM**

LeCroy Ltd  
28 Blacklands Way  
Abingdon Business Park  
Abingdon, Oxon OX14 1DY  
Phone: (0235) 533114  
FAX: (0235) 528796



## Representing LeCroy Worldwide

### CANADA

#### EASTERN REGION

Allan Crawford Associates Ltd  
5835 Coopers Ave  
Mississauga, Ontario L4Z 1Y2  
Phone: (905) 890-2010  
FAX: (905) 890-1959

#### WESTERN REGION

Allan Crawford Associates Ltd  
410-212 Brooksbank Ave  
North Vancouver, BC V7J 2C1  
Phone: (604) 878-1006  
FAX: (604) 980-5892

### ARGENTINA

Search SA  
Viamonte 1716 - Piso 7  
Oficinas 32 y 33  
1055 Buenos Aires  
Phone: (01) 375 1435  
FAX: (01) 803 2505

### AUSTRALIA

Local Sales  
Scientific Devices  
Australia Pty. Ltd.  
2 Jacks Road  
South Oakleigh, Victoria 3167  
Phone: (03) 579 3622  
FAX: (03) 579 0971

### AUSTRIA

Dewetron Elektronische Messgeraete  
GesmbH  
Foellingerstrasse 9E  
A-8044 Graz  
Phone: (316) 391804  
FAX: (316) 391052

### BRAZIL

ATP-Hi-Tek Electronica Ltda  
Alameda Amazonas  
422 - Alphaville  
06454-070 Baruei SP  
Phone: (011) 725-5822  
FAX: (011) 421 5032

### CHILE

Sistemas de  
Instrumentacion Ltda  
Concha y Toro N° 65  
STGO - Centro  
Casilla 51888 STGO-1  
Santiago 158  
Phone: (02) 6951137  
FAX: (02) 6969665

### DENMARK

Lutronic ApS  
Naverland 2  
DK-2600 Glostrup  
Phone: (43) 42.97.64  
FAX: (43) 42.97.65

### EASTERN EUROPE

Elsinco GmbH  
Breitenfurter Str 13  
A-1120 Vienna Austria  
Phone: (1) 815 0400  
FAX: (1) 815 0700

### FINLAND

Orbis OY  
PO Box 15  
SF - 00421 Helsinki  
Phone: (90) 566 4066  
FAX: (90) 531 604

### GREECE

IFIPCO - John Fourniadis & Co.  
213-215 Mesoglion Ave  
GR-11510 Athens  
Phone: (1) 6725 970  
FAX: (1) 6476 331

### HONG KONG/PRC

Schmidt Electronics  
8/Fl., Great Eagle Centre  
23 Harbour Road  
GPO Box 297  
Wanchai Hong Kong  
Phone: 2 507 0222  
FAX: 2 827 5656

### INDIA

Tata-Honeywell Ltd  
55-A/8 & 9 Hadapsar Ind. Estate  
Pune 411 013  
Phone: (021) 2 675532  
FAX: (021) 2 672205

### INDONESIA

P.T. DWI Tunggal Jaya Sakti  
Multika Building  
3rd Floor - Suite 304  
Jl. Mampang Prapatan Raya  
No. 71-72  
Jakarta 12790  
Indonesia  
Phone: (021) 797 5194  
FAX: (021) 797 5186

### ISRAEL

Ammo Engineering Ltd  
9 Harugei Malkhut St  
PO Box 13132  
Ramat Hachayal  
Tel Aviv 61131  
Phone: (03) 647 8740  
FAX: (03) 647 8771

### KOREA

Woojoo Hi-Tech Corporation  
Sinkwang Building 5F  
160-8 Karak 2-Dong  
Songpa-Ku  
Seoul 138 162  
Phone: (2) 449.5472  
FAX: (2) 449.5475

### MEXICO

Electroingenieria de Precision, SA  
Uxmal No. 520  
Col. Vértiz Narrate  
03600 México, DF  
Phone: (5) 559 7677  
FAX: (5) 575-3381

### NEW ZEALAND

E. C. Gough, Ltd.  
245 St. Asaph Street  
P.O. Box 22073  
Christchurch  
Phone: (03) 3798740  
FAX: (03) 3796776

### NORWAY

Avantec A/S  
Rosenholmveien 20  
N-1252 Oslo  
Phone: (22) 61 10 90  
FAX: (22) 61 07 59

### PAKISTAN

Electro Tech Corporation Ltd  
1st Floor, 16 Kazi Court  
Bhadurshah Zafar Road  
Karachi-74800  
Phone: (021) 493 9593  
FAX: (021) 493-7749

### PORTUGAL

M.T. Brandao, Lda  
Rua do Quanza, 150  
4000 Porto  
Phone: (02) 830 2709  
FAX: (02) 830 2710

### SINGAPORE

Abex Engineering Pte Ltd  
37 Kallang Pudding Road #08-08  
Tong Lee Building, Block B  
Singapore 1334  
Phone: 841 2818  
FAX: 841 5988

### SOUTH AFRICA

Westplex Test and  
Measurement (Pty) Ltd.  
PO Box 1765  
2nd Floor, West Block  
367 Oak Avenue  
Randburg 2194  
Republic of South Africa  
Phone: (011) 787.0473  
FAX: (011) 787.0237

### SPAIN

ESSA, Equipos y Sistemas SA  
Apolonio Morales 13 - B  
E-28036 Madrid  
Phone: (1) 359 0088  
FAX: (1) 359 0298

### SWEDEN

Measurement Systems  
Scandinavia AB  
Foretagsallen 14  
S-184 84 Akersberga  
Phone: (08) 540 829 50  
FAX: (08) 540 665 36

### TAIWAN

LeColn Technology Co. Ltd.  
4F-1, No. 214, Sec. 1  
Ho-Ping East Road  
Taipei  
Phone: (02) 365-0612  
FAX: (02) 367-1792

### THAILAND

Measuretronix Ltd  
2102/31 Ramkamhang Road  
Bangkok 10240  
Phone: (02) 3752733  
FAX: (02) 374 9965

# Terms & Conditions

## REQUESTS FOR QUOTATIONS AND TECHNICAL INFORMATION

LeCroy's worldwide network of offices and technical sales engineers will assist you in specifying, ordering, installing and operating LeCroy equipment. Please refer to the Sales and Service Office listing on Page 182 & 183 for the one nearest you.

## PRICING

Export prices are available from our worldwide sales offices. Prices in the U.S.A. can be obtained by calling 1-800-5-LeCroy.

## HOW TO ORDER

When placing an order, please specify the model number as well as the name of the instrument. Many model numbers include letter designations such as the 93XXWP01 or the OC9003. Some models are offered with several options designated by a slash followed by a number such as P9010/2. Special care should be taken to include these alphanumeric designations on your order.

## MINIMUM ORDER

All purchase orders are subject to a \$100 minimum value for U.S.A. products and SFR 200 - for Swiss products.

**U.S. Government Sales:** Most products listed in this catalog are on G.S.A. Federal Supply Schedule Contract. Prices are available upon request.

## WHERE TO ORDER AND CURRENCY

Purchase orders may be forwarded to your local sales office or directly to the manufacturing facility producing the product you desire. Your local currency may be used for orders placed with direct LeCroy subsidiaries or sales representatives. A list of all the sales offices and representatives is given on the previous two pages.

Rental company orders within the U.S.A. should be called in directly to Corporate Headquarters in New York at (914) 578-6020.

## ACKNOWLEDGMENT

When a purchase order is accepted by LeCroy Corporation, an acknowledgment is issued immediately confirming the equipment type, quantity and price, and indicating an estimated delivery date. Please read this acknowledgment carefully. Any unacceptable discrepancy between the purchase order and the acknowledgment should be reported immediately to the local sales office.

## SHIPPING

The standard FOB point for all orders placed in the United States is Chestnut Ridge, New York except for GSA orders, where FOB is destination. The standard shipping method for most products is via two-day parcel service. Some products require either air freight or motor freight.

Special shipping instructions should be arranged prior to placing a purchase order so that any additional shipping charges are properly taken into account.

## TERMS

**Domestic Orders:** Payment terms are "Net 30-Days, acceptance period included" for all orders originating within the United States. The 30-day period begins on the actual shipping date. Any exception to these payment terms should be requested before placing a purchase order. Credit references will be required for new customer accounts. GSA Prompt Payment Terms - 1% - 10 days. Net 30 days.

**Export Orders:** For orders placed directly with LeCroy's main location in Chestnut Ridge, New York in U.S. dollars, payment terms for orders less than \$5,000 are via 30-day date draft, acceptance period included. > \$5,000 - Irrevocable Letter of Credit in favor of LeCroy Corporation payable at The Chase Manhattan Bank, N.A., Letter of Credit Department, 4 Chase MetroTech Center, 8th floor, Brooklyn, New York 11245, U.S.A.

For orders placed in Swiss Francs directly with LeCroy's European Headquarters in Geneva, Switzerland, for digital oscilloscope products, payment terms for less than SFR 10,000 are 30-day date draft, acceptance period included. > SFR 10,000 - Irrevocable Letter of Credit drawn on Credit Suisse, Charmilles - Balexert, Geneva, Switzerland.

Terms for orders placed with LeCroy export sales subsidiaries are Net 30-days, unless other special arrangements have been made in advance.

An end use statement is required for any item purchases in the U.S.A. that will be exported.



## Glossary of Technical Terms

**Acquisition Time:** In a sample-and-hold or track-and-hold circuit, the time required after the sample or track command for the output to slew through a full scale voltage change and settle to its final value to within a specified error band.

**ADC:** Analog-to-digital converter.

**Aliasing:** Whenever a dynamic signal is synchronously sampled, a possibility of misunderstanding its frequency content exists. This difficulty is termed "aliasing", and occurs whenever the sampling rate is less than twice the highest frequency component in the signal being measured.

**AND:** Logical designation or circuit function meaning that all inputs must be in the TRUE state for a TRUE output.

**Aperture Jitter:** In a sample-and-hold or ADC, the jitter between the time of the sample (or convert) command pulse and the time the input signal is actually sampled. This jitter is usually due to thermal noise. It leads to an uncertainty in the sampled amplitude equal to  $\Delta t \times dV/dt$  where  $\Delta t$  is the aperture jitter, and  $dV/dt$  is the rate of change of the input voltage at the time of sampling. The terms aperture jitter and aperture uncertainty are often used interchangeably.

**Aperture Uncertainty:** In a sample-and-hold or ADC, the total uncertainty in the time of the sample (or convert) command pulse and the time the input signal is actually sampled, due to all causes including noise, signal amplitude dependent delay variation (as in a flash ADC), temperature, etc. Often used interchangeably with aperture jitter, but aperture uncertainty is the more inclusive term.

**Area:** In a time domain DSO waveform measurement, area is the sum of the sampled values between the cursors times the duration of a sample.

**Artifact Rejection:** Used in summation averaging to exclude waveforms which have exceeded the dynamic range of recording system.

**Automatic Setup:** In an oscilloscope, automatic scaling of the time base, trigger, and sensitivity settings. Provides a stable display of repetitive input signals.

**Average:** See Mean Value, Summation Averaging and Continuous Averaging.

**Bandwidth:** In normal use, the frequency range over which the gain of an amplifier or other circuit does not vary by more than 3 dB.

**BER:** See BIT ERROR RATE.

**Binning:** A technique for combining points in a histogram to be compatible with the resolution of the display device.

**Bit:** An abbreviation of "binary digit", one of the two numbers, 0 and 1, used to encode data. A bit is often expressed by a high or low electrical voltage.

**Bit Error Rate:** Ratio of the number of bits of a message incorrectly received to the total number received.

**Blanking:** Setting an output signal to its quiescent level for the duration of the blanking input signal. (Not the same as RESET).

**Bridged Outputs:** Parallel output connections which are internally tied common from one signal source.

**Byte:** A group of eight bits used to encode a single letter, number or symbol.

**Cascade Display:** An oscilloscope display of a series of measured traces extending vertically with the first at the top to the last on the bottom. LeCroy's ScopeStation can display up to 24 traces in its Cascade display mode.

**Cascading:** Using units in series to augment a desired characteristic (e.g., amplification, number of inputs, etc.).

**CCD:** Charge Coupled Device. An integrated circuit which allows the transfer of a variable amount of charge through a series of cells; an analog shift register.

**Channel:** 1. A path through an arrangement of components (modules and electrical and/or optical cabling) along which signals can be sent (e.g., a data channel, voice channel, etc.).

2. A path through a single module often containing many identical parallel paths (e.g., "12-channel amplifier" usually implies a module with 12 identical amplifiers).

3. A band of amplitudes, frequencies, or time domains, as when a general region of interest is divided into many small slices (also called bins). (For example, a multichannel analyzer is an instrument that accepts a train of signals and sorts them into their appropriate bins or channels.)

NOTE: in referring to ADCs, there is often confusion whether definition 2 or 3 applies. A 256 channel ADC may mean 256 independent ADCs in one module or may mean a single ADC with 256 ( $2^8$ ) amplitude bins or channels (usually referred to as an 8-bit ADC).

**Channel Paralleling:** Analogous to paralleling outputs. Two or more channels give exactly the same output as a function of all the inputs to the given channels.

**Channel Profile:** A measure of intrinsic ADC or TDC noise, normally expressed as the nominal width at a defined height of the probability vs. input distribution of the channel.

**Charge Sensitive:** A device in which the output is directly proportional to the total integrated charge contained in the input pulse. A nominal integrating time must be specified.

**Clamping:** Holding a circuit point to some reference level (frequently ground) by means of a low-impedance element such as a saturated transistor, FET, forward-biased diode, relay, etc.

**Coherent Gain:** The normalized coherent gain of a filter corresponding to each window function is 1.0 (0 dB) for the Rectangular window and less than 1.0 for other windows. It defines the loss of signal energy due to the multiplication by the window function.

## Glossary of Technical Terms

**Common Mode Range:** The maximum range (usually voltage) within which differential inputs can operate without a loss of accuracy.

**Common Mode Rejection Ratio:** The ratio of the common-mode input voltage to the output voltage expressed in dB. The extent to which a differential amplifier does not provide an output voltage when the same signal is applied to the both inputs.

**Common Mode Signal (Noise):** The signal (usually noise) which appears equally, and in phase on each of the differential signal conductors to ground. See DIFFERENTIAL INPUT

**Continuous Averaging:** Sometimes called exponential averaging the technique consists of the repeated addition, with unequal weight, of successive source waveforms. Each new waveform is added to the accumulated average according to the formula:

$$S(i,\text{new}) = N/(N+1) \times [S(i,\text{old}) + 1/(N+1) \times [W(i)]]$$

where

i	index over all data points of the waveforms
W(i)	newly acquired waveform
S(i,old)	old accumulated average
S(i,new)	new accumulated average
N	Weighting factor (1,3,7...)

**Control and Status Register (CSR):** A register used to control the operation of a device and/or record the status of an operation.

**Conversion Cycle:** Entire sequence involved in changing data from one form to another, e.g. digitizing an analog quantity, changing binary data to BCD, etc.

**Conversion Time:** The amount of time taken to measure an analog phenomenon (e.g., a time duration, peak waveform voltage, quantity of charge within a pulse, etc.) and have its digital representation ready for readout.

**Crosstalk:** Unwanted coupling of a signal from one channel to another.

**Cursor:** A visible marker that identifies a horizontal and/or vertical position on an oscilloscope display. LeCroy DSO's offer "waveform riding" cursors which conveniently give both the horizontal and vertical values without selecting one or the other.

**DAC:** Digital-to-analog converter.

**Data Logger:** An instrument which accepts input signals (usually slow analog), digitizes them, and stores the results in memory for later readout. The digital equivalent of a strip-chart recorder.

**DC:** Direct current. Normally means a voltage or current which remains constant.

**DC Level Shift:** A change in the nominal DC voltage level present in a circuit.

**DC Offset:** See DC LEVEL SHIFT. This term may imply that the shift is intentional, for example, adjustable by a control knob.

**DC Overload:** An overload signal of long duration compared to the normal input pulse width or duty ratio of a circuit.

**Dead Time:** In a digital oscilloscope, the dead time is the time from the end of one acquisition of data to the start of the next acquisition.

**Decimation:** The process of reconstructing a source waveform with a reduced number of data points by using only every Nth data point, where N is an integer.

**Differential Input:** A circuit with two inputs that is sensitive to the algebraic difference between the two.

**Differential Linearity:** A term often inappropriately used to mean differential non-linearity.

**Differential Non-Linearity:** 1. The percentage departure from the average of the slope of the plot of output versus input from the slope of a reference line.

2. The percentage of variation in ADCs or TDCs from the mean of the analog (or time) width of any single digital step. Usually measured by driving the input with a large number of random amplitude pulses and then measuring the relative number of events in each digital bin.

**Differential Output:** A circuit with two outputs supplying one normal and one complementary level of output signal.

**Differential Pulses:** Two opposite polarity pulses coincident in time.

**Dithering:** Typically used when averaging signals (which have low noise content) to improve vertical resolution and decrease the effects of an ADCs non-linearities. The technique applies different offsets to each incoming waveform to ensure the signal is not always digitized by the same portion of the ADC. The offsets must be subtracted from the recorded signals before being included in the summed average.

**Digital Filtering:** The manipulation of digital data to enhance desirable and remove undesirable aspects of the data.

**Double-Pulse Resolution:** The minimum input pair spacing at which a comparator responds properly to the second of a pair of pulses.

**DPR:** See DOUBLE-PULSE RESOLUTION.

**Dropout Trigger:** A trigger that occurs if the input signal drops out for a time period longer than a preset amount (between 25 nsec to 20 sec on some LeCroy DSOs). Very useful for triggering on microprocessor crashes, network hangups, bus contention problems or other phenomena where a signal stops occurring.

**Duty Cycle:** A computed value in digital scopes, representing the average duration above midpoint value as a percentage of the period for time domain waveforms.



## Glossary of Technical Terms

**Dynamic Range:** The ratio of the largest to smallest signal which can be accurately processed by a module.

**Dynamic RAM (DRAM):** A random access memory in which the internal memory must be refreshed periodically.

**ECL:** Emitter-coupled logic, an unsaturated logic performed by emitter-coupled transistors. Normally, ECL LOGICAL 1 = -1.6 V and LOGICAL 0 = -0.8 V.

**EMI:** Electromagnetic interference caused by current or voltage induced into a signal conductor by an electromagnetic field in the conductor's environment.

**ENBW (Equivalent Noise Bandwidth):** For a filter associated with each frequency bin, ENBW is the bandwidth of an equivalent rectangular filter (having the same gain at the center frequency) which would collect the same power from a white noise signal.

**Enhanced Resolution (ERES):** A facility in LeCroy DSOs to increase the amplitude resolution of single shot waveform measurements. This technique, which applies digital filtering to achieve resolution enhancement at a reduced bandwidth, is optimum when the sampling rate of the instrument exceeds that required for the input signal bandwidth. For repetitive signals, either ERES or Signal Averaging, or both, can be used to achieve higher resolution with substantially smaller loss of bandwidth than for single shot signals.

**Envelope:** The maximum, minimum, or maximum and minimum values of a sequence of measured waveforms. In LeCroy DSOs, the number is programmable from 1 to  $10^6$ .

**EPROM:** Erasable programmable read-only memory. An integrated circuit memory array that is made with a pattern of either all logical zeros or ones and has a pattern written into it by the user with a special hardware program.

**Equivalent Time Sampling (EQT):** Equivalent Time Sampling (EQT or sometimes ETS) is a means of exploiting the aliasing phenomenon to increase the usable bandwidth of a digitizer by making it appear to sample more rapidly than its maximum single shot sample rate. Works only with stable, repetitive signals.

**Extrema:** The computation of a waveform envelope, by repeated comparison of successive waveforms, of all maximum points (roof) and all minimum points (floor). Whenever a given data point of the new waveform exceeds the corresponding maximum value in the roof record, it is used to replace the previous value. Whenever a given data point of the new waveform is smaller than the corresponding floor value, it is used to replace the previous value.

**Fall Time:** Unless otherwise defined, the time required for a pulse to go from 90% to 10% of full amplitude. Can also refer generally to the trailing edge of a pulse.

**Fan-in:** The mixing of more than one input to obtain one of the following outputs: 1. Linear — a circuit which linearly adds the amplitudes of more than one input signal and cre-

ates an output signal equal to the algebraic sum of the inputs; or 2. Logic — a circuit with more than one input which gives a logic output signal whenever a logical signal appears in any input (equivalent to a logical OR function.)

**Fan-Out:** The reproduction of an input signal at more than one output.

**Fast Fourier Transform (FFT):** In signal processing applications, a Fast Fourier Transform is a mathematical algorithm which takes a discrete source waveform, defined over N points, and computes N complex Fourier coefficients, which are interpreted as harmonic components of the input signal. For a "real" source waveform (imaginary part equals 0), there are N/2 independent harmonic components.

**Feedthrough:** Unwanted signal which passes a closed gate, or disabled input.

**FFT:** See Fast Fourier Transform.

**FFT Frequency Bins:** A Fast Fourier Transform (FFT) corresponds to analyzing the input signal with a bank of N/2 filters, all having the same shape and width, and centered at N/2 discrete frequencies. Each filter collects the signal energy that falls into the immediate neighborhood of its center frequency, and thus it can be said that there are N/2 "frequency bins". The distance, in Hz between the center frequencies of two neighboring bins is always:  $\Delta f = 1/T$ , where T is the duration of the time-domain records in seconds. The nominal width of bin is equal to  $\Delta f$ .

**FFT Frequency Range:** The range of frequencies computed and displayed in a FFT is 0 Hz to the Nyquist frequency.

**FFT Frequency Resolution:** In a narrow sense, the frequency resolution is equal to the bin width,  $\Delta f$ . That is, if the input signal changes its frequency by  $\Delta f$ , the corresponding spectrum peak will be displaced by  $\Delta f$ . For smaller changes of frequency, only the shape of the peak will change.

However, the effective frequency resolution (i.e., the ability to resolve two signals whose frequencies are almost the same) is further limited by the use of window functions. The ENBW value of all windows other than the rectangular is greater than  $\Delta f$ , i.e. greater than the bin width.

**FFT Number of Points:** FFT is computed over the number of points (Transform Size) whose upper bound is the source number of points. FFT generates spectra having N/2 output points.

**FFT Total Power:** Area under the power density spectrum in frequency domain measurements.

**FIFO:** First-in, first-out shift registers (sometimes called first-in, first-out memory).

**Filter:** An electronic circuit or digital data manipulation routine that either enhances desirable or removes undesirable aspects of an analog waveform or its digital representation. Filters are used to block specific frequency components from

## Glossary of Technical Terms

passing through a circuit, to linearize otherwise identical components (such as CCDs) used in a common circuit, or to perform waveform integration, differentiation, or smoothing, just to name a few types.

**Flash ADC:** A very fast analog-to-digital converter in which the analog signal simultaneously is compared to  $2^n - 1$  different reference voltages, where  $n$  is the ADC resolution. Also called a parallel converter. A very fast analog-to-digital converter usually consisting of a large set of fast comparators and associated logic.

**Floor:** The record of points which make the bottom (or minimum) of an envelope created from a succession of waveforms.

**FWHM:** Full-Width Half Maximum. The width of a pulse or waveform at 50% amplitude used to measure the duration of a signal.

**Gate:** 1. A circuit element used to provide a logical function (e.g., AND, OR); 2. An input control signal or pulse enabling the passage of other signals.

**Glitch:** A spike or short-time duration structural aberration on an otherwise smoother waveform that is normally characterized by more gradual amplitude changes. In digital electronics, where the circuit under test uses an internal clock, a glitch may be considered to be any pulse narrower than the clock width.

**Glitch Trigger:** A trigger on pulse widths smaller than a given value.

**Ground Loop:** A long ground connection along which voltage drops occur due either to heavy circuit current or external pick-up, with the result that circuit elements referred to different points along it operate at different effective ground references.

**Hardware Option:** An option available by soldering an appropriate connecting wire into the circuit.

**HF Sync:** Reduces the trigger rate by including a frequency divider in the trigger path, enabling the input trigger rate to exceed the maximum for repetitive signals.

**Histogram:** A graphical representation of data such that the data is divided into intervals or bins. The intervals or bins are then plotted on a graph where the height is proportional to the number of data points contained in each interval or bin.

**Hold-off by Events:** Selects a minimum number of events between triggers. An event is generated when the trigger source meets its trigger conditions. A trigger is generated when the trigger condition is met after the selected number of events from the last trigger. The hold-off by events is initialized and started on each trigger.

**Hold-off by Time:** Selects a minimum time between triggers. A trigger is generated when the trigger condition is met after the selected delay from the last trigger. The timing for the delay is initialized and started on each trigger.

**HPGL:** Hewlett-Packard Graphics Language Format, Hewlett-Packard Company, San Diego, CA.

**Hybrid Circuit:** A small, self-contained high-density circuit element usually consisting of screened or deposited conductors, insulating areas, resistors, etc., with welded or bonded combinations of discrete circuit elements and integrated circuit chips.

**IC:** Integrated Circuit. A self-contained multiple element circuit such as a monolithic or hybrid.

**ICL:** LeCroy's Internal Command Language developed to customize and/or automate operation of the 7200 Series DSOs.

**Importance Sampling:** Increasing the sample rate during certain periods of recording to obtain denser sampling information. (A technique often used with transient recorders to optimize use of memory areas).

**Integral Linearity:** A term often used inappropriately to mean integral non-linearity.

**Integral Non-Linearity:** Deviation of ADC response from an appropriate straight line fit. The specification is sometimes defined as maximum deviation expressed as a fraction of full scale. More recent ADCs have a specification expressed as a percent of reading plus a constant.

**Interchannel Dead Time:** The time required to switch from one circuit path to another.

**Interleaved Clocking:** Supplying clock pulses of equal frequency but different identical circuits or instruments in order to increase the system sample rate. For example, use of two transient recorders with inputs in parallel but complementary clocks to allow operation at twice the maximum rate of a single unit.

**Interval Trigger:** Selects an interval between two edges of the same slope. The trigger can be generated on the second edge if it occurs *within* the selected interval or *after* the selected interval. The timing for the interval is initialized and restarted whenever the selected edge occurs.

**Isolation Amplifier:** A circuit which accepts single-ended signals, yet its isolated ground return offers common mode rejection properties similar to a fully differential input. In general, the common mode rejection is effective only for low frequencies.

**Jitter:** Short-term fluctuations in the output of a circuit or instrument which are independent of the input.

**Leakage:** When observing the Power Spectrum of a sine wave having an integral number of periods in the time window using the Rectangular Window, leakage is the broadening of the base of the peak spectral component that accurately represents the source waveform's amplitude.

**Learn Mode:** The ability of a software program or instrument to interpret and store a sequence of key presses and/or knob



## Glossary of Technical Terms

changes in a format it will recognize and properly execute when later called upon.

**LED:** Light Emitting Diode.

**Limiter:** A circuit element which limits the amplitude of an input (used for input protection, pulse standardizing, etc.).

**Logical 1:** A signal level indicating the TRUE state; corresponds to the unit being set (i.e. if interrogated, the answer is yes).

**Logical 0:** A signal level indicating the FALSE state; corresponds to the unit NOT being set (i.e. if interrogated, the answer is no).

**Long-Term Stability:** Refers to stability over a long time, such as several days or months.

**MCA:** Multichannel Analyzer (e.g., pulse height analyzer).

**Mean Value:** Average or DC level of all data points selected in a waveform. i.e.,

$$\frac{1}{N} \sum_{i=1}^N V_i$$

**Median Value:** The data value of a waveform above and below which there are an equal number of data points.

**Mode Value:** The most frequently occurring data value of a waveform.

**Monolithic IC:** An integrated circuit whose elements (transistors, diodes, resistors, small capacitors, etc.) are formed in situ upon or within a semiconductor substrate.

**Monotonic:** A function with a derivative that does not change sign.

**Multiplexer:** A device used to selectively switch a number of signal paths to one input or output.

**NAND:** An AND circuit, except with a complementary (negative true) output.

**Negation:** The process of transposing all negative values into positives and all positive values into negatives.

**Noise Equivalent Power:** NEP (W); the rms value of optical power which is required to produce unity rms signal-to-noise ratio.

**NOR:** An OR circuit, except with a complementary (negative true) output.

**Nyquist Frequency:** The Nyquist frequency ( $f/2$ ) is the maximum frequency that can be accurately measured by a digitizer sampling at a rate of ( $f$ ). In other terms, a digitizer sampling at a rate of ( $f$ ) cannot measure an input signal with bandwidth components exceeding  $f/2$  without experiencing "aliasing" inaccuracies.

**Offset:** The amount by which an analog or digital output or input baseline is shifted with respect to a specific reference value (usually zero).

**OR:** A logic circuit having the property that if at least one input is true, the output is true.

**Overshoot, Negative:** A time domain parameter in waveform measurements, equal to the base value of a waveform minus the minimum sample value, expressed as a percentage of the amplitude.

**Overshoot, Positive:** A time domain parameter in waveform measurements, equal to the maximum sample value minus the top value, expressed as a percentage of the amplitude. The top value is the most probable state determined from a statistical distribution of data point values in the waveform.

**Parallel Converter:** A technique for analog-to-digital conversion in which the analog signal is simultaneously compared to  $2^n - 1$  different reference voltages, where  $n$  is the ADC resolution.

**Pass/Fail Testing:** Post-acquisition testing of a waveform against a reference mask or of waveform parameters against reference values.

**Pattern Trigger:** The pattern trigger logically combines the states of the trigger inputs. The combination, called a pattern, is defined as the logical AND of the trigger states. A trigger state is either high or low; high when a trigger source is greater than the trigger level and low if it is less than the trigger level. For example, the pattern can be defined as present when the trigger state for channel 1 is high, 2 is low, and EXT is high. If any are not met, the pattern state is considered absent.

**Pattern Width:** Selects a pattern width, either maximum or minimum. If the width is less than the selected width, the trigger is generated when the pattern ends. If the width is greater than the selected width, the trigger is generated when the pattern ends. The timing for the pattern width is initialized and restarted at the beginning of the pattern.

**PCMCIA:** Personal Computer Memory Card Industry Association standard for PC memory cards. Also known as JEIDA in Japan.

**PCX:** The PC Paintbrush Format for graphic images, ZSoft Corporation, Marietta, GA.

**Peak Spectral Amplitude:** Amplitude of the largest frequency component in a waveform in frequency domain analysis.

**Peak Sensing ADC:** An analog-to-digital converter which measures only peaks of waveforms occurring within the measurement period.

**Period:** A full period is the time measured between the first and third 50% crossing points (mesial points) of a cyclic waveform.

## Glossary of Technical Terms

**Persistence:** An display operating mode of a DSO where a user-determined number of measured traces remain on the display without being erased and overwritten.

**PHA:** Pulse Height Analyzer. A device that gives a measure of the amplitude of a signal applied to its input.

**Picket Fence Effect:** If a sine wave has a whole number of periods in the time domain record, the Power Spectrum obtained with the Rectangular window will have a sharp peak, corresponding exactly to the frequency and amplitude of the sine wave. If it does not, the spectrum obtained will be lower and broader. The highest point in the power spectrum can be 3.92 dB lower (1.57 times) when the source frequency is halfway between two discrete bin frequencies. This variation of the spectrum magnitude is called the Picket Fence Effect (the loss is called the Scallop Loss). All window functions compensate this loss to some extent, but the best compensation is obtained with the Flat Top window.

**Power Spectrum:** The Power Spectrum ( $V^2$ ) is the square of the Magnitude spectrum. The Power Spectrum is displayed on the dBm scale, with 0 dBm corresponding to  $V_{ref}^2 = (0.316 V_{peak})^2$ , where  $V_{ref}$  is the peak value of the sinusoidal voltage which is equivalent to 1 mW into 50  $\Omega$ .

**Power Density Spectrum:** The Power Density Spectrum ( $V^2/Hz$ ) is the Power Spectrum divided by the equivalent noise bandwidth of the filter, in Hz. The Power Density spectrum is displayed on the dBm scale, with 0 dBm corresponding to  $(V_{ref}^2/Hz)$ .

**Pretrigger Sampling:** A design concept used in transient recording in which a predetermined number of samples taken before a stop trigger are preserved.

**Pulse Width:** Determines the duration between the Pulse Start (mesial point, i.e. the 50% magnitude transition point, on the leading edge) and the Pulse Stop (mesial point on the trailing edge) of a pulse waveform.

**Pulse Start:** The 50% magnitude transition point (mesial point) on the leading edge of a pulse waveform.

**Pulse Stop:** The 50% magnitude transition point (mesial point) on the trailing edge of a pulse waveform.

**Pulse Trigger:** Selects a pulse width, either maximum or minimum. The trigger is generated on the selected edge when the pulse width is either greater than or less than the selected width. The timing for the width is initialized and restarted on the edge opposite to the edge selected.

**Quasi-Differential:** An input which accepts single-ended signals, yet its isolated ground return offers common mode rejection properties similar to a fully differential input. In general, the common mode rejection is effective only for low frequencies.

**RAM:** A memory in which each data address can either be written into or read from at any time.

**Random Interleaved Sampling (RIS):** Random Interleaved Sampling is one method of Equivalent Time Sampling. Acting upon stable, repetitive signals, it represents the process of storing different full sampling sweeps in a DSO or digitizer system, where each sweep is slightly offset from the other to achieve a higher effective sampling rate than the single shot rate. A major advantage of RIS over other EQT (ETS) techniques is "pretrigger viewing."

**Real Time:** A process that occurs without having to pause for internal conversions and references. Real time processes usually have little or no intrinsic dead time and are able to proceed at a rate which permits almost simultaneous transitions from inputs to outputs.

**Reciprocal:** The division of unity by the data value being processed.

**Reflection Coefficient:** The amount of signal amplitude that is reflected from an input, expressed as a percentage of the original input signal.

**Resolution:** The minimum measurable increment, such as one bit level of an ADC.

**Reverse Termination:** An output so constructed that pulses reflected back from the rest of the system meet a matching impedance and are absorbed.

**RF:** Radio Frequency. Normally in the megahertz range.

**RFI:** Radio Frequency Interference. A special case of EMI wherein the field causing the induced signal falls into the radio portion of the electromagnetic spectrum.

**Rise Time:** Unless otherwise defined, the time required for a pulse to go from 10% to 90% of full amplitude. Can also refer generally to the leading edge of a pulse.

**RMS (Root Mean Square):** Is derived from the square root of the average of the squares of the magnitudes, for all the data as described above.

$$\sqrt{\frac{1}{N} \sum_{i=1}^N}$$

For time domain waveforms, the square root of the sum of squares divided by the number of points for the part of the measured waveform between the cursors. For histogram waveforms, the square root of sum of squares divided by number of values computed on the distribution.

**ROM:** Read only memory is any type of memory which cannot be readily rewritten. The information is stored on a permanent basis and used repeatedly. Usually randomly accessible.

**Roof:** The record of points which make the top (or maximum) of an envelope created from a succession of waveforms.

**Sample and Hold:** A circuit that on command stores on a capacitor the instantaneous amplitude of an input signal.



## Glossary of Technical Terms

**Sampling Frequency:** The clock rate at which samples are taken during the process of digitizing an analog signal in a DSO or digitizer.

**SCA:** Single channel analyzer. A circuit which responds only to input signals falling between an upper and lower amplitude level.

**Scallop Loss:** Loss associated with the picket fence effect.

**Sensitivity:** 1. The minimum signal input capable of causing an output signal with the desired characteristics.

2. The ratio of the magnitude of the instrument response to the input magnitude (e.g., a voltage ADC has a sensitivity that is usually measured in counts/mV). Often, sensitivity is referred to the input and is therefore stated as the inverse.

**Shot Noise:** Noise caused by current fluctuations, due to the discrete nature of charge carriers and random emission of charged particles from an emitter. Many refer to shot noise loosely, when speaking of the mean square shot noise current (amps) rather than a noise power (watts).

**Smart Trigger:** The Smart Trigger allows setting additional qualifications before a trigger is generated. These qualifications can be used to capture rare phenomena such as glitches or spikes, specific logic states or missing bits. One qualification can include, for example, generating a trigger only on a pulse wider or narrower than specified.

**Smoothing, N-Point** The process of evening out the display of a waveform by displaying a moving average of "N" adjacent data points added to each other.

**SNR:** Signal-to-noise ratio is the ratio of the magnitude of the signal to that of the noise.

**Square:** The process of multiplying a value by itself.

**Stage Delay:** The time delay in circuit between input and output, usually measured between the front edges (half maximum) of the respective signals.

**Standard Deviation:** Is the standard deviation of the measured points from the mean. It is calculated from the following formula:

$$\frac{1}{N-1} \sum_{i=1}^N (V_i - \text{mean})^2$$

**Standard Trigger:** Standard Trigger causes a trigger to occur whenever the selected trigger source meets its trigger conditions. The trigger condition is defined by the trigger level, coupling, high frequency sync, and slope.

**State Qualified:** State qualified triggering generates a trigger when the trigger source meets its trigger conditions during the selected pattern. A pattern is defined as a logical AND combination of trigger states. A trigger state is either high or low; high when a trigger source is greater than the trigger level and low if it is less than the trigger level.

**Stop Trigger:** A pulse which is used to stop a transient recording or similar sequence.

**Stroke:** A digital signal used to read or write data or initiate a conversion cycle at a controlled time.

**Summation Averaging:** The repeated addition, with equal weight, of successive waveforms divided by the total number of waveforms acquired.

**TDC:** Time-to-digital converter.

**Terminate:** Normally, to provide a matching impedance at the end of coaxial cable to prevent reflections.

**Test Template:** A general form of waveshape limit test, which defines an arbitrary limit (or non-uniform tolerance) on each measured point in a waveform.

**Threshold:** The voltage or current level at which a circuit will respond to a signal at its input. Also referred to as trigger level.

**TIFF:** Tagged Image File Format. Industry standard for bit-mapped graphic files.

**Time Between Patterns:** Selects a delay, either maximum or minimum, between exiting one pattern and entering the next. The trigger is generated on entering the second pattern either within the selected time or after the selected minimum time.

**Timeout:** A Timeout occurs when a protective timer completes its assigned time without the expected event occurring. Timeouts prevent the system from waiting indefinitely in case of error or failure.

**Time Qualified:** Time qualified triggering generates a trigger when the trigger source meets its trigger condition after entering or exiting the pattern. The trigger can occur even if the pattern disappears before the trigger meets its trigger conditions. See "Pattern Trigger."

**Tolerance Mask:** A form of waveshape limit test which defines a maximum deviation equal to a uniform tolerance on each measured point in a waveform.

**Track and Hold:** A circuit that precedes an analog-to-digital converter which has the ability on command to store instantaneous values of a rapidly varying analog signal. Allows the ADC to accurately digitize within tighter time domains.

**Transient Recorder:** See Waveform Digitizer.

## Glossary of Technical Terms

**TTL:** Transistor-transistor logic. Signal levels defined as follows: LOGICAL 0 = 0 to 0.8 V and LOGICAL 1 = 2.0 to 5.0 V.

**Trend:** Plot of a parameter value or other characteristic of a measurement over a period of time. Such a function is routinely performed in LeCroy Series 7200 DSOs, where statistics and parameters can be applied to the trend itself.

**Twisted Pair:** Cable composed of two isolated wires twisted together. It features high noise immunity because the same amount of noise is induced on both wires. It is suitable for differential pulse pair transmission.

**Waterfall Display:** Another name for "cascade display." (In LeCroy DSOs, an oscilloscope display of a series of measured traces extending vertically with the first at the top to the last on the bottom. LeCroy's ScopeStation can display up to 24 traces in its cascade display mode.)

**Waveform Digitizer:** An instrument which samples an input waveform at specified intervals, digitizes the analog values at the sampled points and stores the results in a digital memory.

**Window Functions:** Used to modify the spectrum of a truncated waveform prior to Fourier analysis. Alternately, window functions determine the selectivity (filter shape) in a Fourier transform spectrum analyzer. In LeCroy scopes, all window functions belong to the sum of cosines family with 1 to 3 non-zero cosine terms ( $W = \sum a_m \cos(2\pi k/N)$ , where N is the # of points in the decimated source waveform, and k is the time index).

**X-Y Display:** A plot of one trace against another trace. This technique is normally used to compare the amplitude information of two waveforms. It can reveal phase and frequency information through the analysis of patterns called Lissajous figures.



## Credits

Apple and Macintosh are registered trademarks of Apple Computer, Incorporated.

BubbleJet is a registered trademark of Canon USA, Incorporated.

Centronics is a registered trademark of Data Computer Corporation.

Compaq, Compaq III and Compaq 386 are trademarks of Compaq Computer Corporation.

EASYWAVE is a registered trademark of LeCroy Corporation.

Epson MX, FX, and LQ are a registered trademarks of Seiko Epson Corporation.

FASTGLITCH, WAVEFORM CATALYST, SMART Trigger and ScopeStation are trademarks of LeCroy Corporation.

Graphtec is a registered trademark of Graphtec Corporation.

HP, HPGL, ThinkJet, QuietJet, DeskJet, PaintJet and LaserJet are registered trademarks of Hewlett Packard Corporation.

IBM, IBM PC, IBM PC/XT, IBM PC/AT, and IBM Personal System 2 are registered trademarks of International Business Machines Corporation.

LabWindows and LabView are registered trademarks of National Instruments Corporation.

MathCad is a registered trademark of MathSoft Incorporated.

Microsoft, MS-DOS, QuickBasic and Windows are a registered trademarks of Microsoft Corporation

Novell and Netware are registered trademarks of Novell Corporation.

PC-2 and PC-2A are trademarks of National Instruments Incorporated.

PCX is a file format developed by ZSoft Corporation for use with PC paint programs.

Philips is a registered trademark of Philips Test & Measurement Incorporated.

PSPICE is a registered trademark of MicroSim Corporation.

Quantum is a registered trademark of Quantum Corporation.

Quantum Grand Prix™ 4.3 GB Disk Drive cover photo courtesy of Quantum Corporation.

SUN is a trademark of SUN Microsystems.

UNIX is a registered trademark of AT&T.

VAX, MicroVAX, VMS, QBUS, and UNIBUS are registered trademarks of Digital Equipment Corporation.

W.A.V.E. is a product of Vespine Division of Electronic Decisions Incorporated.

This page left intentionally blank



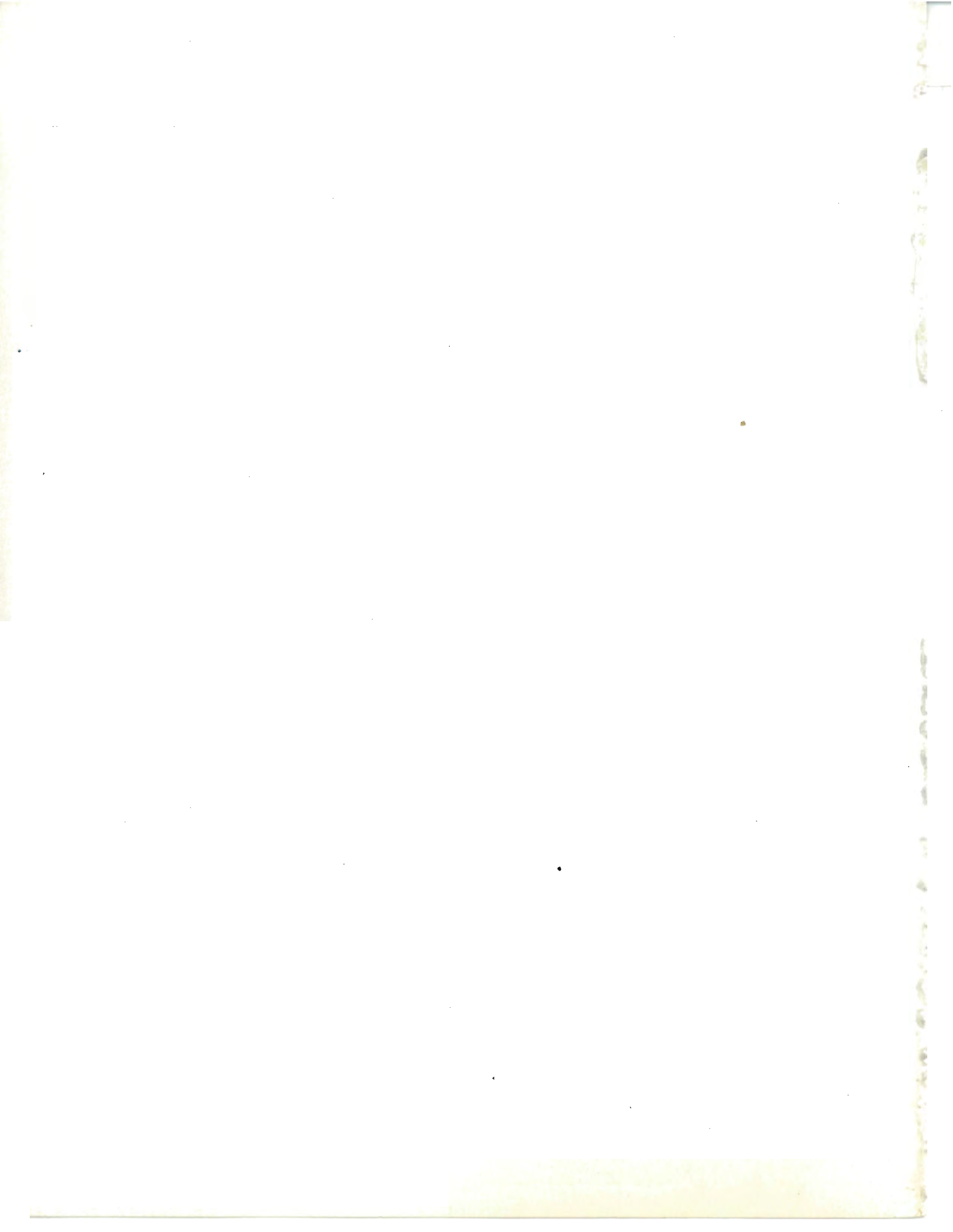

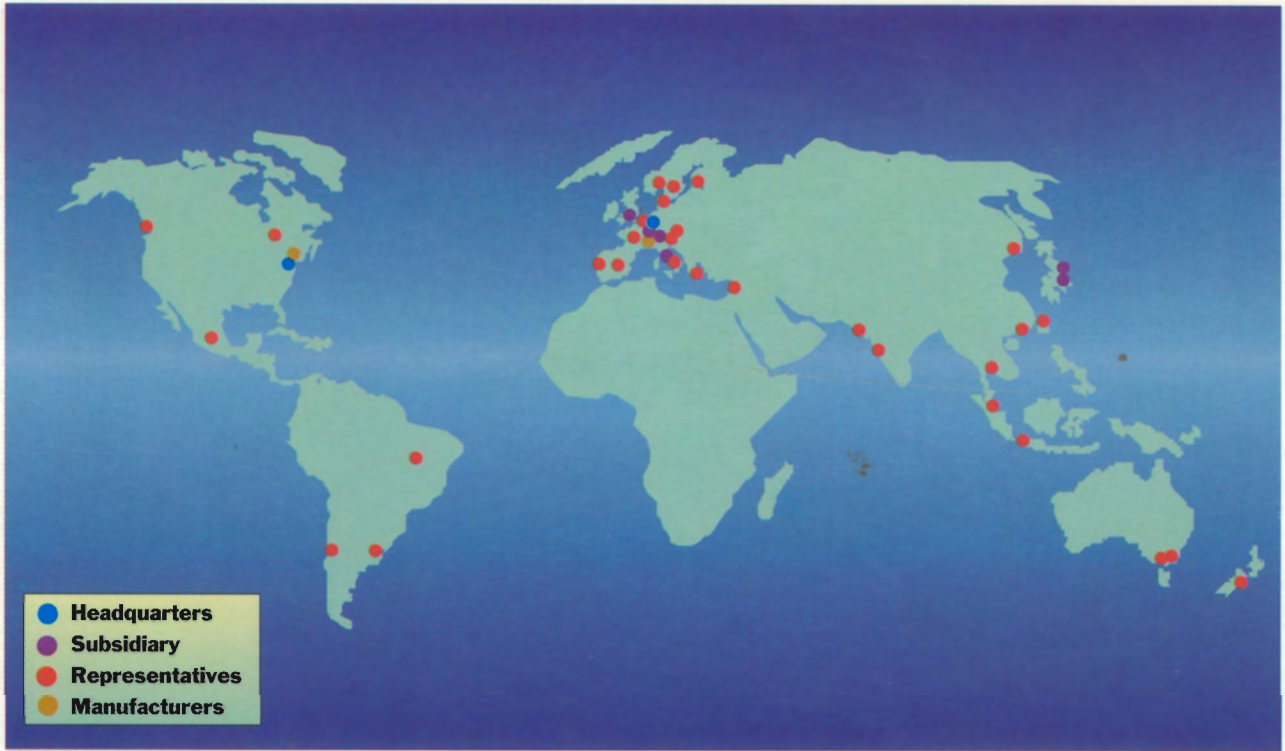

**LeCroy**

*Innovators in Instrumentation*